

# PowerLogic™ Power Meter PM5350

## User Guide

63230-401-203A5  
10/2020





# Safety Information

## Important Information

Read these instructions carefully and look at the equipment to become familiar with the device before trying to install, operate, service or maintain it. The following special messages may appear throughout this manual or on the equipment to warn of potential hazards or to call attention to information that clarifies or simplifies a procedure.



The addition of either symbol to a “Danger” or “Warning” safety label indicates that an electrical hazard exists which will result in personal injury if the instructions are not followed.



This is the safety alert symbol. It is used to alert you to potential personal injury hazards. Obey all safety messages that follow this symbol to avoid possible injury or death.

### **DANGER**

**DANGER** indicates an imminently hazardous situation which, if not avoided, will result in death or serious injury.

### **WARNING**

**WARNING** indicates a potentially hazardous situation which, if not avoided, can result in death or serious injury.

### **CAUTION**

**CAUTION** indicates a potentially hazardous situation which, if not avoided, can result in minor or moderate injury.

### **NOTICE**

**NOTICE** is used to address practices not related to physical injury. The safety alert symbol shall not be used with this signal word.

## Please Note

Electrical equipment should be installed, operated, serviced, and maintained only by qualified personnel. No responsibility is assumed by Schneider Electric for any consequences arising out of the use of this material.

A qualified person is one who has skills and knowledge related to the construction, installation, and operation of electrical equipment and has received safety training to recognize and avoid the hazards involved.

# Notices

## FCC Part 15 Notice

This equipment has been tested and found to comply with the limits for a Class A digital device, pursuant to Part 15 of the FCC Rules. These limits are designed to provide reasonable protection against harmful interference when the equipment is operated in a commercial environment. This equipment generates, uses, and can radiate radio frequency energy and, if not installed and used in accordance with the instruction manual, may cause harmful interference to radio communications. Operation of this equipment in a residential area is likely to cause harmful interference in which case the user will be required to correct the interference at his own expense.

This Class A digital apparatus complies with Canadian ICES-003.

# Table of Contents

<b>Chapter 1:</b>	<b>Introduction</b>	Power Meter Hardware .....	1
		Power Meter Parts and Accessories .....	2
		Box Contents .....	2
		Firmware .....	2
<b>Chapter 2:</b>	<b>Safety Precautions</b>	Before You Begin .....	3
<b>Chapter 3:</b>	<b>Operation</b>	Operating the Display .....	5
		How the Buttons Work .....	6
		Changing Values .....	6
		Icons .....	7
		LEDs .....	7
		Energy/Alarm LED .....	7
		Heartbeat/Communication LED .....	7
		Menu Overview .....	9
		Setting Up the Power Meter .....	10
		Power Meter Basic Setup .....	10
		Setting Up the Power System .....	10
		Supported Power System Configurations .....	11
		Overcurrent Protection .....	13
		Setting Up Voltage Connection and CT Options .....	13
		Setting Up the System Frequency .....	14
		Setting Up the Phase Rotation .....	15
		Power Meter Advanced Setup .....	16
		Setting Up the Load Timer Setpoint .....	16
		Setting Up the Peak Current Demand Over Last Year .....	17
		Power Meter Demand Setup .....	17
		Setting Up Power and Current Demand .....	18
		Select the Digital Input .....	19
		Power Meter Communication Setup .....	20
		Setting Up Communications .....	20
		Setting Up Alarms .....	20
		Setting Up I/O .....	21
		Power Meter HMI Setup .....	21
		Setting Up the Display .....	21
		Setting Up Regional Settings .....	23
		Setting Up Passwords .....	24
		Power Meter Clock Setup .....	24
		Setting Up the Clock .....	25
		Reset the Power Meter .....	25
		Global Resets .....	26
		Single Resets .....	27
<b>Chapter 4:</b>	<b>Metering</b>	Power Meter Characteristics .....	29
		MODBUS RS-485 .....	30
		Digital Outputs .....	30
		Digital Inputs .....	30
		Min/Max Values for Real-Time Readings .....	30
		Power Factor Min/Max Conventions .....	31
		Demand Readings .....	32
		Demand Calculation Methods .....	32
		Block Interval Demand .....	32
		Synchronized Demand .....	34
		Thermal Demand .....	35
		Predicted Demand .....	35
		Peak Demand .....	36

	Energy Readings .....	36
	Power Analysis Values .....	37
	View or Modify Configuration Data using ION Setup .....	38
<b>Chapter 5: Alarms</b>	About Alarms .....	39
	1-Second Alarms .....	40
	Unary Alarms .....	41
	Digital Alarms .....	41
	Multi Circuit Alarms .....	41
	Alarm Priorities .....	41
	Using an Alarm to Control a Relay Output .....	42
	Alarm Setup .....	42
	Setting Up 1-Second Alarms .....	43
	Setting Up Unary Alarms .....	45
	Setting Up Digital Alarms .....	46
	Viewing Alarm Activity and History .....	48
	Viewing Active Alarms and Alarm Counters .....	48
	Viewing Unacknowledged Alarms and the Alarm History Log .....	49
<b>Chapter 6: Input/Output Capabilities</b>	Digital Inputs .....	51
	Setting Up the Digital Inputs .....	52
	Setting Up the Digital Inputs in Normal Mode .....	53
	Setting Up the Digital Inputs in Demand Sync Mode .....	54
	Digital Outputs .....	55
	Setting Up the Digital Output .....	56
	Setting Up the Digital Output in External Mode .....	57
	Setting Up the Digital Output in Alarm Mode .....	58
	Setting Up the Digital Output in Demand Sync Mode .....	59
	Energy/Alarm LED .....	60
	Setting Up the Energy/Alarm LED .....	60
<b>Chapter 7: Maintenance and Troubleshooting</b>	Password Recovery .....	61
	Power Meter Memory .....	61
	Identifying the Firmware Version, Model, and Serial Number .....	61
	Additional Meter Status Information .....	62
	Meter .....	62
	Control Power .....	62
	Downloading Firmware .....	62
	Troubleshooting .....	63
	Heartbeat/Communication LED .....	63
	Getting Technical Support .....	64
	Register List .....	64
<b>Appendix A: Specifications</b>	Power Meter Specifications .....	65
<b>Appendix B: Communications Wiring</b>	Communications Capabilities .....	69
	Daisy-Chaining Devices to the Power Meter .....	69
<b>Appendix C: Power Factor Register Format</b>	Power Factor Register Format .....	71
<b>Appendix D: Command Interface</b>	Command Interface .....	73
	Using the Protected Command Interface .....	74
	Using the Unprotected Command Interface .....	75
<b>Appendix E: Multi Circuit Applications</b>	Overview .....	77
	Meter Identification .....	77
	Monitoring Circuits with Multi-Level Alarms .....	77
	Multi Circuit Menu Overview .....	79
	Basic Setup for Multi Circuit Mode .....	80
	Setting Up the Power System .....	80

---

Supported Power System Configurations .....	81
Setting Up Voltage Connection and CT Options .....	82
Metering .....	84
Multi Circuit Alarms .....	85
Setting Up Multi Circuit Alarms .....	86
Viewing Multi Circuit Alarm Activity and History .....	89
Multi Circuit Event Types .....	89
Multi Circuit Alarm on Phase .....	90
Multi Circuit Alarm Values .....	90
Command Interface with Multi-Level Alarms .....	90
Quick Read Block for Modbus Reads .....	90
Input/Output Capabilities .....	91
Monitoring for Tripped Status with a Digital Input .....	91
Digital Outputs in Multi Circuit Mode .....	92
LEDs .....	92
<b>Glossary</b> .....	
Terms .....	93
Abbreviations .....	95
<b>Index</b> .....	97
<b>China Standard Compliance</b> .....	99





# Chapter 1—Introduction

## Power Meter Hardware

Figure 1– 1 below shows the parts of the power meter. Table 1– 1 describes the parts.  
**Figure 1– 1 Parts of the power meter (rear panel door removed)**

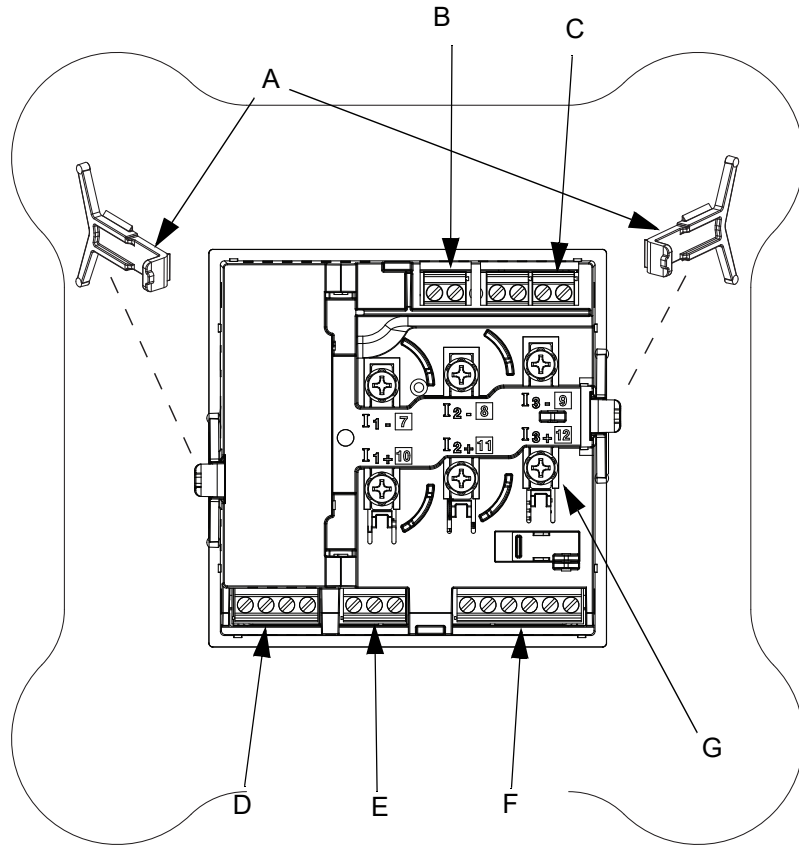

**Table 1– 1 Parts of the Power Meter**

Number	Part	Description
A	Retainer clips	Used to secure the power meter in place
B	Control power supply connector	Connection for control power to the power meter
C	Voltage inputs	Voltage metering connections
D	Digital outputs	Digital outputs (DO1 and DO2) connections
E	RS-485 port (COM1)	Used for communications with a monitoring and control system, can be daisy-chained to multiple devices
F	Digital inputs	Digital inputs (DI1-DI4) connections, whetting voltage supplied by power meter
G	Current inputs	Current metering connections

## Power Meter Parts and Accessories

Table 1–2 Power Meter Models

Description	Model Number
Power Meter with Integrated Display	PowerLogic™ Power Meter PM5350

## Box Contents

- One (1) power meter with retainer clips attached
- One (1) set of installation guides
- One (1) RS-485 Terminator (MCT2W)
- One (1) panel gasket
- One (1) certificate of calibration
- One (1) meter mounting template
- Three (3) screws (spare screws for CTs)

## Firmware

This user guide is written to be used with firmware version 2.00.0000. See “Identifying the Firmware Version, Model, and Serial Number” on page 61 for instructions on determining the firmware version.

## Chapter 2—Safety Precautions

### Before You Begin

This section contains important safety precautions that must be followed before attempting to install, service, or maintain electrical equipment. Carefully read and follow the safety precautions outlined below.

#### **DANGER**

##### **HAZARD OF ELECTRIC SHOCK, EXPLOSION, OR ARC FLASH**

- Apply appropriate personal protective equipment (PPE) and follow safe electrical work practices. See NFPA 70E in the USA or applicable local standards.
- Only qualified electrical workers should install this equipment. Such work should be performed only after reading this entire set of instructions.
- If the equipment is not used in a manner specified by the manufacturer, the protection provided by the equipment may be impaired.
- NEVER work alone.
- Do not use this device for critical control or protection applications where human or equipment safety relies on the operation of the control circuit.
- Before performing visual inspections, tests, or maintenance on this equipment, disconnect all sources of electric power. Assume that all circuits are live until they have been completely de-energized, tested, and tagged. Pay particular attention to the design of the power system. Consider all sources of power, including the possibility of backfeeding.
- Turn off all power supplying this device before working on it.
- Always use a properly rated voltage sensing device to confirm that all power is off.
- Do not exceed the device's ratings for maximum limits.
- Before closing all covers and doors, carefully inspect the work area for tools and objects that may have been left inside the equipment.
- When removing or installing panels, do not allow them to extend into the energized bus.
- The successful operation of this equipment depends upon proper handling, installation, and operation. Neglecting fundamental installation requirements may lead to personal injury as well as damage to electrical equipment or other property.
- NEVER bypass external fusing.
- NEVER short the secondary of a PT or VT.
- NEVER open circuit a CT; use the shorting block to short circuit the leads of the CT before removing the connection from the power meter.
- Before performing Dielectric (Hi-Pot) or Megger testing on any equipment in which the power meter is installed, disconnect all input and output wires to the power meter. High voltage testing may damage electronic components contained in the demand controller.
- This equipment should be installed in a suitable electrical enclosure.
- Always use grounded external CTs for current inputs.
- All external CT's and PT's should have reinforced insulation.

**Failure to follow these instructions will result in death or serious injury.**

1. Turn off all power supplying this device before working on it.
2. Always use a properly rated voltage sensing device to confirm that all power is off.



## Chapter 3—Operation

### Operating the Display

The power meter is equipped with a large, back-lit LCD display. It is designed to display up to six lines of information plus a row of menu options. Figure 3–1 shows the different parts of the power meter display.

**Figure 3–1: Power Meter Display**

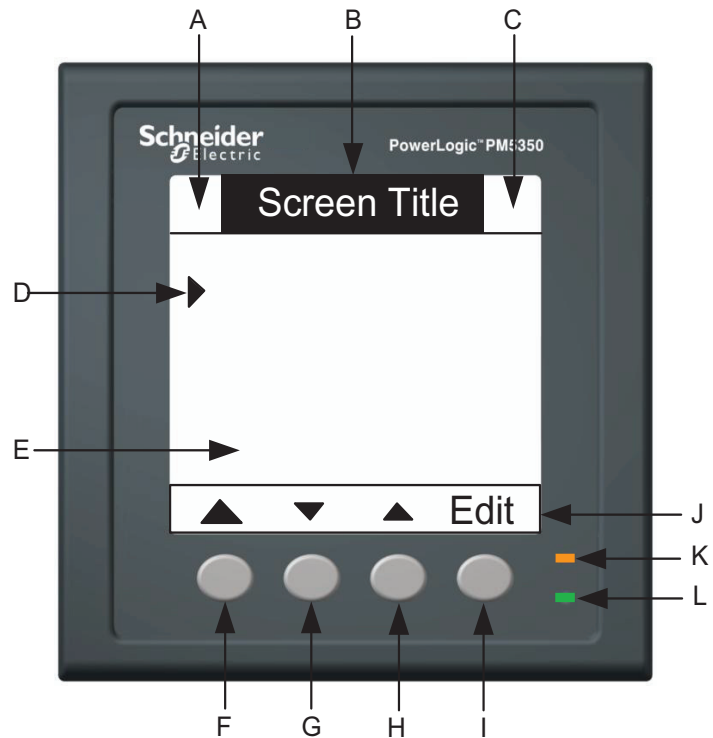

- A. Icon 1—Wrench Icon (Maintenance) or Heartbeat Icon
- B. Screen Title
- C. Icon 2—Alarm Icon
- D. Cursor
- E. Data Area
- F. Button 1
- G. Button 2
- H. Button 3
- I. Button 4
- J. Menu Area
- K. Energy/Alarm LED (orange)
- L. Heartbeat/Communication LED (green)

## How the Buttons Work

The buttons select menu items, display more menu items in a menu list, and return to previous menus. A menu item appears over one of the four buttons. Pressing a button selects the menu item and displays the menu item’s screen. To return to the previous menu level, press the button below ▲. To cycle through the menu items in a menu list, press the button below ►. Table 3–1 describes the button symbols.

**Table 3–1: Button Symbols**

Navigation	
▲	Return to the previous screen. For setup screens: <ul style="list-style-type: none"> <li>• If setup changes are made, a confirmation screen is displayed.</li> <li>• If editing a value, exits edit mode and restores previous value.</li> </ul>
▼	Move cursor down.
▲	Move cursor up.
◀	Move the cursor one character to the left.
▶	Move cursor one character to the right.
X	Indicates the item is selected.
+	Increment active character; toggle list selection On.
-	Decrement active character; toggle list selection Off.
Edit	Select parameter or item to edit.
Select	Select/deselect item for association.
OK	Enter change to a parameter.
Yes	Accept.
No	Reject.
Ack	Acknowledge alarms.
Reset	Reset selected item.
Detail	Details of selected item.
Next	Advance to next circuit reading (only available in Multi Circuit circuit mode.)

- To differentiate between menu items and parameters, menu items are placed in brackets. For example, “[Phase]” denotes a phase menu item, and “Phase” denotes a phase parameter.
- Each time you read “press” in this manual, press and release the appropriate button beneath a menu item. For example, if you are asked to “Press [Phase],” you would press and release the button below the phase menu item.

### Changing Values

In this document, “item” refers to a feature such as an alarm, and “parameter” refers to an attribute of an item such as a pickup setpoint.

When you enter a setup screen, the cursor points to the first setup item or parameter on the screen. Press ▼ and ▲ to move to the item or parameter you wish to edit. Press [Edit] to select a parameter. The value to be edited is displayed in the edit field, with the active digit of the setup value shown in reverse video.

To change a text value:

- Press ► to enter the selected value for the active digit and move to the next digit to the right. At the maximum number of digits, the ► takes you back to the first digit.
- Press + to increment and - to decrement the active digit through the numerals 0-9, the letters A-Z, the "." or any other possible selections.

To change a numerical value:

- Press ◀ to enter the selected value for the active digit and move to the next digit to the left. At the maximum number of digits, the ◀ takes you back to the first digit.
- Press + to increment the active digit through the numerals 0-9, and ".", "+", and "-".

To select a value from a list:

- Press + to scroll up and - to scroll down through the list of available selections.
- Press [OK] to enter the selected value.

## Icons

The icons flash to indicate the power meter LCD is operational.

- **Wrench Icon**—The power meter requires maintenance.
- **Heartbeat Icon**—The power meter LCD is operational.
- **Alarm Icon**—See "About Alarms" on page 39 and "Alarm Priorities" on page 41.

## LEDs

There are two LEDs on the power meter display, the energy/alarm LED and the heartbeat/communication LED.

### Energy/Alarm LED

Configure the energy/alarm LED in the following three ways:

- **Energy Indicator**—Flashes at a rate proportional to the amount of energy consumed, allows the accuracy of the power meter to be verified.
- **Alarm**—Flashes as long as there are any active high priority alarms. The LED blinks until the alarm is acknowledged.
- **Off**—Default

**NOTE:** See "Setting Up the Energy/Alarm LED" on page 60 for more information.

### Heartbeat/Communication LED

The heartbeat/communication LED flashes at a steady rate during normal operation and at a variable rate when communications is active.

**NOTE:** See "Heartbeat/Communication LED" on page 63 for more information.

When you complete setup for the selected feature, press ▲ to return to the previous screen. If any setup changes are made, a confirmation screen appears with the choice to

save the changes or cancel. Select [Yes], to save changes and return to the previous screen. Select [No], to cancel the changes and return to the previous screen.

**Figure 3–2: Confirmation screen**



If any setup parameters are invalid, the “Invalid Parameter(s)” screen displays (see Figure 3–3). Press ▲ to return to the previous setup screen.

**Figure 3–3: Invalid Parameter(s) screen**





# Menu Overview

Menu items are displayed below the horizontal line at the bottom of the screen. Figure 3–4 below shows the menu items of the power meter menu hierarchy in Normal circuit mode. Selecting a Level 1 menu item takes you to the next screen level containing the Level 2 menu items. Some Level 2 items have Level 3 items. The navigation buttons work consistently across all menu levels. Press **▶** to scroll through all menu items on a level.

**Figure 3–4: Menu Tree**

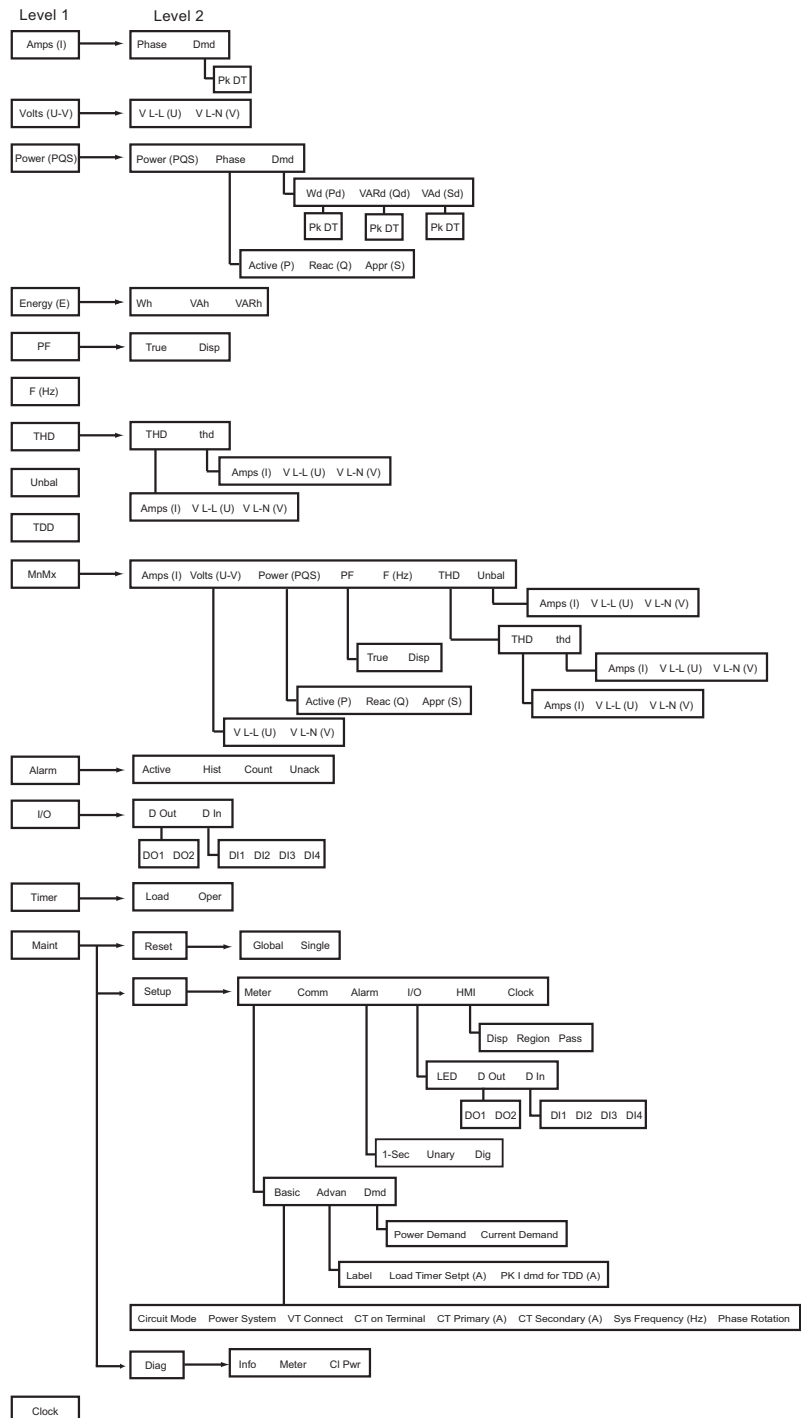

## Setting Up the Power Meter

The power meter ships with many default values already set up. To change values, navigate to the appropriate screen and enter new values. Use the instructions in the following sections to change values. New values are automatically saved when you exit the screen and accept the confirmation request.

### Power Meter Basic Setup

To begin power meter basic setup:

1. Scroll to [Maint] in the menu list.
2. Press [Maint].
3. Press [Setup].
4. Enter your setup password.

**NOTE:** The default password is 0000. See “Setting Up Passwords” on page 24 for information on changing passwords.

5. Press [Meter].
6. Press [Basic]. The Basic Setup screen appears.

Use the directions in the following sections to set up basic power meter values.

**NOTE:** If you make changes to the basic power meter setup, all alarms disable to prevent undesired alarm operation. Confirm alarm configuration and enable the required alarms.

### Setting Up the Power System

The power meter has two circuit modes: **Normal** (default) and **Multi Circuit**. See “Supported Power System Configurations” on page 11 for more information on power systems in Normal mode. See Appendix E on page 77 for information on multi circuit power system configurations.

To set up the power system:

1. Press [Edit] to select Power System.
2. Press + and - to scroll through the list of supported power system configurations.
3. Press [OK] to select the power system configuration to be metered.



### Supported Power System Configurations

The power meter supports several power system configurations. See Figure 3–5 and Figure 3–6, and Table 3–2, Table 3–3, and Table 3–4 for details.

**NOTE:** There are additional supported power system configurations in Multi Circuit circuit mode. See Appendix E on page 77 for information on multi circuit power system configurations.

Figure 3–5: Single-Phase Power System Configurations

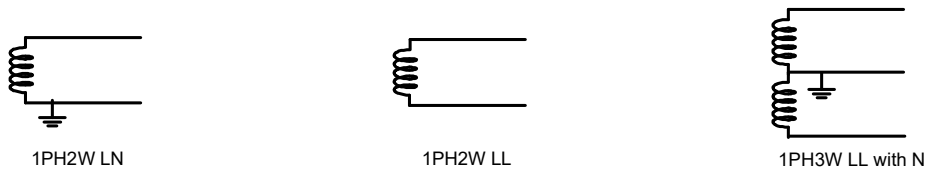

Table 3–2: Single-Phase

Power System Configuration	Number of Wires	CTs		Voltage Connections		
		Qty.	Meter Terminal	Qty.	Meter Terminal	Type
<b>Single-Phase Wiring</b>						
1PH2W LN	2	1	I1	2	V1, Vn	L-N
1PH2W LL	2	1	I1	2	V1, V2	L-L
1PH3W LL with N	3	2	I1, I2	3	V1, V2, Vn	L-L with N

**NOTE:** For 1 CT and 2 CT systems, you must configure the power meter for the phase on which the CT is installed.

Figure 3–6: Three-Phase Power System Configurations

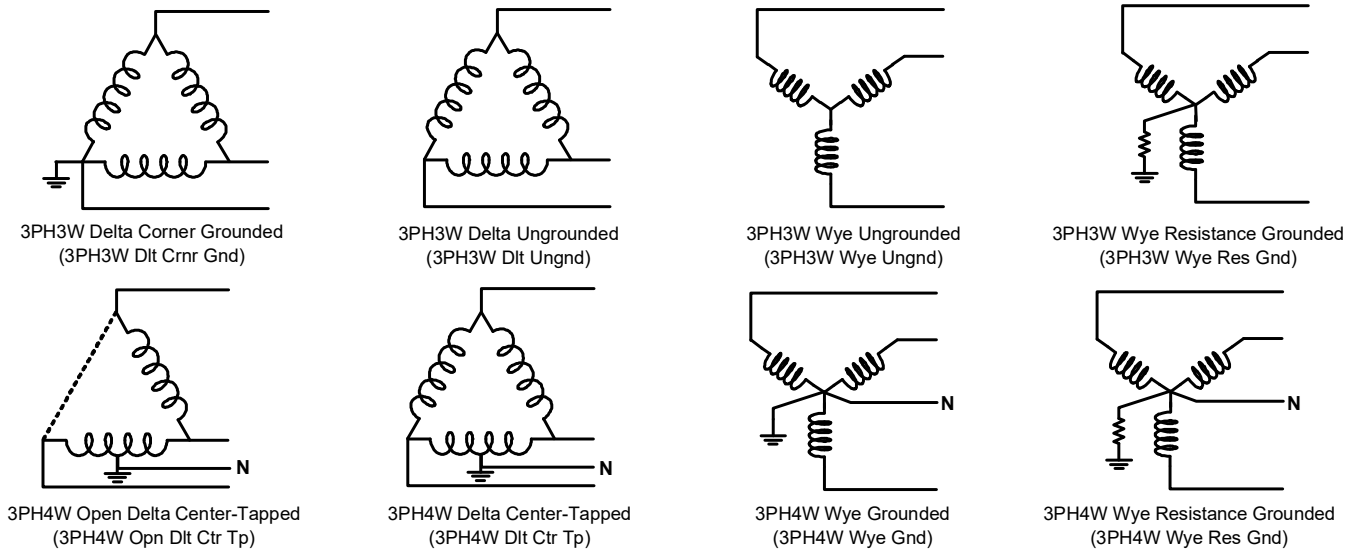

Table 3–3: Three-Phase Direct Connect

Power System Configuration	Number of Wires	CTs		Voltage Connections		
		Qty.	Meter Terminal	Qty.	Meter Terminal	Type
<b>Three-Phase Wiring</b>						
3PH3W Dlt Cmr Gnd 3PH3WDlt Ungnd 3PH3W Wye Ungnd 3PH3W Wye Res Gnd	3	2	I1, I3	3	V1, V2, V3	Delta
3PH3W Dlt Cmr Gnd 3PH3WDlt Ungnd 3PH3W Wye Ungnd 3PH3W Wye Res Gnd	3	3	I1, I2, I3	3	V1, V2, V3	Delta
3PH3W Dlt Cmr Gnd 3PH3WDlt Ungnd 3PH3W Wye Ungnd 3PH3W Wye Res Gnd	3	1	I1	3	V1, V2, V3	Delta (Balanced)
<b>NOTE:</b> For 1 CT and 2 CT systems, you must configure the power meter for the phase on which the CT is installed.						
Power System Configuration	Number of Wires	CTs		Voltage Connections		
		Qty.	Meter Terminal	Qty.	Meter Terminal	Type
<b>Three-Phase Wiring</b>						
3PH4W Opn Dlt Ctr Tp 3PH4W Dlt Ctr Tp 3PH4W Wye Gnd 3PH4W Wye Res Gnd	4	3	I1, I2, I3	4	V1, V2, V3, Vn	Delta
3PH4W Opn Dlt Ctr Tp 3PH4W Dlt Ctr Tp 3PH4W Wye Gnd 3PH4W Wye Res Gnd	4	3	I1, I2, I3	4	V1, V2, V3, Vn	Wye
3PH4W Opn Dlt Ctr Tp 3PH4W Dlt Ctr Tp 3PH4W Wye Gnd 3PH4W Wye Res Gnd	4	1	I1	4	V1, V2, V3, Vn	Wye (Balanced)
<b>NOTE:</b> For 1 CT and 2 CT systems, you must configure the power meter for the phase on which the CT is installed.						

**Table 3–4: Three-Phase (with VTs)**

Power System Configuration	Number of Wires	CTs		Voltage Connections		
		Qty.	Meter Terminal	Qty.	Meter Terminal	Type
<b>Three-Phase Wiring</b>						
3PH3W Dlt Cmr Gnd 3PH3WDlt Ungnd 3PH3W Wye Ungnd 3PH3W Wye Res Gnd	3	2	I1, I3	2	V1, V3 (V2 to Ground)	Delta
		3	I1, I2, I3	2	V1, V3 (V2 to Ground)	Delta
3PH3W Dlt Cmr Gnd 3PH3WDlt Ungnd 3PH3W Wye Ungnd 3PH3W Wye Res Gnd	3	1	I1	2	V1, V3 (V2 to Ground)	Delta (Balanced)
3PH4W Opn Dlt Ctr Tp 3PH4W Dlt Ctr Tp 3PH4W Wye Gnd 3PH4W Wye Res Gnd	4	3	I1, I2, I3	3	V1, V2, V3 (Vn to Ground)	Wye
		3	I1, I2, I3	2	V1, V3 (Vn to Ground)	Wye
		2	I1, I2, I3	3	V1, V2, V3 (Vn to Ground)	Wye
3PH4W Opn Dlt Ctr Tp 3PH4W Dlt Ctr Tp 3PH4W Wye Gnd 3PH4W Wye Res Gnd	4	1	I1	3	V1, V2, V3 (Vn to Ground)	Wye (Balanced)

**NOTE:** For 1 CT and 2 CT systems, you must configure the power meter for the phase on which the CT is installed.

### Overcurrent Protection

Clearly label the device’s disconnect circuit mechanism and install it within easy reach of the operator.

**NOTE:** The disconnect circuit breaker or fusing must be rated for the available short circuit current at the connection points.

**Table 3–1: Fuse Recommendations**

Control Power Source	Source Voltage (Vs)	Fuse	Fuse Amperage
CPT	$V_s \leq 125 \text{ Vac}$	FNM or MDL	250 mA
CPT	$125 < V_s \leq 240 \text{ Vac}$	FNQ or FNQ-R	250 mA
CPT	$240 < V_s \leq 277 \text{ Vac}$	FNQ or FNQ-R	250 mA
Line Voltage	$V_s \leq 240 \text{ Vac}$	FNQ-R	250 mA
Line Voltage	$V_s > 240 \text{ Vac}$	FNQ-R	250 mA
DC	$V_s \leq 300 \text{ Vdc}$	LP-CC	500 mA

For selecting fuses and circuit breakers other than those listed above, use the following criteria:

- Select overcurrent protection rated as listed above.
- Select current interrupt capacity based on the installation category and fault current capability.
- Select overcurrent protection with a time delay.
- The voltage rating should be based on the input voltage applied.
- If a 250 mA fuse is not available with the required fault current capability, use a fuse rated at a maximum of 500 mA.
- Fuse protection can be substituted with molded-case circuit breaker 0.5A/4-Pole.

## Setting Up Voltage Connection and CT Options

The options available for voltage connections (VT Connect) and the number of CTs that can be selected (CT on Terminal) are based on the power system selected in “Setting Up the Power System” on page 10. The CT Primary and Secondary are set in Amps (A).

To set up voltage connections and CTs:

1. Press ▼ to select VT Connect, then press [Edit].
  2. Press + and - to scroll through the VT Connect options.
  3. Press [OK] to select the VT Connect. If you choose Direct Con, skip to step 8.
  4. Press ▼ to select VT Primary (V), then press [Edit].
  5. Press + and - to scroll through the options.
  6. Press [OK] to select VT Primary (V).
  7. Press ▼ to select VT Secondary (V), then follow steps 4 to 6 to select VT Secondary.
  8. Press ▼ to select CT on Terminal, then press [Edit].
  9. Press + and - to scroll through the terminal options.
  10. Press [OK] to enter the terminal the CT is on.
  11. Press ▼ to select CT Primary (A), then press [Edit].
  12. Press + to increment the active digit through the numerals 0-9.
  13. Press ◀ to enter the selected value for the active digit and move to the next digit to the left.
  14. Continue until all values are selected, then press [OK] to enter the CT Primary.
  15. Press ▼ to select CT Secondary (A), then press [Edit].
  16. Press + and - to scroll through a list of CT Secondary options.
- NOTE:** CT Secondary options are 5A or 1A. See “Specifications” on page 65 for accuracy level.
17. Press [OK] to select the CT Secondary.

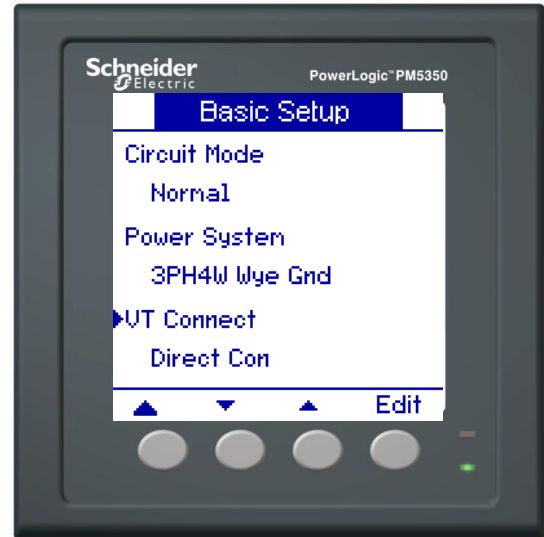

## Setting Up the System Frequency

The system frequency is limited to 50 Hz or 60 Hz.

To set up the system frequency:

1. Press ▼ to select System Frequency, then press [Edit].
2. Press + and - to scroll between 50 and 60 Hz.
3. Press [OK] to select the system frequency.



## Setting Up the Phase Rotation

The phase rotation is limited to ABC or CBA.

To set up the phase rotation:

1. Press ▼ to select Phase Rotation, then press [Edit].
2. Press + and - to scroll between ABC and CBA.
3. Press [OK] to select the phase rotation.

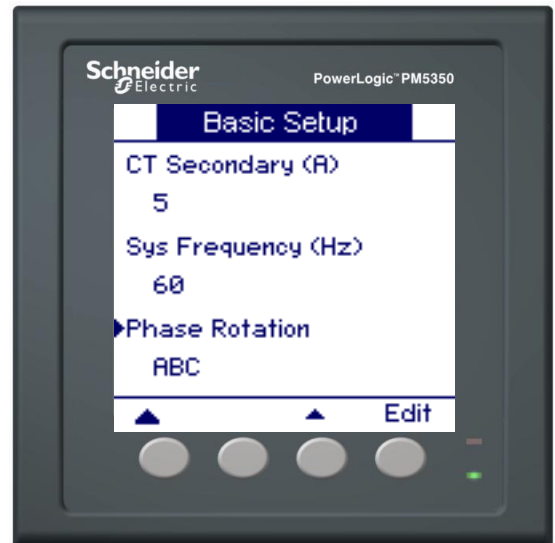

## Power Meter Advanced Setup

To begin power meter advanced setup:

1. Scroll to [Maint] in the menu list.
2. Press [Maint].
3. Press [Setup].
4. Enter your setup password.

**NOTE:** The default password is 0000. See “Setting Up Passwords” on page 24 for information on changing passwords.

5. Press [Meter].
6. Press [Advan].

Use the directions in the following sections to set up power meter advanced values.

### Setting Up the Load Timer Setpoint

There are two typical uses for the load timer setpoint:

- Select a relatively low setpoint. The timer increments when the load being metered is running. This could be useful in recording machine run time for a preventive maintenance program.
- Select a setpoint that is equal to the rating of the power system conductors. The timer increments and records how long the conductors were overloaded. This could be used to help determine if a circuit has the capacity to add additional load or if loads should be moved to another circuit.

The load timer setpoint is set in Amps (A).

To set up the load timer setpoint:

1. Press ▼ to select Load Timer Setpoint, then press [Edit].
2. Press + to increment the active digit through the numerals 0-9.
3. Press ◀ to enter the selected value for the active digit and move to the next digit to the left.
4. Continue until all values are selected, then press [OK] to set the load timer setpoint.



## Setting Up the Peak Current Demand Over Last Year

The peak current demand over last year calculates Total Demand Distortion (TDD) in amperes. See the TDD discussion in “Power Analysis Values” on page 37 for more information. Enter 0 if you want the power meter to use metered current peak demand for this calculation.

The peak current demand is set in Amps (A).

To set up the peak current demand over last year:

1. Press ▼ to select Pk Current Dmd for TDD, then press [Edit].
2. Press + to increment the active digit through the numerals 0-9.
3. Press ◀ to enter the selected value for the active digit and move to the next digit to the left.
4. Continue until all values are selected, then press [OK] to enter the peak current demand over last year.

## Power Meter Demand Setup

To begin power meter demand setup:

1. Scroll to [Maint] in the menu list.
2. Press [Maint].
3. Press [Setup].
4. Enter your setup password.  
**NOTE:** The default password is 0000. See “Setting Up Passwords” on page 24 for information on changing passwords.
5. Press [Meter].
6. Press [Dmd].

Use the directions in the following sections to set up power meter demand values.

## Setting Up Power and Current Demand

To set up the power or current, demand:

1. Press ▼ and ▲ to scroll between Power and Current Demand.
2. Press [Edit] to select a demand.
3. Press [Edit] to select Method.
4. Press + and - to scroll through a list of supported demand methods.
5. Press [OK] to select the demand method.

**NOTE:** If you select Input Sync Block or Rolling Block, see “Select the Digital Input” on page 19.

6. Press ▼ to select Interval, then press [Edit].
7. Press + to increment the active digit through the numerals 0-9.
8. Press ◀ to enter the selected number for the active digit and move to the next digit to the left.
9. Continue until all values are selected, then press [OK] to enter the interval.
10. If you selected a Rolling Block method (Timed, Input Sync, Cmd Sync), press ▼ to select Subinterval, then press [Edit]. Otherwise, proceed to Step 13.
11. Press + to increment the active digit through the numerals 0-9.  
**NOTE:** The subinterval duration must be evenly divisible into the demand interval duration.
12. Continue until all values are selected, then press [OK] to enter the subinterval.



## Setting Up Power and Current Demand (continued)

13. Press ▼ to select Select Dig Output, then press [Edit].
14. Press + and - to scroll through the digital outputs.
15. Press [OK] to select the digital output to be associated with the demand system.
16. Press ▲ to return to the previous screen.

**NOTE:** If existing associations will be lost by making the new selection, a confirmation screen appears.

- Press [Yes] to accept the changes and return to the previous screen.
- Press [No] to keep the existing configuration and return to the previous screen.



## Select the Digital Input

If you select Input Sync Block or Input Sync Rolling Block as the demand method, select the digital input to be associated with the demand system.

When the digital input is energized, the demand interval will trigger. For a valid demand interval, the digital input must be energized within +/-5 seconds of the set interval.

To select the digital input:

1. Press ▼ to select Select Dig Input, then press [Edit].
2. Press + and - to scroll through the digital inputs.
3. Press [OK] to select the digital input to be associated with the demand system.
4. Press ▲ to return to the previous screen.

**NOTE:** If existing associations will be lost by making the new selection, a confirmation screen appears.

- Press [Yes] to accept the changes and return to the previous screen.
- Press [No] to keep the existing configuration and return to the previous screen.



## Power Meter Communication Setup

To begin power meter communication setup:

1. Scroll to [Maint] in the menu list.
2. Press [Maint].
3. Press [Setup].
4. Enter your setup password.

**NOTE:** The default password is 0000. See “Setting Up Passwords” on page 24 for information on changing passwords.

5. Press [Comm]. The Communication Setup screen appears.

Use the directions in the following sections to set up power meter communications values.

### Setting Up Communications

To set up communications:

1. Press ▼ to select Protocol, then press [Edit].
2. Press + and - to scroll through the protocol options.
3. Press [OK] to set the protocol.
4. Press ▼ to select Address, then press [Edit].
5. Press + to increment the active digit through the numerals 0-9.
6. Press ◀ to enter the selected value for the active digit and move to the next digit to the left.
7. Continue until all values are selected, then press [OK] to set the address.
8. Press ▼ to select Baud Rate, then press [Edit].
9. Press + and - to scroll through the Baud rate options.
10. Press [OK] to set the Baud rate.
11. Press ▼ to select Parity, then press [Edit].
12. Press + and - to scroll through the parity options.
13. Press [OK] to set the parity.

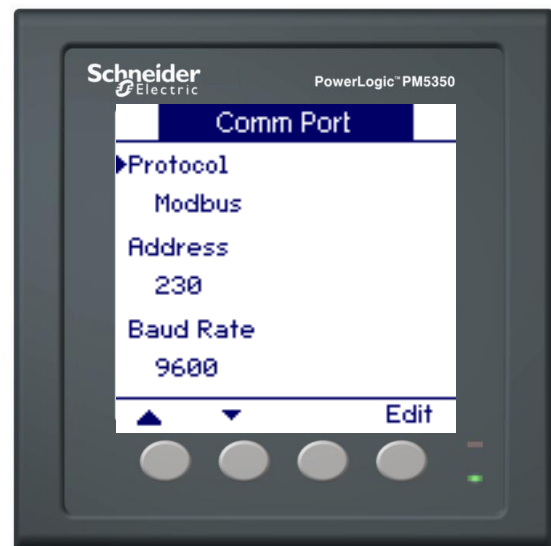

### Setting Up Alarms

See “Alarms” on page 39 for information on setting up alarms.

## Setting Up I/O

See “Input/Output Capabilities” on page 51 for information on setting up I/O.

## Power Meter HMI Setup

To begin power meter HMI setup:

1. Scroll to [Maint] in the menu list.
2. Press [Maint].
3. Press [Setup].
4. Enter your setup password.

**NOTE:** The default password is 0000. See “Setting Up Passwords” on page 24 for information on changing passwords.

5. Press [HMI]. The HMI Setup screen appears.

Use the directions in the following sections to set up power meter HMI values.

### Setting Up the Display

To set up the display:

1. Press [Disp]. The Display screen appears.
2. Press [Edit] to select Contrast.
3. Press + to increment the active digit through the numerals 0-9.

**NOTE:** The contrast values range between 1 and 9.

4. Press [OK] to set the contrast.
5. Press ▼ to select Backlight Timeout (min), then press [Edit].
6. Press + to increment the active digit through the numerals 0-9.  
**NOTE:** The backlight timeout values range between 0 and 60 minutes. 0 disables the timeout.
7. Press ◀ to enter the selected value for the active digit and move to the next digit to the left.
8. Continue until all values are selected, then press [OK] to set the backlight timeout.

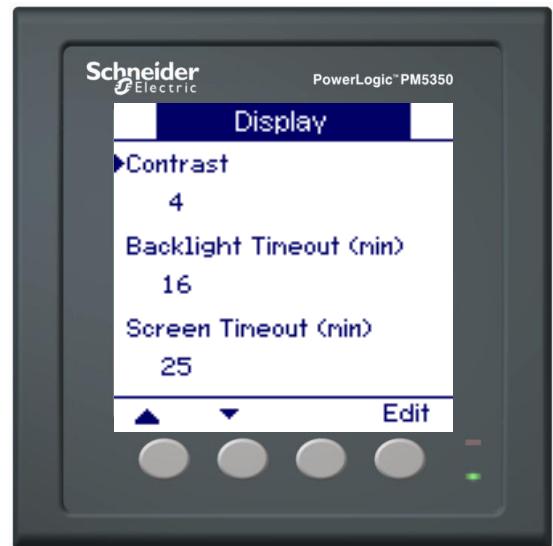

## Setting Up the Display (continued)

9. Press ▼ to select Screen Timeout (min), then press [Edit].
10. Press + to increment the active digit through the numerals 0-9.  
**NOTE:** The screen timeout values range between 0 and 60 minutes. 0 disables the timeout.
11. Press ◀ to enter the selected value for the active digit and move to the next digit to the left.
12. Continue until all values are selected, then press [OK] to set the screen timeout.
13. Press ▲ to return to the previous screen.  
**NOTE:** If existing associations will be lost by making the new selection, a confirmation screen appears.
  - Press [Yes] to accept the changes and return to the previous screen.
  - Press [No] to keep the existing configuration and return to the previous screen.

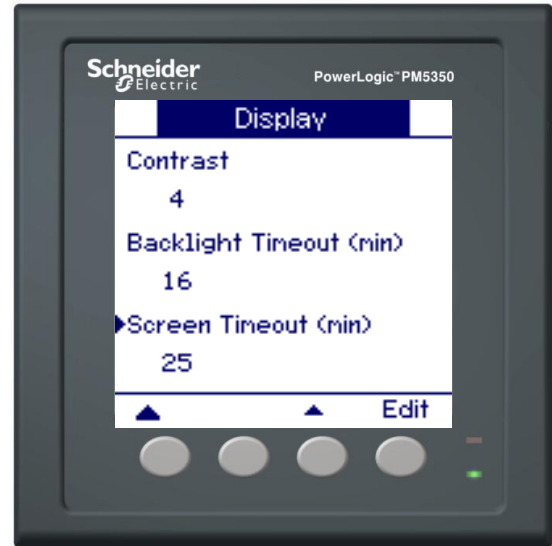

## Setting Up Regional Settings

To set up regional settings:

1. Press [Region]. The Regional Settings screen appears.
2. Press [Edit] to select Language.
3. Press + and - to scroll through the language options.
4. Press [OK] to set the language.

**NOTE:** Models with communications support the download of language files with additional languages to the power meter. All languages available on the power meter are listed. See "Downloading Firmware" on page 62 for more information.

5. Press ▼ to select Date Format, then press [Edit].
6. Press + and - to scroll through the date format options.
7. Press [OK] to set the date format.
8. Press ▼ to select Time Format, then press [Edit].
9. Press + and - to scroll through the time format options.
10. Press [OK] to set the time format.
11. Press ▼ to select HMI Mode, then press [Edit].
12. Press + and - to scroll through the HMI mode options.
13. Press [OK] to set the HMI mode.
14. Press ▲ to return to the previous screen.

**NOTE:** If existing associations will be lost by making the new selection, a confirmation screen appears.

- Press [Yes] to accept the changes and return to the previous screen.
- Press [No] to keep the existing configuration and return to the previous screen.



## Setting Up Passwords

The passwords for HMI access to setup and resets are configurable. Passwords must use four numeric characters. The characters are from the US ASCII character set and are not translated or affected by language selection.

To set up a password:

1. Press ▼ and ▲ to scroll through the passwords in the Passwords screen.
2. Press [Edit] to select a password.
3. Press + to increment the active digit through the numerals 0-9.
4. Press ◀ to enter the selected value for the active digit and move to the next digit to the left.
5. Continue until all values are selected, then press [OK] to set the password.



## Power Meter Clock Setup

To begin power meter clock setup:

1. Scroll to [Maint] in the menu list.
2. Press [Maint].
3. Press [Setup].
4. Enter your setup password.

**NOTE:** The default password is 0000. See “Setting Up Passwords” on page 24 for information on changing passwords.

5. Press [Clock]. The Clock setup screen appears.

Use the directions in the following sections to set up power meter clock values.



## Setting Up the Clock

The power meter stores all date and time stamps in GMT. If “Local” meter time is selected, the GMT offset converts the GMT values to local date and time values for display on the HMI. There is also an option to display the GMT values on the HMI.

To set up the clock:

1. Press [Edit] to select Date.
2. Press + to increment the active digit for the first character of the date.
3. Press ◀ to enter the selected character and move to the character to the left.
4. Continue until all values are selected, then press [OK] to set the date.
5. Press ▼ and follow Steps 2 to 6 to set the Time.
6. Press ▼ to select Meter Time, then press [Edit].
7. Press + and - to scroll through the meter time options.
8. Press [OK] to set the meter time.

## Reset the Power Meter

To begin power meter reset setup:

1. Scroll to [Maint] in the menu list.
2. Press [Maint].
3. Press [Reset]. The Resets screen appears.

Meter values can be re-initialized using the reset function. Resets are grouped into global resets and single resets. Use the directions in the following sections to set up power meter reset values.

## Global Resets

Global resets include power meter reinitialization, as well as resets of all values for the following items:

- Energies
- Demands
- Min/Max Values
- Alarm Logs and Counters
- I/O Counters and Timers

To reinitialize the power meter:

1. Press [Select] to select Global Resets.
2. Press [Reset] to select Meter Initialization.
3. Enter the Energy Password, then press [OK].
4. A confirmation screen appears.
  - Press [Yes] to reset the power meter.
  - Press [No] to return to the previous screen.

To reset all values for a selected item:

1. Press [Select] to select Global Resets.
2. Press ▼ and ▲ to scroll to the item you want to reset.
3. Press [Reset].  
**NOTE:** If you selected energies, demands, or min/max, a password is required. Enter the reset password for the selected item.
4. Press [OK].
5. A confirmation screen appears.
  - Press [Yes] to reset all values.
  - Press [No] to return to the previous screen.



## Single Resets

Single resets allow you to reset specific items individually. Use the single reset option to reset the following values:

- Energy
- Demand
- Alarms
- Digital Inputs
- Digital Outputs
- Active Load Timer

To reset a value for the selected item:

1. Press ▼ to select Single Resets, then press [Select].
2. Press ▼ and ▲ to scroll to the item you want to reset.
3. Press [Select].  
**NOTE:** If you selected energy or demand, a password is required. Enter the reset password for the selected item.
4. In the item Reset screen, press ▼ and ▲ to select the specific value you wish to reset.  
**NOTE:** The example displays a demand reset with Demand selected for reset.
5. Press [Reset] to reset the selected value.
6. A confirmation screen appears.
  - Press [Yes] to reset the selected value.
  - Press [No] to return to the previous screen.

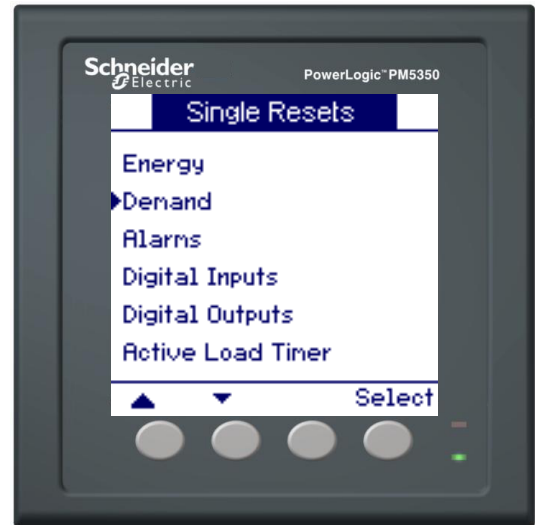



## Chapter 4—Metering

### Power Meter Characteristics

The power meter measures currents and voltages and reports in real time the rms values for all three phases and neutral. In addition, the power meter calculates power factor, real power, reactive power, and more.

The PM5350 is not for use on Direct Current (DC) circuits. The power meter will incorrectly read 0 volts.

Table 4–1 lists metering characteristics of the power meter.

**Table 4–1: Power Meter Characteristics**

<b>Instantaneous rms Values</b>	
Current	Per phase, neutral or ground, average of 3 phases
Voltage	Average of 3 phases, L-L and L-N
Frequency	45 to 70 Hz
Active power	Total and per phase (signed)
Reactive power	Total and per phase (signed)
Apparent power	Total and per phase
True Power Factor	Total and per phase 0.000 to 1 (signed, four quadrant)
Displacement Power Factor	Total and per phase 0.000 to 1 (signed, four quadrant)
<b>Energy Values (Delivered, Received, Del+Rec, Del-Rec)</b>	
Active energy	0 to $9.2 \times 10^{18}$ Wh
Reactive energy	0 to $9.2 \times 10^{18}$ VARh
Apparent energy	0 to $9.2 \times 10^{18}$ VAh
<b>Demand Values</b>	
Current	Average
Active, reactive, apparent power	Total
<b>Maximum Demand Values</b>	
Maximum current	Average
Maximum active power	Total
Maximum reactive power	Total
Maximum apparent power	Total
<b>Power-Quality Values</b>	
Total harmonic distortion (THD and thd)	Current and voltage (L-L and L-N)
Total demand distortion (TDD)	
<b>Reset</b>	
Maximum demand current and power (password protected)	
Energy values (HMI password protected)	
Minimum and maximum values (password protected)	
Active load timer	
I/O Counters and timers	
<b>Visualization Modes</b>	
IEC and IEEE	All calculations are the same under both visualization modes.
<b>Minimum and Maximum Values</b>	
Real power per phase and total	
Apparent power per phase and total	
Reactive power per phase and total	
PF (power factor) true and displacement, per phase and total	
Current per phase and average	
Voltage (L-L and L-N) per phase and average	
THD and thd current per phase	
THD and thd voltage (L-L and L-N)	

**Table 4–1: Power Meter Characteristics** (continued)

Local or Remote Setup	
Distribution system Type	3-phase 3- or 4-wire with 1, 2, or 3 CTs, single-phase 2- or 3-wire with 1 or 2 CTs
Current transformers rating	Primary 5 to 32,767 A Secondary 5 A, 1 A
Voltage transformers rating	Primary 1,000,000 V max Secondary 100 V, 110 V, 115 V, 120 V
Demand currents calculation method	1 to 60 minutes
Demand power calculation method	1 to 60 minutes

## MODBUS RS-485

Functions	
RS-485 link	2-wire
Communication protocol	MODBUS RTU, MODBUS ASCII, JBUS
Settings	
Communication address	1 to 247 (255 for JBUS)
Baud rate (communication speed)	9600, 19200, 38400 baud
Parity	none, even, odd

## Digital Outputs

Digital Outputs	
Modes: External, Alarm, Demand Sync	2 Electromechanical relays

## Digital Inputs

Digital Inputs	
Modes: Normal, Demand Sync	4 digital inputs

## Min/Max Values for Real-Time Readings

When any one-second real-time reading reaches its highest or lowest value, the power meter saves the values in its nonvolatile memory. These values are called the minimum and maximum (min/max) values.

From the power meter display you can:

- View all min/max values since the last reset and the reset date and time. See Table 4–1 for a list of the minimum and maximum values stored in the power meter.
- Reset min/max values. See “Reset the Power Meter” on page 25.

All running min/max values are arithmetic minimum and maximum values. For example, the minimum phase A–B voltage is the lowest value in the range 0 to 1200 kV that has occurred since the min/max values were last reset.

## Power Factor Min/Max Conventions

The Power Factor (PF) values are encoded into four quadrant floating point register values. These values fall between the minimum and maximum on a continuous scale for all real-time readings:  $-2 < PF \leq 2$ . The minimum value represents the measurement closest to -2 and the maximum value is the measurement closest to 2 on the scale.

**NOTE:** See “Power Factor Register Format” on page 71 for information on using register values to determine power factor values.

Figure 4–1 below shows two examples of min/max values. Note that the minimum power factor need not be leading, and the maximum power factor need not be lagging.

In Example A, the customer is metering a substation that provides power to the utility (Energy Received). The minimum register value is -1.67 and the maximum is -0.9 with power factor values ranging from 0.33 (leading) to 0.9 (lagging) respectively.

In Example B, the customer is being supplied power by the utility (Energy Delivered). The minimum register value is 0.8 and the maximum is 1.134 with power factor values ranging from 0.8 (lagging) to 0.866 (leading) respectively.

**Figure 4–1: Min/Max Examples**

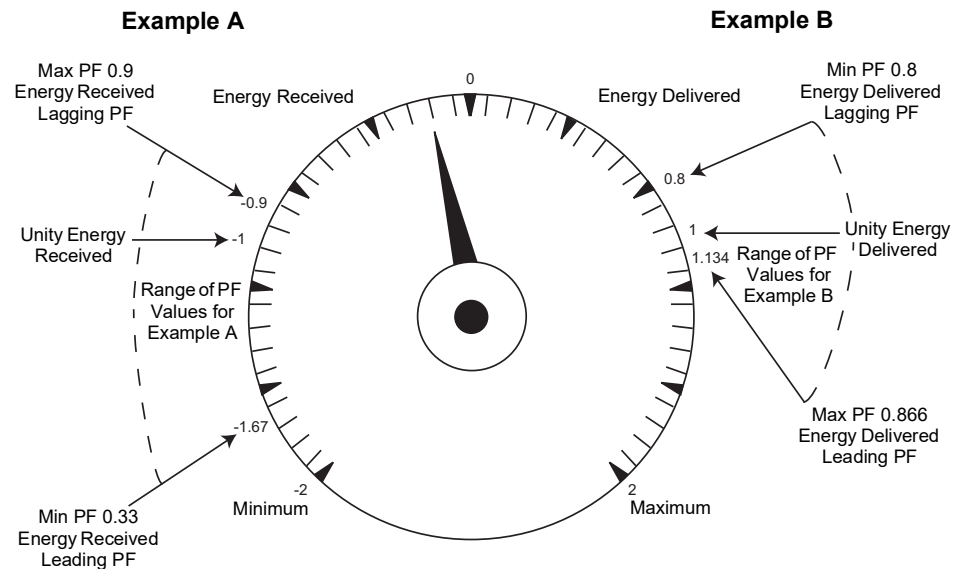

## Demand Readings

The power meter provides a variety of demand readings. Table 4–2 lists the available demand readings and their reportable ranges.

**Table 4–2: Demand Readings**

Demand Readings
<b>Demand Current, Average</b>
Last Complete Interval
Present Incomplete Interval
Predicted
Peak
<b>Demand Real Power, 3Ø Total</b>
Last Complete Interval
Present Incomplete Interval
Predicted
Peak
<b>Demand Reactive Power, 3Ø Total</b>
Last Complete Interval
Present Incomplete Interval
Predicted
Peak
<b>Demand Apparent Power, 3Ø Total</b>
Last Complete Interval
Present Incomplete Interval
Predicted
Peak

## Demand Calculation Methods

Demand power is the energy accumulated during a specified period divided by the length of that period. How the power meter performs this calculation depends on the method you select. To be compatible with electric utility billing practices, the power meter provides the following types of demand power calculations:

- Block Interval Demand
- Synchronized Demand
- Thermal Demand

The default demand calculation is set to a fixed block with a 15 minute interval.

### Block Interval Demand

In the block interval demand method, you select a “block” of time that the power meter uses for the demand calculation. You choose how the power meter handles that block of time (interval). Three different modes are possible:

- **Sliding Block.** Select an interval from 1 to 60 minutes (in 1-minute increments). For demand intervals less than 15 minutes, the value is updated every 15 seconds. For demand intervals 15 minutes and greater, the demand value is updated every 60 seconds. The power meter displays the demand value for the last completed interval.
- **Fixed Block.** Select an interval from 1 to 60 minutes (in 1-minute increments). The power meter calculates and updates the demand at the end of each interval.



- **Rolling Block.** Select an interval and a subinterval. The subinterval must divide evenly into the interval. For example, you might set three 5-minute subintervals for a 15-minute interval. Demand for each completed interval is updated at each subinterval. The power meter displays the demand value for the last completed interval.

Figure 4–2 illustrates the three ways to calculate demand power using the block method. For illustration purposes, the interval is set to 15 minutes.

**Figure 4–2: Block Interval Demand Examples**

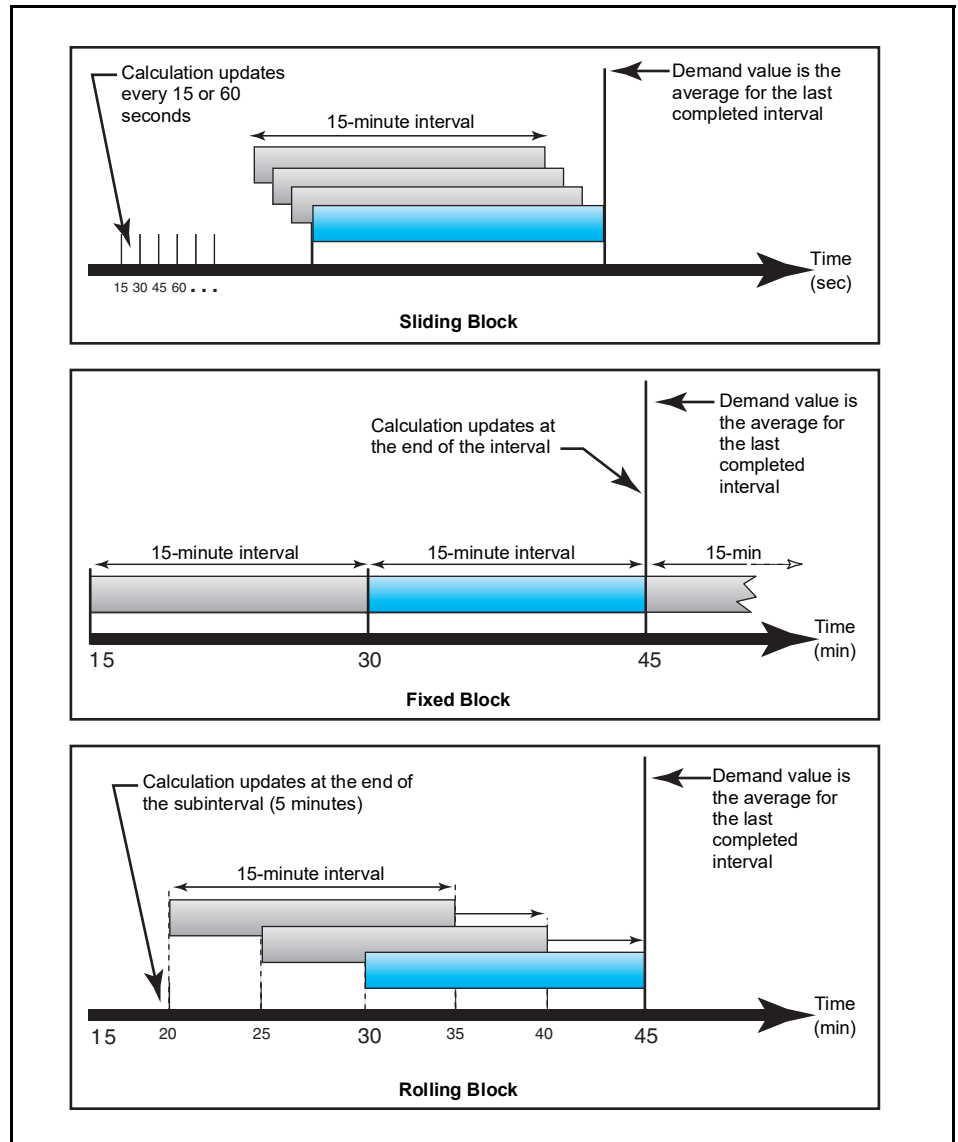

## Synchronized Demand

The demand calculations can be synchronized by accepting an external pulse input, a command sent over communications.

- **Input Synchronized Demand.** You can set up the power meter to accept a demand synch pulse from an external source. When the power meter sees a pulse, it starts a new demand interval and calculates the demand for the preceding interval. The power meter then uses the same time interval as the other meter for each demand calculation. Figure 4–3 illustrates this point. You can use the standard digital input installed on the meter to receive the synch pulse. When setting up this type of demand, you select whether it will be input-synchronized block or input-synchronized rolling block demand. The rolling block demand requires that you choose a subinterval.

Figure 4–3: Demand sync pulse timing

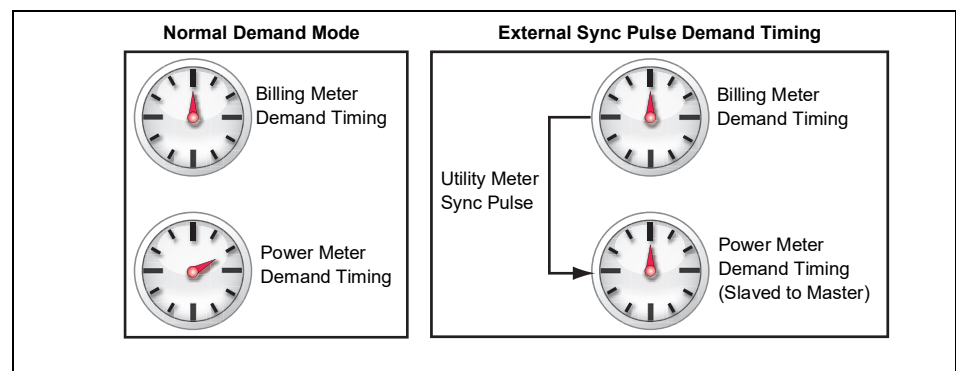

- **Command Synchronized Demand.** Using command synchronized demand, you can synchronize the demand intervals of multiple meters on a communications network. For example, if a PLC input is monitoring a pulse at the end of a demand interval on a utility revenue meter, you could program the PLC to issue a command to multiple meters whenever the utility meter starts a new demand interval. Each time the command is issued, the demand readings of each meter are calculated for the same interval. When setting up this type of demand, you select whether it will be command-synchronized block or command-synchronized rolling block demand. The rolling block demand requires that you choose a subinterval.

When in demand sync pulse control mode, the power meter will not end a demand interval without a pulse. The pulse must be received within +/- 5 seconds of when expected. If the pulse is not received in that time frame, the demand system is reinitialized.

### Thermal Demand

The thermal demand method calculates the demand based on a thermal response, which mimics thermal demand meters. The demand calculation updates at the end of each interval. You select the demand interval from 1 to 60 minutes (in 1-minute increments). In Figure 4-4 the interval is set to 15 minutes for illustration purposes.

**Figure 4-4: Thermal Demand Example**

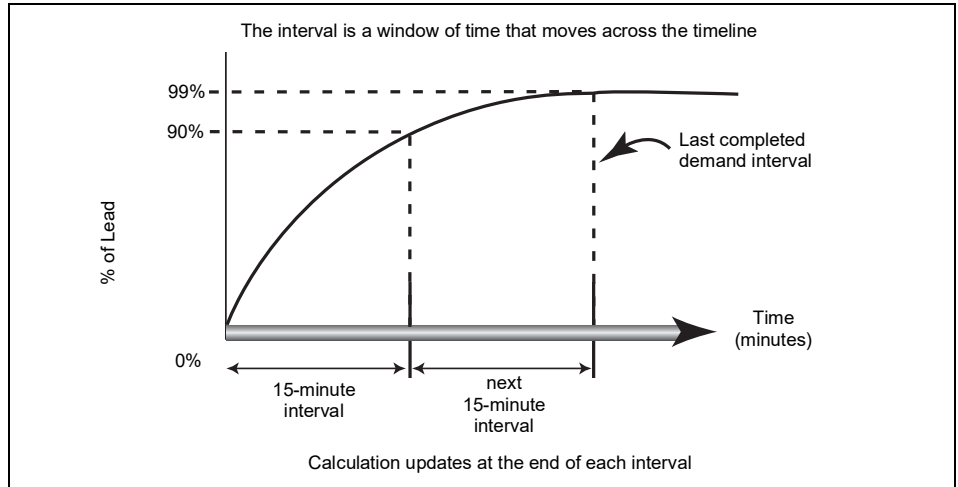

### Predicted Demand

The power meter calculates predicted demand for the end of the present interval for kW, kVAR, and kVA demand. This prediction takes into account the energy consumption thus far within the present (partial) interval and the present rate of consumption. The prediction is updated every second.

Figure 4-5 illustrates how a change in load can affect predicted demand for the interval.

**Figure 4-5: Predicted Demand Example**

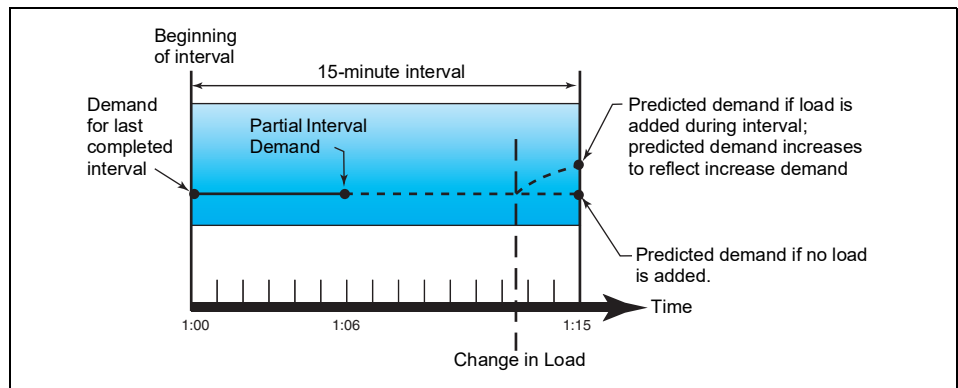

## Peak Demand

In nonvolatile memory, the power meter maintains a running maximum for power demand values, called “peak demand.” The peak is the highest average for each of these readings: kWd, kVARD, and kVAD since the last reset. The power meter stores the date and time when the peak demand occurred, as well as the peak demand during the last incremental energy interval.

You can reset peak demand values from the power meter display. To reset all demand values, select Maint > Reset > Global Resets > Demands. To reset power or current demand values, select Maint > Reset > Single Resets > Demand, then select Power or Current. See “Reset the Power Meter” on page 25 for more information.

You should reset peak demand after changes to basic power meter setup, such as CT ratio or power system configuration.

## Energy Readings

The power meter calculates and stores accumulated energy values for real, reactive, and apparent energy. Energy is stored as Delivered, Received, Del+Rec, and Del-Rec.

You can view accumulated energy from the display. The resolution of the energy value automatically changes from kWh to MWh (kVAh to MVARh).

Energy values can be reported over communications as 64-bit signed integers. The units are always Wh, VARh, or VAh.

## Power Analysis Values

The power analysis values use the following abbreviations:

$$\text{HC (Harmonic Content)} = \sqrt{H_2^2 + H_3^2 + H_4^2 + \dots}$$

$H_1$  = Fundamental Content

$I_L$  = Maximum Demand Load

The power meter provides the following power analysis values:

- **THD.** Total Harmonic Distortion (THD) is a quick measure of the total distortion present in a waveform and is the ratio of harmonic content to the fundamental. It provides a general indication of the “quality” of a waveform. THD is calculated for both voltage and current. The power meter uses the following equation to calculate THD:

$$\text{THD} = \frac{\text{HC}}{H_1} \times 100\%$$

- **thd.** An alternate method for calculating Total Harmonic Distortion. It considers the total harmonic current and the total rms content rather than fundamental content in the calculation. The power meter calculates thd for both voltage and current. The power meter uses the following equation to calculate thd:

$$\text{thd} = \frac{\text{HC}}{\sqrt{H_1^2 + \text{HC}^2}} \times 100\%$$

- **TDD.** Total Demand Distortion (TDD) evaluates the harmonic currents between an end user and a power source. The harmonic values are based on a point of common coupling (PCC), which is a common point where each user receives power from the power source. The power meter uses the following equation to calculate TDD:

$$\text{TDD} = \frac{\sqrt{\text{HC}_{IA}^2 + \text{HC}_{IB}^2 + \text{HC}_{IC}^2}}{I_L} \times 100\%$$

## View or Modify Configuration Data using ION Setup

You can use ION Setup to view or modify the meter setup parameters.

For more information on configuration, see ION Setup 3.0 Device configuration guide.

## Chapter 5—Alarms

### **⚠ WARNING**

#### **HAZARD OF UNDELIVERED NOTIFICATIONS**

Do not rely solely on the power meter for alarm notifications where human or equipment safety relies on successfully delivered notifications.

**Failure to follow these instructions can result in death, serious injury, or equipment damage.**

## About Alarms

The ⚠ icon appears in the upper-right corner of the meter display when an alarm is active.

If the energy/alarm LED has been configured for alarms, the energy/alarm LED flashes when an alarm is active. See “Setting Up the Energy/Alarm LED” on page 60 for more information.

The power meter maintains a counter for each alarm to keep track of the total number of occurrences (see Figure 5–1).

**Figure 5–1: Alarm Counters**

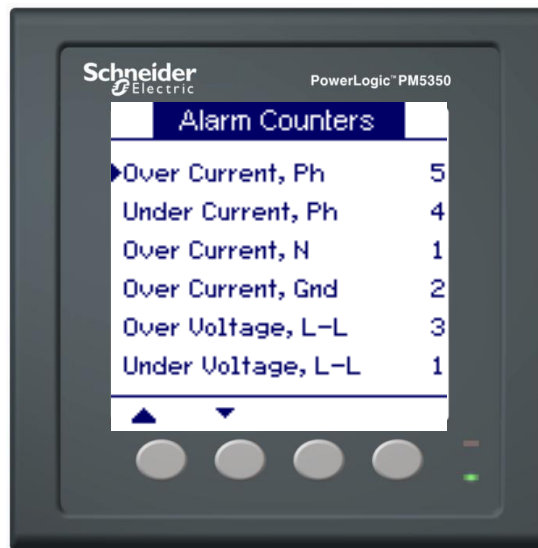

If you make changes to the basic power meter setup, all alarms are disabled to prevent undesired alarm operation. Confirm alarm configuration and enable required alarms.

**NOTE:** Only alarms that apply to the selected power system configuration can be enabled.

The available alarms for this power meter are described in the following sections.

## 1-Second Alarms

The power meter has 29 standard 1-second over/under alarms. See Table 5–1 for a complete list.

Use the display to configure 1-second alarms with the following values:

- Enable—disable (default) or enable
- Pickup Setpoint (magnitude)
- Pickup Time Delay (in seconds)
- Dropout Setpoint (magnitude)
- Dropout Time Delay (in seconds)

**Table 5–1: List of Standard 1-Second Over/Under Alarms**

Alarm Number	Alarm Label
01	Over Current, Phase
02	Under Current, Phase
03	Over Current, Neutral
04	Over Current, Ground
05	Over Voltage, L-L
06	Under Voltage, L-L
07	Over Voltage, L-N
08	Under Voltage L-N
09	Over kW
10	Over kVAR
11	Over kVA
12	Lead PF, True
13	Lag PF, True
14	Lead PF, Disp
15	Lag PF, Disp
16	Over kW Dmd, Pres
17	Over kW Dmd, Last
18	Over kW Dmd, Pred
19	Over kVAR Dmd, Pres
20	Over kVAR Dmd, Last
21	Over kVAR Dmd, Pred
22	Over kVA Dmd, Pres
23	Over kVA Dmd, Last
24	Over kVA Dmd, Pred
25	Over Frequency
26	Under Frequency
27	Over Voltage Unbal
28	Over Voltage THD
29	Phase Loss



Many of the 1-second alarms are three-phase alarms. Alarm setpoints are evaluated for each of the three phases individually, but the alarm is reported as a single alarm. The alarm pickup occurs when the first phase exceeds the alarm pickup magnitude for the pickup time delay. The alarm is active as long as any phase remains in an alarm state. The alarm dropout occurs when the last phase drops below the dropout magnitude for the dropout time delay. See Figure 5–2 below.

**Figure 5–2: How the power meter handles setpoint-driven alarms**

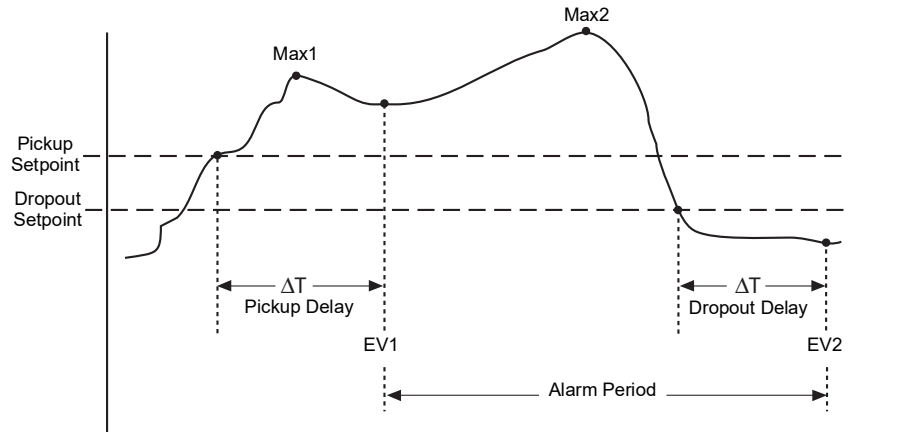

**EV1**—The power meter records the date and time that the pickup setpoint and time delay were satisfied, and the maximum value reached (Max1) during the pickup delay period ( $\Delta T$ ). Also, the power meter performs any tasks assigned to the event such as operation of a digital output.

**EV2**—The power meter records the date and time that the dropout setpoint and time delay were satisfied, and the maximum value reached (Max2) during the alarm period.

## Unary Alarms

The power meter has four unary alarms. These alarms alert you when the meter powers on after a control power loss, when the meter resets for any reason, when the meter self-diagnostic feature detects a problem, or when the meter detects a phase rotation different than expected.

## Digital Alarms

The power meter has four digital alarms for alarming on digital input status. By default, the digital alarms are active when the associated digital input is on. The pickup and dropout time delays are configured in seconds.

## Multi Circuit Alarms

Multi-circuit alarms are only available for setup when Multi Circuit circuit mode is selected. See Appendix E on page 77 for information on multi-circuit alarms.

## Alarm Priorities

Each alarm has a priority level. Use priorities to distinguish between events that require immediate action and those that do not require action. See “Setting Up the Energy/Alarm LED” on page 60 for information on configuring the alarm LED for alarm mode.

- **High priority**—if a high priority alarm occurs, the display informs you in two ways: the alarm LED on the display flashes until you acknowledge the alarm, and the alarm icon blinks while the alarm is active. An alarm message is displayed while the alarm is active. See “Viewing Unacknowledged Alarms and the Alarm History Log” on page 49 for information on acknowledging alarms.
- **Medium priority**—if a medium priority alarm occurs, the alarm LED and the alarm icon blink only while the alarm is active. An alarm message is displayed while the alarm is active.
- **Low priority**—if a low priority alarm occurs, the alarm LED and the alarm icon blink only while the alarm is active. No alarm message is displayed.
- **No priority**—if an alarm is set up with no priority, no visible representation appears on the display. Alarms with no priority are not entered in the alarm Log.

If multiple alarms with different priorities are active at the same time, the display shows the alarms in the order they occurred. See “Setting Up Alarms” on page 20 for instructions on setting up alarms from the power meter display.

When a pickup event occurs, the active alarm list appears. Press “Detail” to see more event information. See “Alarm Setup” on page 42 for more information.

## Using an Alarm to Control a Relay Output

Relays can be configured as external, demand sync, and alarm. See the “Setting Up Alarms” sections in this chapter and “Setting Up the Digital Output” on page 56.

## Alarm Setup

Evaluation of all alarms is temporarily suspended while alarm setup screens are displayed. Evaluation resumes immediately upon exit from alarm setup screens.

To set up standard alarms:

1. Scroll to [Maint] in the menu list.
2. Press [Maint].
3. Press [Setup].
4. Enter your setup password.

**NOTE:** The default password is 0000. See “Setting Up Passwords” on page 24 for information on changing passwords.

5. Press [Alarm].

Use the directions in the following sections to set up alarms.

## Setting Up 1-Second Alarms

To set up a standard alarm:

1. Press [1-Sec]. The 1-second alarm Select screen appears.
2. Press ▼ and ▲ to scroll through the list of standard 1-second alarms.
3. Press [Edit] to select an alarm to be configured.
4. Press [Edit] to select Pickup Setpoint.
5. Press + to increment the active digit through the numerals 0-9.
6. Press ◀ to enter the selected value for the active digit and move to the next digit to the left.
7. Continue until all values are selected, then press [OK] to enter the selected number for the pickup setpoint.
8. For power factor alarms (Lead PF, True; Lag PF, True; Lead PF, Disp; and Lag PF, Disp) press ▼ to select PU Set Point Lead/Lag, then press [Edit]. For other alarms, skip to Step 12.
9. Press + and - to scroll between Lead and Lag.
10. Press [OK] to set the pickup set point lead or lag.
11. Press ▼ and follow Steps 4 to 7 for Pickup Time Delay and Dropout Setpoint.
12. For power factor alarms, press ▼ to select DO Set Point Lead/Lag and follow Steps 10 and 11. For other alarms, proceed to Step 14.
13. Press ▼ and follow Steps 4 to 7 for Dropout Time Delay.
14. Press ▼ to select Enable, then press [Edit].
15. Press + and - to scroll between Yes and No.
16. Press [OK] to enable or disable the alarm.

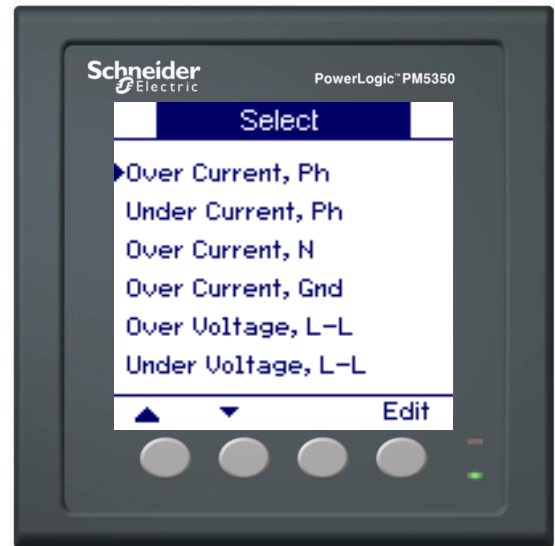

## Setting Up 1-Second Alarms (continued)

17. Press ▼ to select Priority, then press [Edit].
18. Press + and - to scroll through priority options None, High, Medium, or Low.  
**NOTE:** See “Alarm Priorities” on page 41 for more information.
19. Press [OK] to set the priority.
20. Press ▼ to select Select Digital Output, then press [Edit].
21. Press + and - to scroll through the list of digital outputs to associate with the alarm.
22. Press [OK] to select a digital output to be associated with the selected alarm.
23. If the selected digital output already has an association that will be lost by making the new selection, a confirmation screen appears.
  - Press [Yes] to accept the changes and return to the previous screen.
  - Press [No] to keep the existing configuration in use and return to the previous screen.
24. Press ▲ to save all alarm selections and return to the previous screen.
25. Press ▲ to save all 1-second alarm selections.

**NOTE:** The Over Demand alarms are applicable for systems in which the energy is delivered to the customer only.



## Setting Up Unary Alarms

To set up unary alarms:

1. Press [Unary]. The unary alarm Select screen appears.
2. Press ▼ and ▲ to scroll through the list of unary alarms.
3. Press [Edit] to select an alarm to be configured.
4. Press [Edit] to select Enable.
5. Press + and - to scroll between Yes and No.
6. Press [OK] to enable or disable the alarm.
7. Press ▼ to select Priority.
8. Press + and - to scroll through priority options Low, None, High, or Medium.

**NOTE:** See “Alarm Priorities” on page 41 for more information.

9. Press [OK] to set the priority.
10. Press ▼ to select Select Digital Output, then press [Edit].

**NOTE:** The digital output behavior mode must be Timed or Coil Hold to turn on when a unary alarm event occurs.

11. Press + and - to scroll through the list of digital outputs to associate with the alarm.
12. Press [OK] to select a digital output to be associated with the selected alarm.
13. If the selected digital output already has an association that will be lost by making the new selection, a confirmation screen appears.
  - Press [Yes] to accept the changes and return to the previous screen.
  - Press [No] to keep the existing configuration in use and return to the previous screen.
14. Press ▲ to save all alarms selections and return to the previous screen.
15. Press ▲ to save all unary alarm selections.



## Setting Up Digital Alarms

To set up digital alarms:

1. Press [Dig]. The digital alarm Select screen appears.
2. Press ▼ and ▲ to scroll through the list of digital alarms.
3. Press [Edit] to select an alarm to be configured.
4. Press [Edit] to select Pickup Setpoint, then press [Edit].
5. Press + and - to scroll between On and Off.
6. Press [OK] to enter the pickup setpoint.
7. Press ▼ to select Pickup Time Delay, then press [Edit].  
**NOTE:** If the selected digital input mode is Demand Sync or Input Metering, a confirmation screen appears warning that if an alarm is enabled for this digital input, the existing association will be broken.
8. Press + to increment the active digit through the numerals 0-9.  
**NOTE:** Units for time delays are set in seconds.
9. Press ◀ to enter the selected value for the active digit and move to the next digit to the left.
10. Continue until all values are selected, then press [OK] to enter the pickup time delay.
11. Press ▼ to select Dropout Time Delay, then press [Edit].
12. Follow Steps 8 to 11 for the dropout time delay.



## Setting Up Digital Alarms (continued)

13. Press ▼ to select Enable, then press [Edit].
14. Press + and - to scroll between Yes and No.
15. Press [OK] to enable or disable the alarm.
16. Press ▼ to select Priority, then press [Edit].
17. Press + and - to scroll through priority options None, High, Medium, or Low.  
**NOTE:** See “Alarm Priorities” on page 41 for more information.
18. Press [OK] to set the priority.
19. Press ▼ to select Select Digital Output, then press [Edit].
20. Press + and - to scroll through the list of digital outputs to associate with the alarm.
21. Press [OK] to select a digital output to be associated with the selected alarm.
22. If the selected digital output already has an association that will be lost by making the new selection, a confirmation screen appears.
  - Press [Yes] to accept the changes and return to the previous screen.
  - Press [No] to keep the existing configuration in use and return to the previous screen.
23. Press ▲ to save all alarm selections and return to the previous screen.
24. Press ▲ to save all digital alarm selections.



## Viewing Alarm Activity and History

The active alarm list holds 40 entries at a time. The list works as a circular buffer, replacing old entries as new entries over 40 are entered into the alarm event queue. The information in the alarm event queue is volatile and reinitializes when the power meter resets.

The alarm history log holds 40 entries. The log also works as a circular buffer, replacing old entries with new entries. This information is nonvolatile.

The Detail menu displays the following information for active and historical alarms:

- Alarm name
- Date and time of the event
- Event —pickup or dropout
- Phase—phase the event occurred on based on power system type
- Value—alarm trigger point

## Viewing Active Alarms and Alarm Counters

To view active alarms or alarm counters:

1. Scroll through the menu list at the bottom of the screen until you see [Alarm].
2. Press [Alarm].
3. Press the button beneath [Active] or [Count].
4. Press ▼ and ▲ to scroll through the alarm list.
5. Press ▲ to return to the previous screen.



Alarm Counters	
Over Current, Ph	5
Under Current, Ph	4
Over Current, N	1
Over Current, Gnd	2
Over Voltage, L-L	3
Under Voltage, L-L	1



## Viewing Unacknowledged Alarms and the Alarm History Log

To view the unacknowledged alarms or the alarm history log:

1. Scroll through the menu list at the bottom of the screen until you see [Alarm].
2. Press [Alarm].
3. Press the button beneath [Unack] or [Hist].
4. Press ▼ and ▲ to scroll through the list of primary alarm events.
5. Press [Detail] to view pickup and dropout event details.
6. Press ▼ and ▲ to scroll through the pickup and dropout event details.
7. For unacknowledged alarms, press [Ack] to acknowledge the alarm.
8. Press ▲ to return to the alarm list on the previous screen.
9. For unacknowledged alarms, follow Steps 4 to 7 until all alarms are acknowledged.



The image shows a close-up of the 'Alarm History' screen on the meter. The title is 'Alarm History'. Below the title, it says 'Meter Reset' followed by the date and time '02/02/11 12:00:00 AM'. There is a table with two columns: 'Event' and 'Unary'. The table contains the following data:

Event	Unary
Phase	None
Value	0

At the bottom of the screen, there is an upward-pointing arrow button.



## Chapter 6—Input/Output Capabilities

### **WARNING**

#### **UNINTENDED EQUIPMENT OPERATION**

- Do not use this device for critical control or protection applications where human or equipment safety relies on the operation of the control action.
- Do not rely solely on device data to determine if your power system is functioning correctly or meeting all applicable standards and compliances.
- Do not use device control for time-critical functions because delays can occur between the time a control action is initiated and when that action is applied.
- Do not use digital inputs for voltage sensing applications over 36 Vdc.

**Failure to follow these instructions can result in death, serious injury, or equipment damage.**

Digital inputs and outputs can be used in both Normal and Multi Circuit circuit modes. See Appendix E on page 77 for input/output capabilities in multi circuit mode.

## Digital Inputs

The power meter can accept four digital inputs designated DI1, DI2, DI3, and DI4. A digital input detects digital signals and is event-driven. For example, the Off-to-On transition of a digital input can be used to determine circuit breaker status, count pulses, or count motor starts.

The power meter counts Off-to-On transitions for each input. The count can be reset using the command interface (see Appendix D “Command Interface” on page 73) or by performing a reset (see “Reset the Power Meter” on page 25).

The digital input has two control modes:

- **Normal**—Use for simple On/Off digital inputs. The digital inputs can be configured to activate an alarm when changing status, for example, from Off to On. See “Alarms” on page 39.
- **Demand Interval Sync Pulse**—Use to configure a digital input to accept a demand sync pulse from a utility demand meter. See the Input Synchronized Demand section of “Synchronized Demand” on page 34.

## Setting Up the Digital Inputs

To begin digital input setup:

1. Scroll to [Maint] in the menu list.
2. Press [Maint].
3. Press [Setup].
4. Enter your setup password.

**NOTE:** The default password is 0000. See “Setting Up Passwords” on page 24 for information on changing passwords.

5. Press [I/O].
6. Press [D In].

To set up the digital inputs:

1. Press ▼ and ▲ to scroll through the list of digital inputs.
2. Press [Edit] to select a digital input.
3. Press ▼ to select Debounce Time, then press [Edit].
4. Press + to increment the active digit through the numerals 0-9.  
**NOTE:** Units for debounce time are set in 10 millisecond increments.
5. Press ◀ to enter the selected value for the active digit and move to the next digit to the left.
6. Continue until all values are selected, then press [OK] to enter the selected number for Debounce Time.



The following sections describe the steps for setting up the input in each control mode.

### Setting Up the Digital Inputs in Normal Mode

1. Press ▼ to select Control Mode, then press [Edit].
2. Press + and - to scroll through the list of control mode options.
3. Press [OK] to select Normal.
4. Press ▲ to save all selections

**NOTE:** If the selected digital input already has a demand system association, changing the mode displays a confirmation screen indicating that the previous associations will be lost. Press [Yes] to proceed, or [No] to go back to the previous screen.

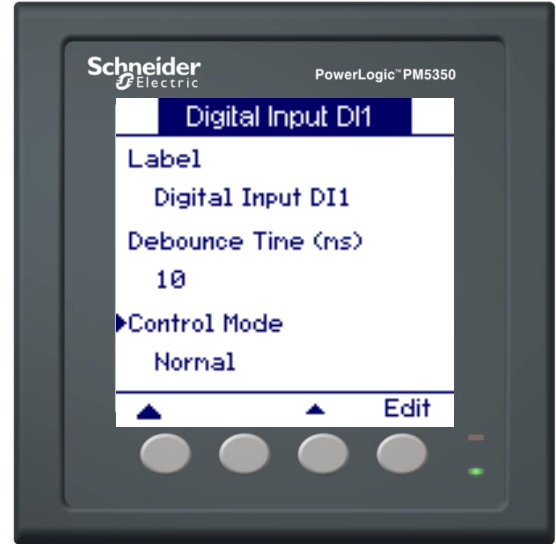

### Setting Up the Digital Inputs in Demand Sync Mode

1. Press ▼ to select Control Mode, then press [Edit].
2. Press + and - to scroll through the list of control mode options.
3. Press [OK] to select Select Dmd System.
4. Press ▼ to select Select Dmd System, then press [Edit].
5. Press + and - to scroll through a list of available demand systems.
6. Press [OK] to select a demand system.
7. Press ▲ to save all input selections and return to the previous screen.

**NOTE:** A confirmation screen appears. Press [Yes] to proceed, or [No] to go back to the previous screen.

8. Press ▲ to save all digital input selections.



When using a digital input for demand sync, the selected demand method must be “Input Synchronized Block,” or “Input Synchronized Rolling Block,” and the demand interval duration and demand subinterval duration configurations must be the expected durations. The demand sync pulse from the external meter must occur within +/- 5 seconds of the expected duration to be considered a valid sync pulse.

## Digital Outputs

The power meter has two relay outputs, DO1 and DO2. The relay outputs have three control modes:

- **External**—The default setting. The output is controlled by a command sent over the communications link.
- **Alarm**—The output is controlled by the power meter in response to an alarm condition. Multiple alarms can be associated with the same output simultaneously.
- **Demand Sync**—The output signals the end of a demand interval.

The relay outputs have a limited number of operations that depend on the load being switched. Review the relay specifications (“Power Meter Specifications” on page 65) to verify they are suitable for your application.

Depending on the selected control mode, the following behavior modes are available for the relay outputs:

- **Normal**
  - **External**<sup>1</sup>: The output turns on when the “energize” command is received and turns off when the “de-energize” command is received.
  - **Alarm**: The output turns on when an alarm is activated and turns off when it is deactivated.
- **Timed**
  - **External**<sup>1</sup>: The output turns on when the “energize” command is received and turns off after a user-configurable time.
  - **Alarm**: The output turns on when an alarm is activated and turns off after a user-configurable time. The alarm may still be active after the output has turned off.
  - **Demand Sync**: The output turns on at the end of the associated demand interval and stays on for a user-configurable time.
- **Coil Hold**
  - **External**<sup>1</sup>: The output turns on when the “energize” command is received and turns off when the “coil hold release” command is received. In the event of a control power loss, the output remembers and returns to the state it was in when the control power loss occurred.
  - **Alarm**: The output turns on when an alarm is activated and turns off when the “coil hold release” command is received.

<sup>1</sup> See Appendix D “Command Interface” on page 73 for information on commands and using the command interface.

The following sections describe the steps for setting up the output in each of the control modes and associated behavior modes.

### **WARNING**

#### **HAZARD OF UNINTENDED OPERATION**

- Do not use the PM5350 power meter for critical control or protection applications where human or equipment safety relies on the operation of the control circuit.
- An unexpected change of state of the digital outputs may result when the supply power to the meter is interrupted, after a meter firmware upgrade, or during front panel or remote configuration.

**Failure to follow these instructions can result in death, serious injury, or equipment damage.**

## Setting Up the Digital Output

To begin digital output setup:

1. Scroll to [Maint] in the menu list.
2. Press [Maint].
3. Press [Setup].
4. Enter your setup password.

**NOTE:** The default password is 0000. See “Setting Up Passwords” on page 24 for information on changing passwords.

5. Press [I/O].
6. Press [D Out].

To set up the digital outputs:

1. Press ▼ and ▲ to scroll through the list of digital outputs.
2. Press [Edit] to select a digital output.
3. Proceed to the following sections to configure the output in External, Alarm, or Demand Sync mode.





## Setting Up the Digital Output in External Mode

1. Press ▼ to select Control Mode, then press [Edit].
2. Press + and - to scroll through the list of control mode options.
3. Press [OK] to select External.  
**NOTE:** If the selected digital output is in Demand Sync or Alarm mode and has a demand system or alarm association, a confirmation screen appears warning that previous associations will be lost. Press [Yes] to proceed, or [No] to go back to the previous screen.
4. Press ▼ to select Behavior Mode, then press [Edit].
5. Press + and - to select a behavior mode.
6. Press [OK] to select the behavior mode.
7. Press ▼ to select On Time (s), then press [Edit].
8. Press + to increment the active digit through the numerals 0-9.
9. Press ◀ to enter the selected value for the active digit and move to the next digit to the left.
10. Continue until all values are selected, then press [OK] to enter the selected number for On Time (s).
11. Press ▲ to save all external mode output selections.  
**NOTE:** A confirmation screen appears. Press [Yes] to proceed, or [No] to go back to the previous screen.
12. Press ▲ to save all digital output selections.

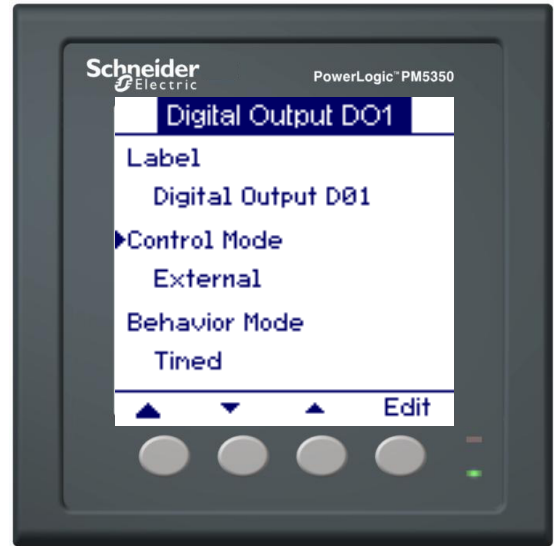

## Setting Up the Digital Output in Alarm Mode

1. Press ▼ to select Control Mode, then press [Edit].
2. Press + and - to scroll through the list of control mode options.
3. Press [OK] to select Alarm.  
**NOTE:** If the selected digital output is in Demand Sync mode and has a demand system association, a confirmation screen appears warning that previous associations will be lost. Press [Yes] to proceed, or [No] to go back to the previous screen.
4. Press ▼ to select Behavior Mode, then press [Edit].
5. Press + and - to select a behavior mode.
6. Press [OK] to select a behavior mode.
7. Press ▼ to select On Time (s), then press [Edit].
8. Press + to increment the active digit through the numerals 0-9.
9. Press ◀ to enter the selected value for the active digit and move to the next digit to the left.
10. Continue until all values are selected, then press [OK] to enter the selected number for On Time (s).
11. Press ▼ to select Select Alarms, then press [Edit].
12. Press ▼ and ▲ to scroll through a list of available alarms.  
**NOTE:** The digital output behavior mode must be Timed or Coil Hold to turn on when a unary alarm event occurs.
13. Press [Select] to select an alarm.  
**NOTE:** Any number of alarms can be associated with a digital output. An X appears next to the selected item(s). Press [Select] to remove an association.
14. Press ▲ to save all alarm mode output selections and return to the previous screen.  
**NOTE:** A confirmation screen appears. Press [Yes] to proceed, or [No] to go back to the previous screen.
15. Press ▲ to save all digital output selections.



## Setting Up the Digital Output in Demand Sync Mode

1. Press ▼ to select Control Mode, then press [Edit].
2. Press + and - to scroll through the list of control mode options.
3. Press [OK] to select Demand Sync.

**NOTE:** If the selected digital output is in Alarm mode and has an alarm association, a confirmation screen appears warning that previous associations will be lost. Press [Yes] to proceed, or [No] to go back to the previous screen.

4. Press ▼ to select Behavior Mode, then press [Edit].
5. Press + and - to select a behavior mode.
6. Press [OK] to select a behavior mode.
7. Press ▼ to select On Time (s) then press [Edit].
8. Press + to increment the active digit through the numerals 0-9.
9. Press ◀ to enter the selected value for the active digit and move to the next digit to the left.
10. Continue until all values are selected, then press [OK] to enter the selected number for On Time (s).
11. Press ▼ to select Select Dmd System then press [Edit].
12. Press + and - to scroll through a list of available demand systems.
13. Press [OK] to select a demand system.
14. Press ▲ to save all demand sync mode output selections and return to the previous screen.  
**NOTE:** A confirmation screen appears. Press [Yes] to proceed, or [No] to go back to the previous screen.
15. Press ▲ to save all digital output selections.



## Energy/Alarm LED

The energy/alarm LED has three modes: Off, Alarm, and Energy.

- **Off**— Turns off the LED.
- **Alarm**— The LED flashes when there is an active alarm.
- **Energy**— The LED flashes.

### Setting Up the Energy/Alarm LED

To begin energy/alarm LED setup:

1. Scroll to [Maint] in the menu list.
2. Press [Maint].
3. Press [Setup].
4. Enter your setup password.  
**NOTE:** The default password is 0000. See “Setting Up Passwords” on page 24 for information on changing passwords.
5. Press [I/O].
6. Press [LED].

To set up the energy/alarm LED:

1. Press [Edit] to select the Mode.
2. Press + and - to scroll through a list of modes.
3. Press [OK] to select the mode.
  - Off, continue to Step 11.
  - Alarm, continue to Step 11.
  - Energy, continue to Step 4.
4. Press ▼ to select Pulse Weight, then press [Edit].
5. Press + to increment the active digit through the numerals 0-9.
6. Press ◀ to enter the selected value for the active digit and move to the next digit to the left.
7. Continue until all values are selected, then press [OK] to enter the pulse weight.
8. Press ▼ to select Channel, then press [Edit].
9. Press + and - to scroll through a list of energy channels.
10. Press [OK] to enter the energy channel.
11. Press ▲ to save all selections.

## Chapter 7—Maintenance and Troubleshooting

### Password Recovery

If you lose your password, go to [www.se.com/support](http://www.se.com/support) to contact Schneider Electric Technical Support for password recovery assistance.

**NOTE:** Be sure to have your product information readily available when calling technical support.

### Power Meter Memory

The power meter uses its nonvolatile memory to retain all data and metering configuration values. Under the operating temperature range specified for the power meter, this nonvolatile memory has an expected life of at least 45 years.

**NOTE:** Life expectancy is a function of operating conditions and does not constitute any expressed or implied warranty.

### Identifying the Firmware Version, Model, and Serial Number

1. Scroll to [Maint] in the menu list.
2. Press [Maint].
3. Press [Diag].
4. Press [Info].
5. Press ▼ and ▲ to view the model, firmware (OS) version, serial number, and other power meter information.
6. Press ▲ to return to the maintenance screen.



## Additional Meter Status Information

### Meter

1. Scroll to [Maint] in the menu list.
2. Press [Maint].
3. Press [Diag].
4. Press [Meter].
5. View the power meter status.
6. Press ▲ to return to the Maintenance screen.

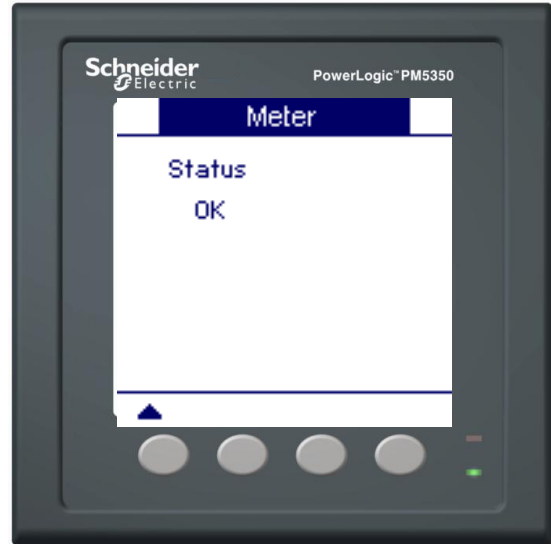

### Control Power

1. Scroll to [Maint] in the menu list.
2. Press [Maint].
3. Press [Diag].
4. Press [CI Pwr].
5. View control power information.
6. Press ▲ to return to the maintenance screen.

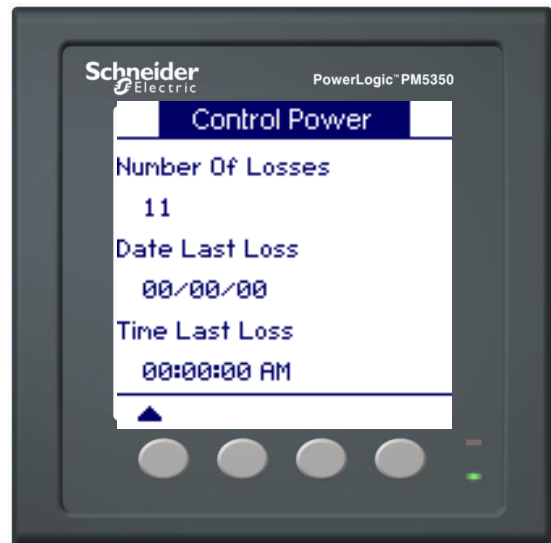



## Downloading Firmware

The power meter supports the downloading of new firmware and language files over the communications link. This requires the free DLF3000 software, which is available at [www.se.com](http://www.se.com). The DLF3000 offers an extensive Help file with information on operating the software. The most recent firmware and language files are also available on the website.

## Troubleshooting

The information in Table 7–1 on page 64 describes potential problems and their possible causes. It also describes checks you can perform or possible solutions for each. After referring to this table, if you cannot resolve the problem, contact your local Schneider Electric sales representative for assistance.

  **DANGER**

**HAZARD OF ELECTRIC SHOCK, EXPLOSION, OR ARC FLASH**

- Apply appropriate personal protective equipment (PPE) and follow safe electrical practices. For example, in the United States, see NFPA 70E.
- This equipment must be installed and serviced only by qualified personnel.
- Turn off all power supplying this equipment before working on or inside.
- Always use a properly rated voltage sensing device to confirm that all power is off.
- Carefully inspect the work area for tools and objects that may have been left inside the equipment.
- Use caution while removing or installing panels so that they do not extend into the energized bus; avoid handling the panels, which could cause personal injury.

**Failure to follow these instructions will result in death or serious injury.**

## Heartbeat/Communication LED

The heartbeat/communication LED helps to troubleshoot the power meter. The heartbeat/communication LED works as follows:

- **Normal operation** — the LED flashes at a steady rate during normal operation.
- **Communications** — the LED flash rate changes as the communications port transmits and receives data. If the LED flash rate does not change when data is sent from the host computer, the power meter is not receiving requests from the host computer.
- **Hardware** — if the heartbeat LED remains lit and does not flash On and Off, there is a hardware problem. Perform a hard reset of the power meter (turn Off power to the power meter, then restore power to the power meter). If the heartbeat LED remains lit, contact your local sales representative.
- **Control power and display** — if the heartbeat LED flashes, but the display is blank, the display may not be functioning properly or may have timed out (see “Setting Up the Display (continued)” on page 22). If the display is blank and the LED is not lit, verify that control power is connected to the power meter.

Table 7-1: Troubleshooting

Potential Problem	Possible Cause	Possible Solution
The maintenance (wrench) icon is illuminated on the power meter display.	When the maintenance (wrench) icon is illuminated, it indicates an event has occurred which may require attention.	Go to [Maint] > [Diag]. Event messages display to indicate the reason the icon is illuminated. Note these event messages and call Technical Support or contact your local sales representative for assistance.
The display is blank after applying control power to the power meter.	The power meter may not be receiving the necessary power. The display may have timed out.	Verify that the power meter line and terminals are receiving the necessary power. Verify that the heartbeat LED is blinking. Press a button to see if the display timed out.
The data being displayed is inaccurate or not what you expect.	Incorrect setup values.	Check that the correct values have been entered for power meter setup parameters (CT and VT ratings, Nominal Frequency, and so on). See "Setting Up the Power Meter" on page 10 for setup instructions.
	Incorrect voltage inputs.	Check power meter voltage input terminals L (8, 9, 10, 11) to verify that adequate voltage is present.
	Power meter is wired improperly.	Check that all CTs and VTs are connected correctly (proper polarity is observed) and that they are energized. Check shorting terminals. See the recommended torque in the Wiring section of the installation manual.
Cannot communicate with power meter from a remote personal computer.	Power meter address is incorrect.	Check to see that the power meter is correctly addressed. See "Setting Up Communications" on page 20 for instructions.
	Power meter baud rate is incorrect.	Verify that the baud rate of the power meter matches the baud rate of all other devices on its communications link. See "Setting Up Communications" on page 20 for instructions.
	Communications lines are improperly connected.	Verify the power meter communications connections. Refer to the Communications section in the installation guide for instructions.
	Communications lines are improperly terminated.	Check to see that a multipoint communications terminator is properly installed. See the Communications section in the installation guide for instructions.
	Incorrect route statement to power meter.	Check the route statement. Refer to the SMS online help for instructions on defining route statements.
Energy/Alarm LED not working.	May have been disabled by user.	See "LEDs" on page 7.

The power meter does not contain any user-serviceable parts. If the power meter requires service, contact your local sales representative. Do not open the power meter. Opening the power meter voids the warranty.

## Getting Technical Support

Please refer to the *Technical Support Contacts* provided in the power meter shipping carton for a list of support phone numbers by country, or go to [www.se.com](http://www.se.com), then navigate to the Support area for contact information.

## Register List

To download the latest version of the power meter PM5350 Modbus register list, go to [www.se.com](http://www.se.com). Type PM5350 in the search field. For information on using the register list to configure the power meter with the command interface, see Appendix D "Command Interface" on page 73.



## Appendix A—Specifications

### Power Meter Specifications

**Table A –1: Specifications**

Electrical Characteristics		
Type of Measurement		RMS including harmonics on three-phase AC system (3P, 3P + N) 32 samples per cycle, zero blind
Measurement Accuracy	Power, Phase	IEC 61557-12 Class 0.5 For 5A nominal CT (for 1A nominal CT when I > 0.15A) ±0.5% from 0.25A to 9A at COSφ = 1 ±0.6% from 0.50A to 9A at COSφ = 0.5 (ind or cap)
	Real Energy	IEC 62053-22 Class 0.5S, IEC 61557-12 Class 0.5 For 5A nominal CT (for 1A nominal CT when I > 0.15A) ±0.5% from 0.25A to 9A at COSφ = 1 ±0.6% from 0.50A to 9A at COSφ = 0.5 (ind or cap)
	Reactive Energy	IEC 62053-23 Class 2, IEC 61557-12 Class 2 For 5A nominal CT (for 1A nominal CT when I > 0.15A) ±2.0% from 0.25A to 9A at SINφ = 1 ±2.5% from 0.50A to 9A at SINφ = 0.25 (ind or cap)
	Frequency <sup>1</sup>	±0.05%
	Current, Phase <sup>1</sup>	±0.30%
	Voltage, L-N <sup>1</sup>	±0.30%
	Power Factor <sup>1</sup>	±0.005%
	<sup>1</sup> Measurements taken from 45 Hz to 65 Hz, 0.5A to 9A, 57V to 347V, and 0.5 ind to 0.5 cap power factor with a sinusoidal wave	
Data Update Rate		1 second nominal (50/60 cycles)
Input-Voltage	U <sub>nom</sub>	277 V L-N
	Measured Voltage with overrange and Crest Factor	Per IEC 61010-1 CAT III, 277 V L-N / 480 V L-L nominal CAT II, 400 V L-N / 690 V L-L nominal  Per UL 61010-1 and CSA C22.2 NO. 61010-1 CAT III, 300 V L-L
	Permanent Overload	700 Vac L-L 404 Vac L-N
	Impedance	10 MΩ
	Frequency Range	45 to 70 Hz
Input-Current	CT Ratings	Secondary 1A, 5A Nominal
	Measured Current with overrange and Crest Factor	5 mA to 9 A
	Withstand	Continuous 20A 10 sec/hr 50A 1 sec/hr 500A
	Impedance	< 0.3 mΩ
	Frequency Range	45 to 70 Hz
	Burden	< 0.024 VA at 9 A
AC Control Power	Operating Range	85 to 265 Vac
	Burden	4.1 VA / 1.5 W typical, 6.7 VA / 2.7 W maximum at 120 Vac 6.3 VA / 2.0 W typical, 8.6 VA / 2.9 W maximum at 230 Vac 11.9 VA / 3.5 W maximum at 265 Vac
	Frequency	45 to 65 Hz
	Ride-Through Time	100 mS typical at 120 Vac and maximum burden 400 mS typical at 230 Vac and maximum burden

**Table A –1: Specifications (continued)**

DC Control Power	Operating Range	100 to 300 Vdc
	Burden	1.4 W typical, 2.6 W maximum at 125 Vdc 1.8 W typical, 2.7 W maximum at 250 Vdc 3.2 W maximum at 300 Vdc
	Ride-Through Time	50 mS typical at 125 Vdc and maximum burden
Real Time Clock	Ride-Through Time	30 seconds
Digital Output	Number/Type	2 - Mechanical Relays
	Output Frequency	0.5 Hz maximum (1 second ON / 1 second OFF - minimum times)
	Switching Current	250 Vac at 2.0 Amps, 200k cycles, resistive 250 Vac at 8.0 Amps, 25k cycles, resistive 250 Vac at 2.0 Amps, 100k cycles, COSΦ=0.4 250 Vac at 6.0 Amps, 25k cycles, COSΦ=0.4 30 Vdc at 2.0 Amps, 75k cycles, resistive 30 Vdc at 5.0 Amps, 12.5k cycles, resistive <b>NOTE:</b> The COSΦ ratings are not evaluated for UL.
	Isolation	2.5 kVrms
Status Digital Inputs	Voltage Ratings	ON 18.5 to 36 Vdc OFF 0 to 4 Vdc
	Input Resistance	110k Ω
	Maximum Frequency	2 Hz (T <sub>on</sub> minimum = T <sub>off</sub> minimum = 250ms)
	Response Time	10 milliseconds
Whetting Output	Isolation	2.5 kVrms
	Nominal Voltage	24 Vdc
	Allowable Load	4 mA
Isolation		2.5 kVrms
Rated Impulse Voltage		2.5 KV
<b>Mechanical Characteristics</b>		
Weight		250 g
IP Degree of Protection (IEC 60529)		Designed to IP51 front display, IP30 meter body (Excluding connectors)
Dimensions (W x H x D)		96 x 96 x 44 mm (depth of meter from housing mounting flange) 96 x 96 x 13 mm (protrusion of meter from housing mounting flange)
Mounting Position		Vertical
Panel Thickness		6.35 mm maximum
<b>Environmental Characteristics</b>		
Operating Temperature	Meter	-25 to +70 °C (-13 to +158 °F)
	Display	-20 to +70 °C (-4 to +158 °F) (Display functions to -25 °C (-13 °F) with reduced performance)
Storage Temperature	Meter + Display	-40 to +85 °C (-40 to +185 °F)
Humidity Rating		5 to 95% RH at 50 °C (122 °F) (non-condensing)
Pollution Degree		2
Altitude		≤ 3000 m
Not suitable for wet locations.		
Indoor use only.		
<b>Electromagnetic Compatibility</b>		
Electrostatic Discharge		IEC 61000-4-2 <sup>2</sup>
Immunity to Radiated Fields		IEC 61000-4-3 <sup>2</sup>
Immunity to Fast Transients		IEC 61000-4-4 <sup>2</sup>
Immunity to Impulse Waves		IEC 61000-4-5 <sup>2</sup>
Conducted Immunity		IEC 61000-4-6 <sup>2</sup>
Immunity to Magnetic Fields		IEC 61000-4-8 <sup>2</sup>
Immunity to Voltage Dips		IEC 61000-4-11 <sup>2</sup>
Radiated Emissions		FCC Part 15 Class A, EN55011 Class A

**Table A –1: Specifications (continued)**

Conducted Emissions	FCC Part 15 Class A, EN55011 Class A	
Harmonics	IEC 61000-3-2 <sup>2</sup>	
Flicker Emissions	IEC 61000-3-3 <sup>2</sup>	
<sup>2</sup> As per IEC 61557-12 (IEC 61326-1)		
<b>Compliance</b>		
Europe	CE, as per IEC 61010-1 3rd Edition	
U.S. and Canada	UL 61010-1 and CAN/CSA-C22.2 No. 61010, 3rd Edition	
Measurement Category (Voltage Inputs)	Per IEC 61010-1 CAT III, 277 V L-N / 480 V L-L nominal CAT II, 400 V L-N / 690 V L-L nominal  Per UL 61010-1 and CSA C22.2 NO. 61010-1 CAT III, 300 V L-L	
Current Inputs (sensor connected)	Require external Current Transformer for Insulation	
Overvoltage Category (Control Power)	CAT III	
Overvoltage Category (Relay)	CAT II	
Dielectric Withstand	As per IEC 61010-1 Double insulated front panel display	
Protective Class	Class II	
<input type="checkbox"/> Double insulation at user-accessible area		
<b>Communications</b>		
RS-485 Port	2-wire, 9600, 19200, or 38400 baud; Parity— Even, Odd, None; 1 stop bit if parity Odd or Even, 2 stop bits if None; Modbus RTU, Modbus ASCII (7 or 8 bit), JBUS	
Firmware and Language File Update	Update via the communication port using DLF3000 software	
Isolation	2.5 kVrms	
<b>Human Machine Interface</b>		
Display	Type	Monochrome Graphics LCD
	Resolution	128 x 128
	Backlight	White LED
	Viewable Area (w x h)	67 x 62.5 mm
Keypad	Type	4 button
	Indicator	Green LED
<b>Energy Pulse Output/Active Alarm Indicator (configurable)</b>		
Type	Optical, amber LED	
Wavelength	590 to 635 nm	
Maximum Pulse Rate	2.5 kHz	



## Appendix B—Communications Wiring



### Communications Capabilities

Table B-1: RS-485 Communications Distances

Baud Rate	Maximum Communication Distances 1 to 32 Devices	
	Feet	Meters
9600	8,000	2,438
19200	6,000	1,829
38400	2,500	762

**NOTE:** Distances listed should be used as a guide only and cannot be guaranteed for non-PowerLogic devices. Refer to the master device's documentation for any additional distance limitations.

### Daisy-Chaining Devices to the Power Meter

  **DANGER**

**HAZARD OF ELECTRIC SHOCK, EXPLOSION, OR ARC FLASH**

- Do not attempt to service the power meter. CT and PT or VT inputs may contain hazardous currents and voltages.
- Only authorized service personnel from the manufacturer should service the power meter.
- Shield conductors may be energized if not properly connected.
- Shield wire should be installed per the device's installation instructions and grounded at one end only.

**Failure to follow these instructions will result in death or serious injury.**

The RS-485 slave port allows the power meter to be connected in a daisy chain with up to 31, 2-wire devices. In this document, communications link refers to a chain of devices that are connected by a communications cable.

Figure B-1: Daisy-chaining 2-wire devices

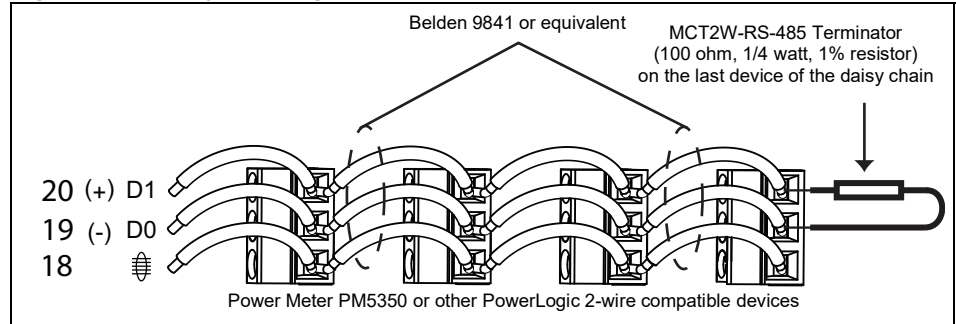

- If the power meter is the last device on the daisy chain, terminate it with the terminator provided.
- See Table B-1 for the maximum daisy-chain communications distances for 2-wire devices.
- The terminal's voltage and current ratings are compliant with the requirements of the EIA RS-485 communications standard.

## Appendix C—Power Factor Register Format

### Power Factor Register Format

Each power factor value (PF value) occupies one floating point register for power factor (PF register). The meter performs a simple algorithm to the PF value then stores it in the PF register. The meter and software interpret the PF register for all reporting or data entry fields according to the following diagram:

**Figure C-1: How PF value is stored in the PF register**

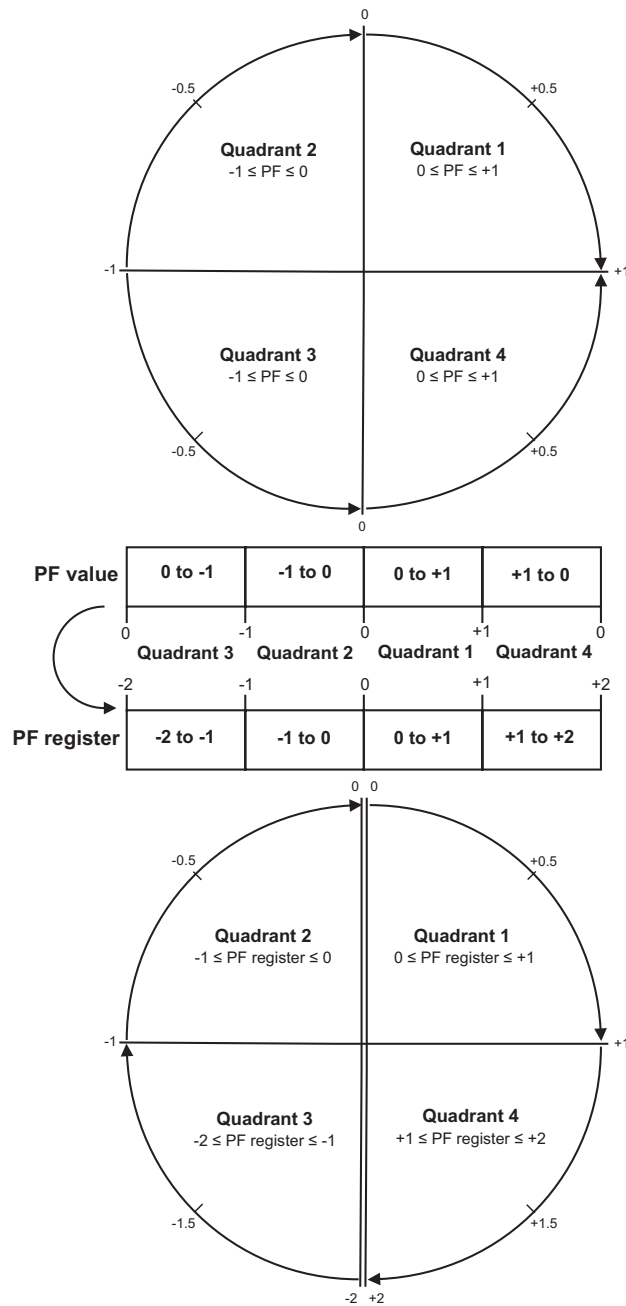

PF value is calculated from the PF register value using the following formulas:

**Table B-1: RS-485 Communications Distances**

Quadrant	PF range	PF register range	PF formula
Quadrant 1	0 to +1	0 to +1	PF value = PF register value
Quadrant 2	-1 to 0	-1 to 0	PF value = PF register value
Quadrant 3	0 to -1	-2 to -1	PF value = (-2) - (PF register value)
Quadrant 4	+1 to 0	+1 to +2	PF value = (+2) - (PF register value)



## Appendix D—Command Interface

<b>⚠ WARNING</b>
<b>UNINTENDED EQUIPMENT OPERATION</b>
Do not use this device for critical control or protection applications where human or equipment safety relies on the operation of the control action.
<b>Failure to follow these instructions can result in death, serious injury, or equipment damage.</b>

### Command Interface

The command interface allows you to configure the power meter by sending specific commands using Modbus protocol. Reference the online Modbus register list for meter commands, results, and data types. For information on accessing the register list, see “Register List” on page 64.

**Table D-1: Command Interface**

	Protected Command Interface	Unprotected Command Interface
Command Block	Register #	Register #
<b>A</b> Command	5000	5250
<b>B</b> Semaphore	5001	5251 (Ignored)
<b>C</b> Parameters	5002 - 5124	5252 - 5374
Meter Results	Register #	Register #
<b>D</b> Status	5125	5375
<b>E</b> Result	5126	5376
<b>F</b> Data	5127 - 5249	5377- 5499

- A. In the **Command** register, enter a meter command.
- B. In the **Semaphore** register, when using the protected command interface, enter the semaphore you are given (see “Using the Protected Command Interface” on page 74). The semaphore register is not used with the unprotected command interface (see “Using the Unprotected Command Interface” on page 75).
- C. In the **Parameters** register, enter all parameters for a meter command.
- D. The **Status** register displays 0 when the power meter receives a command. Once the command is completed, the status register displays the same value as the command register.
- E. The **Result** register indicates if the command was successful, and if not, what error may have occurred.
- F. The **Data** register displays the executed parameters of a successful command and the invalid parameters based on data type of an unsuccessful command.

There are two command interfaces, protected and unprotected, described in the following sections.

## Using the Protected Command Interface

To issue a meter command using the protected command interface, you must have a command semaphore.

To get a semaphore, read the semaphore Modbus register (see the “Command Interface” section of the online “Register List” on page 64). The power meter will return a 0 or a nonzero number.

- If 0 is returned, someone else owns the semaphore. You must wait for the semaphore to be available before sending a command.
- If a nonzero number is returned, you now own the semaphore. The semaphore is provided once until it is released or has been inactive for approximately 4 minutes. Once you have the semaphore, subsequent reads of the semaphore register will return 0 until you release the semaphore or it times out.

To send a meter command using the protected command interface:

1. Read the semaphore register and record the meter response. This is your semaphore.
2. Build the packet to be written to the command block.
3. Write the packet as a Modbus block write (enter the command number, semaphore, and parameters at the same time).

**Table D–2: Protected Command Block Example**

Command Block	Register #
Command	2039
Semaphore	5
Parameters	1

4. Monitor the meter response registers for validity and completion.

**Table D–3: Protected Meter Response Example**

Meter Response	Register #
Status	2039
Result	0
Data	1

5. Write the semaphore back to the semaphore register to release it for another master to use.

## Using the Unprotected Command Interface

The unprotected command interface allows you to issue a broadcast command to multiple meters at once. The unprotected command interface ignores the semaphore register.

Although some applications require the unprotected command interface, it is recommended that you use the protected command interface whenever possible.

To send a meter command using the unprotected command interface:

1. Build the packet to be written to the command block.
2. Write the packet as a Modbus block write (enter the command number, any number as the semaphore, and the parameters at the same time).

**Table D-4: Unprotected Command Block Example**

Command Block	Register #
Command	2039
Semaphore	—
Parameters	1

3. Monitor the meter response registers for validity and completion.

**Table D-5: Unprotected Meter Response Example**

Meter Response	Register #
Status	2039
Result	0
Data	1



## Appendix E—Multi Circuit Applications

### Overview

The Multi Circuit circuit mode allows you to monitor up to three loads connected to an electrical service with a single power meter. The power meter provides all standard metering quantities for each circuit independent of other circuits being monitored. In multi circuit mode, you can alarm on current, power, and power demand.

Multi Circuit mode allows for load management and balancing between circuits in a facility. For example, in a data center you can monitor each rack of servers and networking devices on a separate circuit. In addition, you can set up multi-level alarms to monitor overcurrent and undercurrent conditions on each circuit.

### Meter Identification

Only PM5350 meters with firmware (F/W) versions 02.00 and above can be used in a multi-circuit application. Refer to the product label on the rear of the meter or on the meter carton to verify the firmware version.

**Figure E-1: Power Meter Firmware Version**

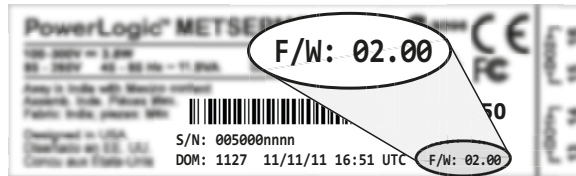

### Monitoring Circuits with Multi-Level Alarms

In Multi Circuit mode, you can set multi-level current (I) alarms, each with six alarm levels: Normal, Low Low, Low, High, High High, and Tripped. Setting an alarm segmented with multiple pickup and dropout setpoints allows you to gauge gradual changes in current on each circuit. You can then monitor the annunciation of multi-level alarms to balance circuit loads and avoid breaker trips and overheating.

**Example** A user with a 3CKT L-N system type has installed a 10 amp circuit breaker on I1 (Figure E-2) and has established the normal expected load for that circuit is 5 amps. The user wants to be notified if the current increases above 5 amps by 20% or by 40% of the circuit breaker rating or if the breaker trips.

See “Multi Circuit Alarms” on page 85 for a description of all alarm parameters and setup.

Alarm Setting	Example Value
Breaker rating	10 amps
High High PU%	90%
High High DO%	90%
High PU%	70%
High DO%	70%
Pickup Time Delay	1 second
Select Dig Input	Dig Input D11 <b>NOTE:</b> See “Monitoring for Tripped Status with a Digital Input” on page 91 for digital input wiring and alarm setup.

**Figure E-2: 3CKT L-N System Type Wiring Diagram**

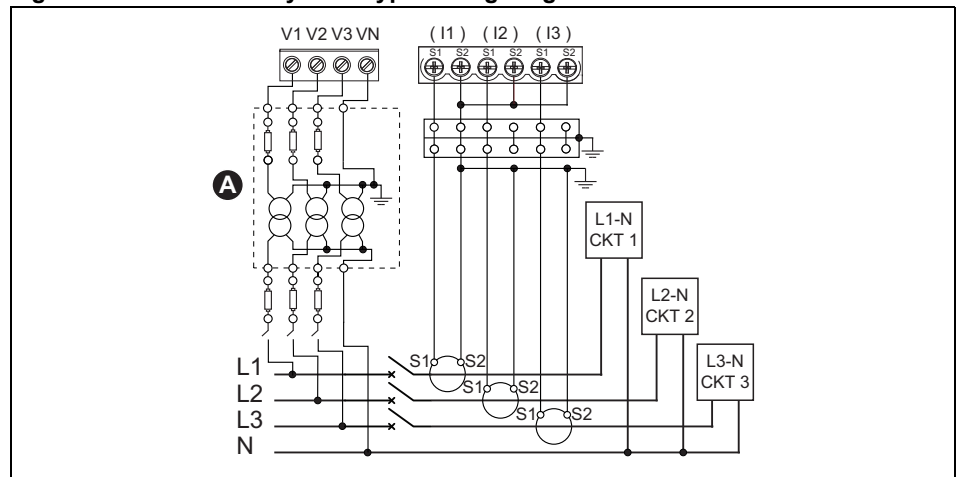

**Figure E-3: Alarm Pickup and Dropout on a 10 Amp Circuit**

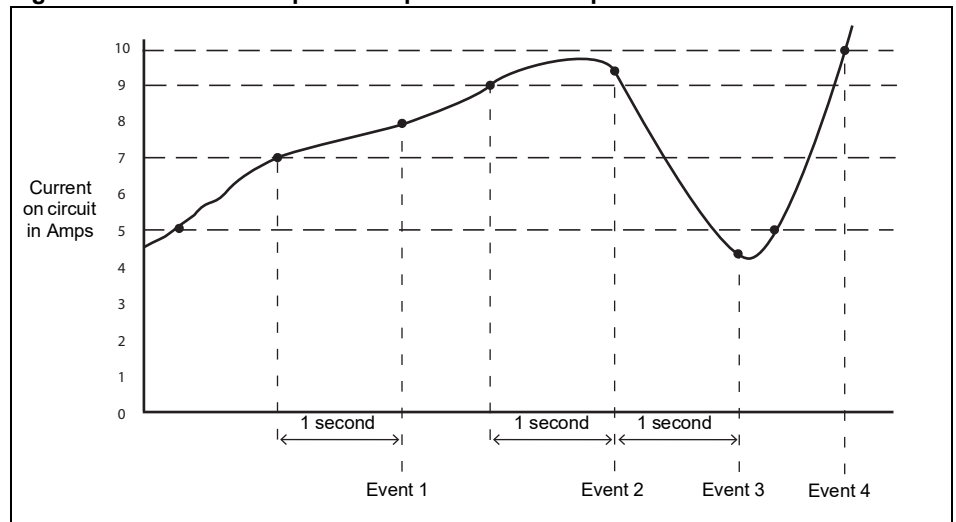

**Event 1**—Current increase triggers High Pickup.

**Event 2**—Current increase triggers High High Pickup.

**Event 3**—Current drop triggers High High Dropout.

**NOTE:** The last event prior to return to nominal current is the dropout of the last active pickup only.

**Event 4**—Current increase means breaker trip is expected.

**NOTE:** A current value in excess of the circuit breaker rating does not trigger the Tripped status. Only auxiliary contact closure on the digital input associated with the alarm will trigger the Tripped status.

## Multi Circuit Menu Overview

Below is the menu tree when a multi circuit system type is selected. “Menu Overview” on page 9 describes how to use the power meter navigation buttons.

**Figure E-4: Multi Circuit Menu Tree**

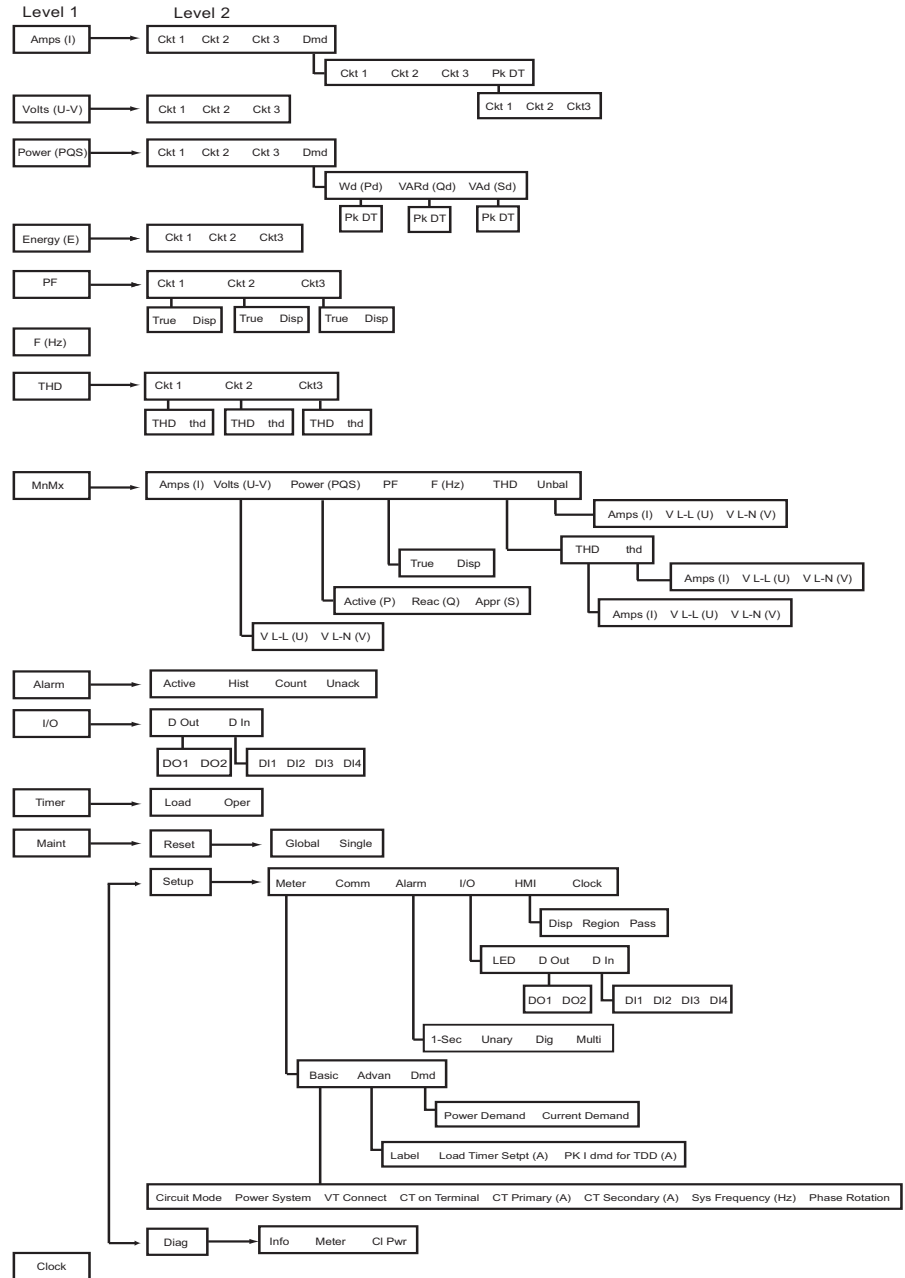

**NOTE:** The number of circuits available for viewing depends on your power system configuration.

## Basic Setup for Multi Circuit Mode

Follow the steps in “Power Meter Basic Setup” on page 10 to reach the basic setup screen.

To select the multi circuit mode:

1. Press [Edit] to select Circuit Mode.
2. Press + to scroll to Multi Circuit.
3. Press [OK] to select the Multi Circuit option.

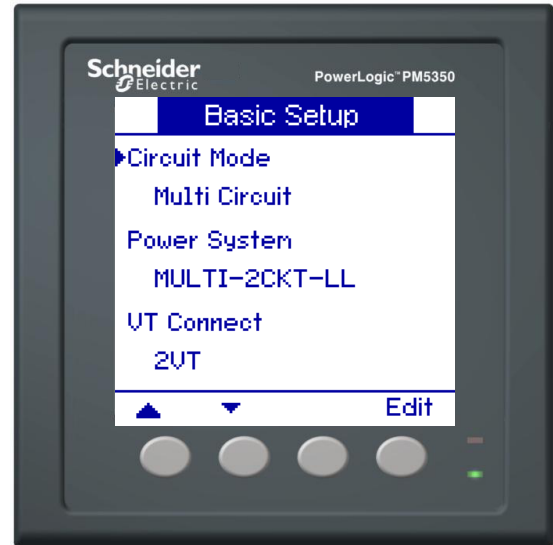

## Setting Up the Power System

To set up the power system for multi circuit mode:

1. Press ▼ to select Power System, then Press [Edit].
2. Press + and - to scroll through the list of supported power system configurations.
3. Press [OK] to select the power system configuration to be metered.

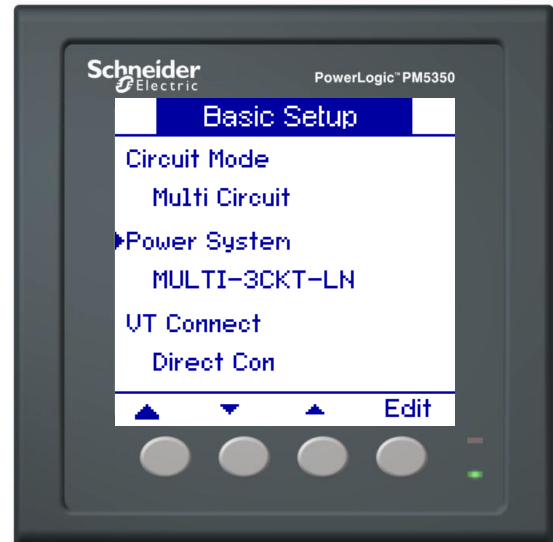



### Supported Power System Configurations

The power meter supports additional power system configurations in multi circuit mode. See Figure E-5 and Table E-1 for details.

**Figure E-5: Power System Configurations for Multi Circuit Applications**

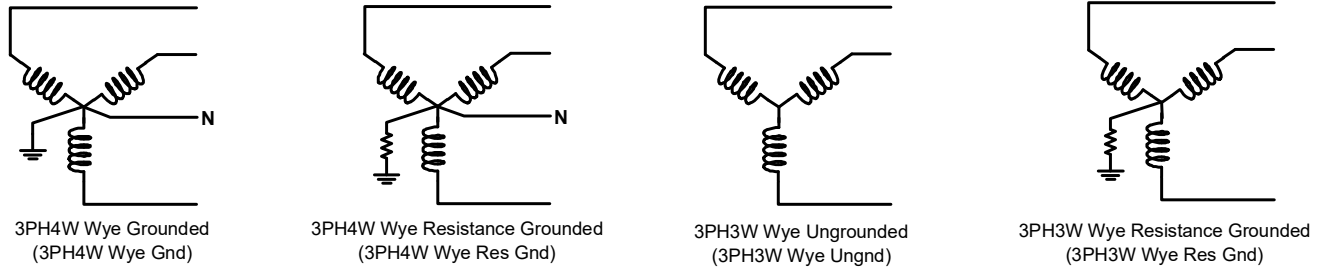

**Table E-1: Power System Configurations for Multi Circuit Applications**

Power System Configuration	Number of Wires	CTs		Voltage Connections		
		Qty.	Meter Terminal	Qty.	Meter Terminal <sup>1</sup>	Type
MULTI-3CKT-LN	4	3	I1, I2, I3	3	V1, V2, V3 (VN to Ground)	Wye
MULTI-2CKT-LL	3	2	I2, I3	2	V1-V3, V2-V3 (V3 to Ground)	Wye
	3	2	I1, I3	2	V2-V1, V3-V1 (V1 to Ground)	Wye
	3	2	I1, I2	2	V3-V2, V1-V2 (V2 to Ground)	Wye
MULTI-CKT-WYE	4	3	I1, I2, I3	3	V1, V2, V3 (VN to Ground)	Wye

<sup>1</sup> Refer to the wiring diagrams in the PowerLogic™ Power Meter PM5350 Series Multi-Circuit Installation Guide, part number EAV25860.

## Setting Up Voltage Connection and CT Options

The options available for voltage connections (VT Connect) and the number of CTs that can be selected (CT on Terminal) depend on the power system selected in “Setting Up the Power System” on page 80.

To set up voltage connections and CTs in Multi Circuit mode:

1. Press ▼ to select VT Connect, then press [Edit].
2. Press + and - to scroll through the VT Connect options.
3. Press [OK] to select the VT Connect. If you choose Direct Con, skip to step 10.
4. Press ▼ to select VT Primary (V), then press [Edit].
5. Press + and - to scroll through the options.
6. Press [OK] to select VT Primary (V).
7. Press ▼ to select VT Secondary (V), then press [Edit].
8. Press + and - to scroll through the options.
9. Press [OK] to select VT Secondary (V).
10. Press ▼ to select CT on Terminal, then press [Edit].
11. Press + and - to scroll through the terminal options.  
**NOTE:** Options are based on the selected power system.
12. Press [OK] to enter the terminals the CTs are on.
13. Press ▼ to select CT Primary (A), then press [Edit].
14. Press + to increment the active digit through the numerals 0-9.
15. Press ◀ to enter the selected value for the active digit and move to the next digit to the left.
16. Continue until all values are selected, then press [OK] to enter the CT Primary.

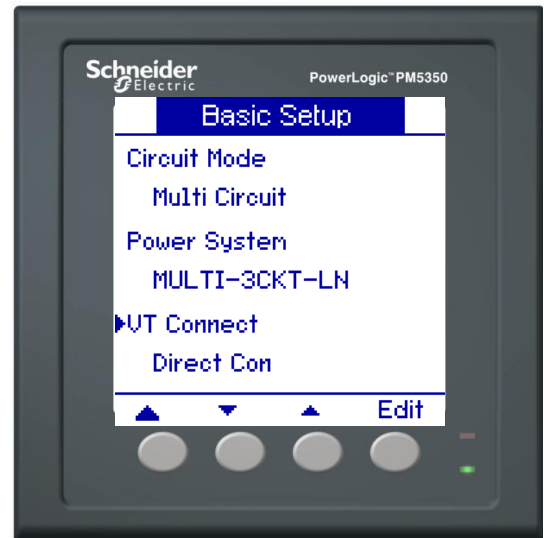

## Setting Up Voltage Connection and CT Options (continued)

17. Press ▼ to select CT Secondary (A), then press [Edit].

18. Press + and - to scroll through a list of CT Secondary options.

**NOTE:** CT Secondary options are 5A or 1A. See “Specifications” on page 65 for accuracy level.

19. Press [OK] to select the CT Secondary.

20. Press ▲ to return to the previous screen.

**NOTE:** If existing associations will be lost by making the new selection, a confirmation screen appears.

- Press [Yes] to accept the changes and return to the previous screen.
- Press [No] to keep the existing configuration and return to the previous screen.

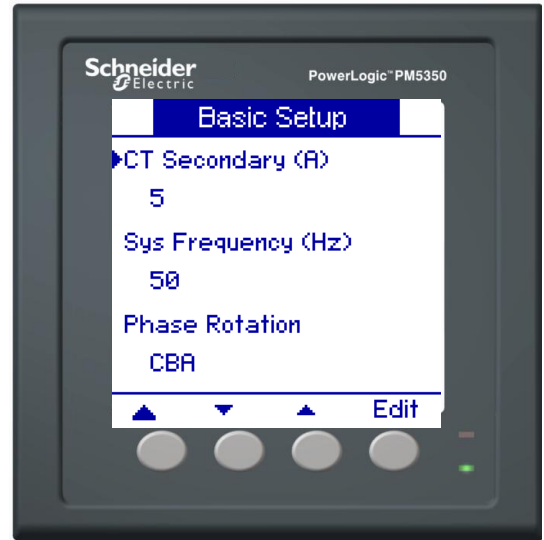

## Metering

The power meter characteristics below are specific to multi circuit mode. See “Power Meter Characteristics” on page 29 for a list of all power meter characteristics.

**Table E-2: Power Meter Characteristics in Multi Circuit Mode**

<b>Energy Values Per Circuit</b>	
Active energy (Delivered)	0 to $9.2 \times 10^{18}$ Wh
Reactive energy (Delivered + Received)	0 to $9.2 \times 10^{18}$ VARh
Apparent energy (Delivered)	0 to $9.2 \times 10^{18}$ VAh
<b>Demand Values</b>	
Current	Average Per circuit
Active, reactive, apparent power	Total Per circuit
<b>Maximum Demand Values</b>	
Maximum current	Per circuit
Maximum active power	Total Per circuit
Maximum reactive power	Total Per circuit
Maximum apparent power	Total Per circuit

**Table E-3: Demand Readings**

<b>Demand Current, Average or Per Circuit</b>
Last Complete Interval
Present Incomplete Interval
Predicted
Peak
<b>Demand Real Power, 3Ø Total or Per Circuit</b>
Last Complete Interval
Present Incomplete Interval
Predicted
Peak
<b>Demand Reactive Power, 3Ø Total or Per Circuit</b>
Last Complete Interval
Present Incomplete Interval
Predicted
Peak
<b>Demand Apparent Power, 3Ø Total or Per Circuit</b>
Last Complete Interval
Present Incomplete Interval
Predicted
Peak

## Multi Circuit Alarms

The power meter has nine multi circuit alarms. These alarms are only available when Multi Circuit mode is selected. Alarms and alarm parameters are listed below.

**Table E-4: List of Multi Circuit Alarms**

Alarm Label	Alarm Parameters	Value/Options
MultiLevel I Ckt 1 MultiLevel I Ckt 2 MultiLevel I Ckt 3	Breaker Rating	Amps
	High High PU%	Percent of circuit breaker rating <sup>1</sup>
	High High DO%	
	High PU%	
	High DO%	
	Low PU%	
	Low DO%	
	Low Low PU%	
	Low Low DO%	
	Pickup Time Delay	
	Enable	Disable (default) or enable
	Priority	None (default), medium, low <sup>2</sup>
	Select Dig Input	None, Dig Input DI1, Dig Input DI2, Dig Input DI3, Dig Input DI4
	Select Dig Output	None, Dig Output D01, Dig Output D02, Dig Output D01 & D02
KW Demand Ckt 1 KW Demand Ckt 2 KW Demand Ckt 3	Pickup Setpoint	Kilowatts
	Pickup Time Delay	Seconds
	Dropout Setpoint	Kilowatts
	Dropout Time Delay	Seconds
	Enable	Disable (default) or enable
	Priority	None (default), medium, low <sup>2</sup>
	Select Dig Output	None, Dig Output D01, Dig Output D02, Dig Output D01 & D02
KW Ckt 1 KW Ckt 2 KW Ckt 3	Pickup Setpoint	Kilowatts
	Pickup Time Delay	Seconds
	Dropout Setpoint	Kilowatts
	Dropout Time Delay	Seconds
	Enable	Disable (default) or enable
	Priority	None (default), medium, low <sup>2</sup>
	Select Dig Output	None, Dig Output D01, Dig Output D02, Dig Output D01 & D02

<sup>1</sup> For multi-level alarms, pickup and dropout values cannot overlap:  
0 < Low Low PU < Low Low DO < Low PU < Low DO < High DO < High PU < High High DO < High High PU < 200%

<sup>2</sup> Multi Circuit mode does not support high priority alarms.

## Setting Up Multi Circuit Alarms

### **⚠ WARNING**

#### **HAZARD OF UNDELIVERED NOTIFICATIONS**

Do not rely solely on the power meter for alarm notifications where human or equipment safety relies on successfully delivered notifications.

**Failure to follow these instructions can result in death, serious injury, or equipment damage.**

Follow the steps in “Alarm Setup” on page 42 to reach the alarm setup screen.

To set up multi circuit alarms:

1. Press [Multi]. The multi circuit alarm Select screen appears.
2. Press ▼ and ▲ to scroll through the list of multi circuit alarms.
3. Press [Edit] to select an alarm to be configured. For MultiLevel I alarms, follow steps 4 to 21. For KW Demand and KW alarms, skip to step 21.
4. Press [Edit] to select Breaker Rating.
5. Press + to increment the active digit through the numerals 0-9.
6. Press ◀ to enter the selected value for the active digit and move to the next digit to the left.
7. Continue until all values are selected, then press [OK] to enter the breaker rating.
8. For pickup and dropout items (High High PU%, High High DO%, High PU%, High DO%, Low PU%, Low DO%, Low Low PU%, Low Low DO%), press ▼ to select the item, then press [Edit].
9. Follow steps 5 to 7 to set pickup and drop out values.  
**NOTE:** Values up to 200% of the breaker rating are allowed.
10. Press ▼ and follow Steps 5 to 7 for Pickup Time Delay (s).

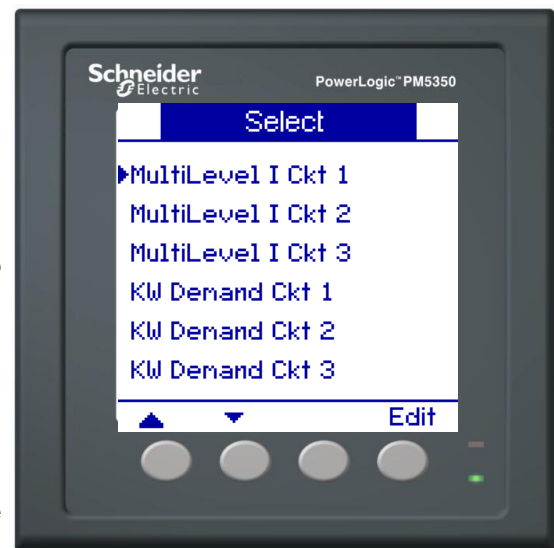

## Setting Up Multi Circuit Alarms (continued)

11. Press ▼ to select Enable, then press [Edit].
12. Press + and - to scroll between Yes and No.
13. Press [OK] to enable or disable the alarm.
14. Press ▼ to select Priority, then press [Edit].
15. Press + and - to scroll through priority options None, Medium, or Low.  
**NOTE:** Multi circuit alarms do not use the High priority level. See “Alarm Priorities” on page 41 for more information.
16. Press ▼ to select Select Dig Input, then press [Edit].
17. Press + and - to scroll through the list of digital inputs to associate with the alarm.
18. Press [OK] to select a digital input to be associated with the selected alarm.
19. Press ▼ to select Select Dig Output, then press [Edit]. Follow steps 16 to 18 for Select Dig Output.
20. Press ▲ to save all alarm selections and return to the previous screen.

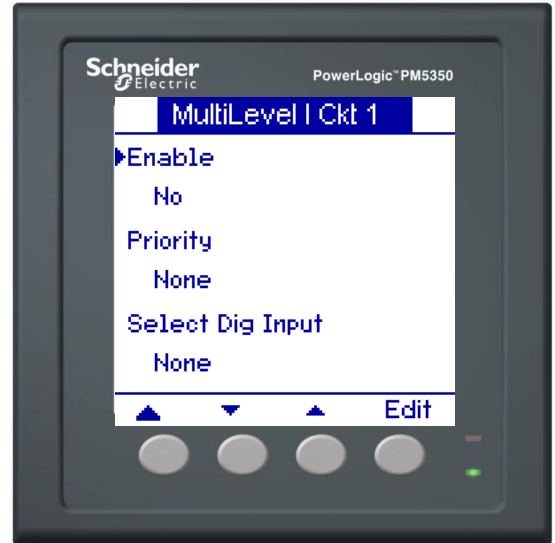

## Setting Up Multi Circuit Alarms (continued)

21. For KW Demand and KW alarms, press [Edit] to select Pickup Setpoint.
22. Press + to increment the active digit through the numerals 0-9.
23. Press ◀ to enter the selected value for the active digit and move to the next digit to the left.
24. Continue until all values are selected, then press [OK] to enter the pickup setpoint.
25. Press ▼ and follow Steps 22 to 24 for Pickup Time Delay (s), Dropout Setpoint, and Dropout Time Delay,
26. Press ▼ and follow Steps 11 to 19 for Enable, Priority, Select Dig Output.
27. Press ▲ to save all alarm selections and return to the previous screen.

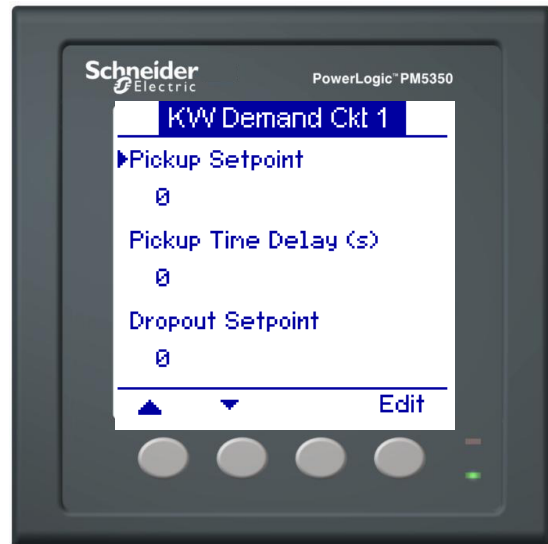



## Viewing Multi Circuit Alarm Activity and History

The power meter displays any active alarm whether it is in Normal or Multi Circuit mode. See “Viewing Alarm Activity and History” on page 48 for information on viewing active alarms, alarm history, and alarm counters. Multi circuit alarms do not appear in the unacknowledged alarms list.

### Multi Circuit Event Types

The Event parameter is Pickup or Dropout except for multi-level alarms.

**Table E-5: Events by Alarm Type**

Alarm Type	Event
Multi Level I Ckt 1 Multi Level I Ckt 2 Multi Level I Ckt 3	HH Pickup
	HH Dropout
	H Pickup
	H Dropout
	L Pickup
	L Dropout
	LL Pickup
	LL Dropout
	Tripped
	<b>NOTE:</b> Other multi-level alarm types are suppressed when the event type is Tripped.
KW Demand Ckt 1	Pickup
KW Demand Ckt 2	Dropout
KW Demand Ckt 3	
KW Ckt 1	Pickup
KW Ckt 2	Dropout
KW Ckt 3	

## Multi Circuit Alarm on Phase

The Phase parameter shows the phase on which the alarm event occurred.

**Table E-6: Multi Circuit Alarm on Phase by Power System Type**

Alarm Type	MULTI-3CKT-LN	MULTI-2CKT-LL (AB_BC)	MULTI-2CKT-LL (BC_CA)	MULTI-2CKT-LL (AB_CA)	MULTI-CKT-WYE
MultiLevel I Ckt 1	A	A	B	A	A, B, C (Any or all)
MultiLevel I Ckt 2	B	B	C	C	
MultiLevel I Ckt 3	C				
KW Demand Ckt 1	A	A	B	A	A, B, C (Any or all)
KW Demand Ckt 2	B	B	C	C	
KW Demand Ckt 3	C				
KW Ckt 1	A	A	B	A	A, B, C (Any or all)
KW Ckt 2	B	B	C	C	
KW Ckt 3	C				

## Multi Circuit Alarm Values

The Value field shows the alarm trigger point. For multi-level alarms, the value is in amps. For KW and KW Demand alarms, it is the pickup or dropout value.

## Command Interface with Multi-Level Alarms

See “Command Interface” on page 73 for information on using the command interface.

The command number and parameters for Multi-Level Alarm Setup are available in the register list. For information on accessing the register list, see “Register List” on page 64.

## Quick Read Block for Modbus Reads

The Quick Read block is a block of registers mirrored from the standard register map that allows basic meter values to be gathered with a single Modbus block read. This information can be found in the Application Specific Registers > Meter Data (Quick Read) category of the register list. For information on accessing the register list, see “Register List” on page 64.

## Input/Output Capabilities

### Monitoring for Tripped Status with a Digital Input

## ⚠ WARNING

**UNINTENDED EQUIPMENT OPERATION**

- Do not use this device for critical control or protection applications where human or equipment safety relies on the operation of the control action.
- Do not rely solely on device data to determine if your power system is functioning correctly or meeting all applicable standards and compliances.
- Do not use device control for time-critical functions because delays can occur between the time a control action is initiated and when that action is applied.
- Do not use digital inputs for voltage sensing applications over 36 Vdc.

**Failure to follow these instructions can result in death, serious injury, or equipment damage.**

You can monitor the tripped status of a circuit breaker with a multi-level alarm by wiring the circuit breaker auxiliary contact to a digital input on the power meter (Figure E-5). KW and KW Demand alarms cannot be associated with the tripped condition.

Digital inputs are event-driven. The power meter only registers a circuit breaker trip when there is an Off-to-On transition. A Tripped alarm event is triggered through a contact closure and not through detection of zero current.

**Figure E-5: Wiring a Circuit Breaker Auxiliary Contact to the Power Meter**

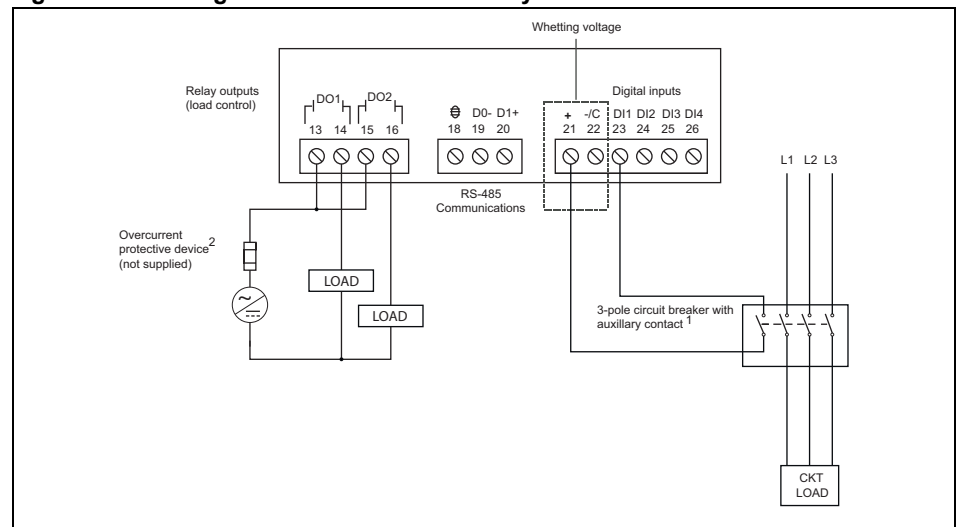

<sup>1</sup> Circuit breaker will be 1-, 2-, or 3-pole depending on your power system configuration.

<sup>2</sup> The overcurrent protective device must be rated for the short-circuit current at the connection point.

To set up a multi-level alarm to monitor for circuit breaker tripped status:

1. Follow the steps for setting up a multi-level alarm in “Setting Up Multi Circuit Alarms” on page 86.
2. For Select Dig Input, select the input that is wired to the circuit breaker auxiliary contact.

**NOTE:** If the selected digital input is set to operate in Demand Sync mode, the input’s association with a multi-level alarm will override this setting. The digital input will return to Demand Sync mode when association with the multi-level alarm is removed. See “Setting Up the Digital Inputs” on page 52 for more information on input control modes.

3. Press ▲ to save all alarm selections and return to the previous screen.

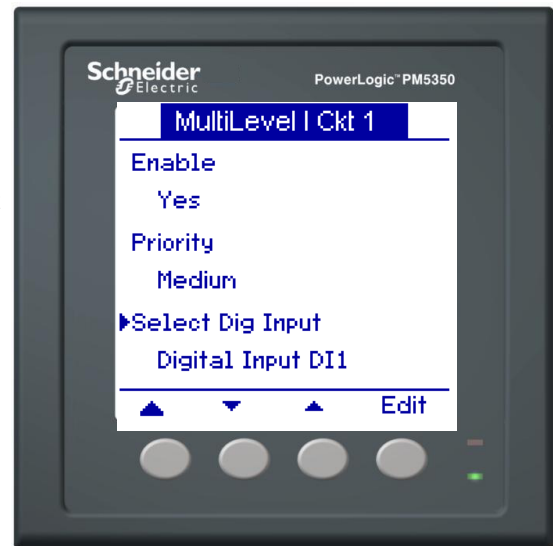

## Digital Outputs in Multi Circuit Mode

Digital outputs can be associated with all types of multi circuit alarms. See “Digital Outputs” on page 55 for information on configuring digital outputs.

## LEDs

See “Setting Up the Energy/Alarm LED” on page 60 to reach the LED setup screen.

Available multi circuit LED modes are described below.

- **Energy**—Flashes at a rate proportional to the total amount of energy consumed. Per circuit values are not selectable options for LED output.
- **Alarm**—If the LED is configured to flash on alarms, it will not flash on multi circuit alarms because these alarms will not have a priority of High. The LED will flash for any configured non-multi-circuit alarms.
- **Off**—Turns off the LED.

# Glossary

## Terms

**accumulated energy**—energy accumulates as either delivered to the customer or received from the customer.

**active alarm**—an alarm that has been set up to trigger the execution of a task or notification when certain conditions are met. An icon in the upper-right corner of the power meter indicates that an alarm is active (!).

**ASCII**—American Standard Code for Information Interchange

**baud rate**—specifies how fast data is transmitted across a network port.

**block interval demand**—demand calculation method for a block of time; includes sliding block, fixed block, or rolling block method.

**communications link**—a chain of devices connected by a communications cable to a communications port.

**current transformer (CT)**—current transformer for current inputs.

**debounce time**—amount of time an input must be consistently on before the transition is accepted as valid.

**demand**—average value of a quantity, such as power, over a specified interval of time.

**device address**—used to identify a device on the Modbus communications link; defines where the power meter resides in the power monitoring system.

**energy delivered**—the utility delivers energy to the facility; energy in.

**energy received**—the utility receives energy from the facility; the customer provides power to the utility; energy out.

**event**—the occurrence of an alarm condition, such as *Undervoltage Phase A*, configured in the power meter.

**firmware**—operating system within the power meter.

**fixed block**—a demand calculation method using an interval selected from 1 to 60 minutes (in 1-minute increments). The power meter calculates and updates the demand at the end of each interval.

**frequency**—number of cycles in one second.

**GMT**—Greenwich Mean Time

**lagging current (I)**—current is lagging voltage up to 180°.

**leading current (I)**—current is leading voltage up to 180°.

**lagging power factor (PF)** —active and reactive power flowing in the same directions.

**leading power factor (PF)** —active and reactive power flowing in opposite directions.

**line-to-line voltages**—measurement of the rms line-to-line voltages of the circuit.

**line-to-neutral voltages**—measurement of the rms line-to-neutral voltages of the circuit.

**maximum value**—highest value recorded of the instantaneous quantity such as Phase A Current, Phase A Voltage, etc., since the last reset of the minimums and maximums.

**minimum value**—lowest value recorded of the instantaneous quantity such as Phase A Current, Phase A Voltage, etc., since the last reset of the minimums and maximums.

**multi circuit**—ability to meter multiple circuits with a single metering device.

**nominal**—typical or average.

**parity**—refers to binary numbers sent over the communications link. An extra bit is added so that the number of ones in the binary number is either even or odd, depending on your configuration. Used to detect errors in the transmission of data.

**partial interval demand**—equal to energy accumulated thus far in the interval divided by the length of the complete interval.

**peak demand current**—highest demand current measured in amperes since the last reset of demand.

**peak demand real power**—highest demand real power measured since the last reset of demand.

**peak demand**—highest demand measured since the last reset of demand.

**phase currents (rms)**—measurement in amperes of the rms current for each of the three phases of the circuit.

**phase rotation**—refers to the order in which the instantaneous values of the voltages or currents of the system reach their maximum positive values. Two phase rotations are possible: A-B-C or A-C-B.

**potential transformer (PT)**—also known as a voltage transformer (VT).

**power factor (PF)**—power factor is the degree to which voltage and current to a load are out of phase. Total power factor is the difference between the total power your utility delivers and the portion of total power that does useful work. True power factor is the ratio of real power to apparent power using the complete harmonic content of real and apparent power. Calculated by dividing watts by volt amperes. Displacement power factor is the cosine of the angle between the fundamental components of current and voltage, which represents the time lag between fundamental voltage and current.

**real power**—calculation of the real power (3-phase total and per-phase real power calculated) to obtain kilowatts.

**rms**—root mean square. Power meters are true rms sensing devices.

**rolling block**—a selected interval and subinterval that the power meter uses for demand calculation. The subinterval must divide evenly into the interval. Demand is updated at each subinterval, and the power meter displays the demand value for the last completed interval.

**sliding block**—an interval selected from 1 to 60 minutes (in 1-minute increments). If the interval is between 1 and 15 minutes, the demand calculation updates every 15 seconds. If the interval is between 16 and 60 minutes, the demand calculation updates every 60 seconds. The power meter displays the demand value for the last completed interval.

**thermal demand**—demand calculation based on thermal response.

**Total Demand Distortion (TDD)**—indicates the harmonic currents between an end user and a power source.

**Total Harmonic Distortion (THD or thd)**—indicates the degree to which the voltage or current signal is distorted in a circuit.

**total power factor**—see *power factor*.

**true power factor**—see *power factor*.

**unary alarm**—an alarm based on singular events or specific conditions for which setpoints are not appropriate.

**voltage transformer (VT)**—also known as a potential transformer (PT).

## Abbreviations

<b>A</b>	—Ampere
<b>Amps</b>	—Amperes
<b>CKT</b>	—Circuit
<b>CPT</b>	—Control Power Transformer
<b>CT</b>	—Current Transformer
<b>D In</b>	—Digital Input
<b>D Out</b>	—Digital Output
<b>DMD</b>	—Demand
<b>DO</b>	—Drop Out
<b>F</b>	—Frequency
<b>GMT</b>	—Greenwich Mean Time
<b>Hz</b>	—Hertz
<b>I</b>	—Current
<b>I/O</b>	—Input/Output
<b>I<sub>max</sub></b>	—Current maximum demand
<b>kVA</b>	—Kilovolt-Ampere
<b>kVAD</b>	—Kilovolt-Ampere demand
<b>kVAR</b>	—Kilovolt-Ampere reactive
<b>kVAR<sub>D</sub></b>	—Kilovolt-Ampere reactive demand
<b>kVAR<sub>H</sub></b>	—Kilovolt-Ampere reactive hour
<b>kW</b>	—Kilowatt
<b>kWD</b>	—Kilowatt demand
<b>kWH</b>	—Kilowatthours
<b>kWH/P</b>	—Kilowatthours per pulse
<b>kW<sub>max</sub></b>	—Kilowatt maximum demand
<b>Mag</b>	—Magnitude
<b>Maint</b>	—Maintenance
<b>Min</b>	—Minimum
<b>MnMx</b>	—Minimum and maximum values
<b>MSec</b>	—Milliseconds
<b>MVAh</b>	—Megavolt ampere hour
<b>MVARh</b>	—Megavolt ampere reactive hour
<b>MWh</b>	—Megawatt hour
<b>OS</b>	—Operating System (firmware version)
<b>P</b>	—Real power
<b>P<sub>d</sub></b>	—Real power demand
<b>PF</b>	—Power factor
<b>PM</b>	—Power meter
<b>PQS</b>	—Real, reactive, apparent power
<b>PQS<sub>d</sub></b>	—Real, reactive, apparent power demand
<b>Prim</b>	—Primary
<b>PT</b>	—Potential Transformer (also known as VT—Voltage Transformer)
<b>PU</b>	—Pick Up
<b>Pulse</b>	—Pulse output mode

**Pwr**—Power  
**Q**—Reactive power  
**Qd**—Reactive power demand  
**RS**—Firmware reset system version  
**S**—Apparent power  
**SN**—Power meter serial number  
**Sd**—Apparent power demand  
**Sec**—Secondary  
**Sub-I**—Subinterval  
**TDD**—Total Demand Distortion  
**THD**—Total Harmonic Distortion  
**U**—Voltage line to line  
**V**—Volts  
**VT**—Voltage Transformer (also known as PT—Potential Transformer)  
**VAR**—Volt ampere reactive  
**Vmax**—Maximum voltage  
**Vmin**—Minimum voltage



# Index

## A

- alarm
  - icon 42
  - LED 41
- alarm LED 7, 39
- alarms 39
  - digital 41
    - setup 46
  - icon 5, 39
  - LED 39
  - list of standard over/under 40
  - multi circuit 85
  - priorities 41
  - setup 42
    - digital 46
    - multi circuit 86, 87
    - standard over/under 43
    - unary 45
  - standard over/under 40
    - setup 43
  - unary 41
    - setup 45
  - viewing activity 48
  - viewing history 48
    - multi circuit 89

## B

- block interval demand method 32

## C

- command interface 73
  - protected 74
  - unprotected 75
- communication LED 7
- communications
  - setup 20

## CT

- setup 13
- multi circuit 82

## D

- demand
  - predicted 35
  - setup 17
  - thermal 35
- demand power calculation 32
- demand readings 32
  - demand power calculation methods 32
  - peak demand 36
  - predicted demand 35
- digital alarms
  - setup 46
- digital input 51
  - operating modes 51
  - setup 52
- digital inputs
  - receiving a synch pulse 34

- digital output 55
  - behavior 55
  - control mode 55
  - setup 56
- display
  - menu overview 9
  - operating 5
  - setup 21, 22

## E

- energy LED 7
- energy readings 36

## F

- firmware 2
- fixed block 32

## H

- heartbeat icon 5
- heartbeat LED 7
- HMI
  - setup 21

## I

- icon 5
  - alarm 5, 39, 42
  - heartbeat 5
  - maintenance 5, 64
- incremental energy
  - interval 36
- input synchronized demand 34
- inputs
  - accepting pulse from another meter 34
  - multi circuit 91

## L

- LED 7, 41
  - alarm 7, 39, 60
  - communication 7, 63
  - energy 7, 60
  - heartbeat 7, 63
  - multi circuit 92

## M

- maintenance icon 5, 64
- memory
  - power meter memory 61
- menu 9, 79
- metered values
  - demand readings 32
  - energy readings 36
  - real-time readings 29
- min/max
  - power factor conventions 31
  - real-time readings 30
- multi circuit
  - alarm activity 89
  - alarms 85
    - event types 89
    - phase 90
    - setup 86, 87
    - value 90

- characteristics 84
- command interface 90
- CT options 82
- demand readings 84
- LED 92
- menu 79
- metering 84
- outputs 92
- overview 77
- power systems 80
- quick read block 90
- setup 77
- tripped status 91
- voltage connection 82

## P

- password
  - default 10
  - recovery 61
- peak demand calculation 36
- power analysis values 37
- power factor 31, 71
  - min/max conventions 31
  - register format 71
- power meter
  - accessories 2
  - advanced setup 16
  - basic setup 10
  - box contents 2
  - characteristics 29
    - multi circuit 84
  - clock setup 24
  - communication setup 20
  - demand setup 17
  - firmware 2
  - hardware 1
  - HMI setup 21
  - memory 61
  - reset 25
  - specifications 65
- predicted demand calculation 35

## R

- readings
  - demand 32
- real-time readings 29
  - min/max values 30
- reset
  - global 26
  - of peak demand values 36
  - single 27
- rolling block 33
- RS-485 30

## S

- semaphore 74
- setup
  - alarms 48
  - circuit mode 80
  - communications 20
  - CT 14, 82
    - multi circuit 82
  - demand 17

- digital input 52
- digital output 56
- display 21, 22
- load timer setpoint 16
- passwords 24
- peak current demand 17
- power system 10
  - multi circuit 80
- regional settings 23
- voltage connection 13
  - multi circuit 82
- sliding block 32
- standard over/under alarms
  - setup 42
- synchronized demand
  - input 34

## T

- TDD 37
- technical support 64
- THD 37
- thd 37
- thermal demand method 35
- troubleshooting 63

## U

- unary alarms
  - setup 45

## W

- wiring
  - troubleshooting 64

## China Standard Compliance

This product complies with the following standard(s) in China:

IEC 62053-22:2003 Electricity metering equipment (a.c.) - Particular Requirements - Part 22: Static meters for active energy (classes 0,2 S and 0,5 S)

IEC 61557-12:2007 Electrical safety in low voltage distribution systems up to 1 000 V a.c. and 1 500 V d.c. - Equipment for testing, measuring or monitoring of protective measures - Part 12: Performance measuring and monitoring devices

GB/T 22264.7-2008 安装式数字显示电测量仪表 第7部分：多功能仪表的特殊要求





PowerLogic and Schneider Electric are trademarks or registered trademarks of Schneider Electric in France, the USA and other countries. Other trademarks are the property of their respective owners.

- This product must be installed, connected and used in compliance with prevailing standards and/or installation regulations.
- If this product is used in a manner not specified by the manufacturer, the protection provided by the product may be impaired.
- The safety of any system incorporating this product is the responsibility of the assembler/installer of the system.

As standards, specifications and designs change from time to time, always ask for confirmation of the information given in this publication.