



# **XD/XL series PLC**

**User manual [positioning control]**

Wuxi XINJE Electric Co., Ltd.

Data no. PD02 20170518 3.4

	Preface	
	<hr/>	
XD/XL series PLC	Pulse output	1
User manual	<hr/>	
[Positioning control]	Motion control	2
	<hr/>	
	Application	3
	<hr/>	
	Appendix	
	<hr/>	

## Version 1

- Basic explanation

Thank you for purchasing Xinje XD/XL series PLC.

This manual mainly introduces XD/XL series PLC instructions.

Please read this manual carefully before using and wire after understanding the content.

About software and programming instructions, please refer to related manuals.

Please hand this manual over to operation users.

- Notices for users

Only experienced operator can wire the plc. If any problem, please contact our technical department.

The listed examples are used to help users to understand, so it may not act.

Please confirm that PLC specifications and principles are suitable when connect PLC to other products. Please conform safety of PLC and machines by yourself when use the PLC. Machines may be damaged by PLC errors.

- Responsibility declaration

The manual content has been checked carefully, however, mistakes may happen.

We often check the manual and will correct the problems in subsequent version. Welcome to offer advices to us.

Excuse us that we will not inform you if manual is changed.

- Contact information

If you have any problem about products, please contact the agent or Xinje company.

Tel: 0086 510-85134136 85123803

Fax: 0086 510-85111290

Address: Building 7 fourth floor, No.100, Dicui Rd, Wuxi, China.

Code: 214072

### **WUXI XINJE ELECTRIC CO., LTD. Copyrights**

Do not copy or use manual without written permission. Offenders should be responsible for losses. Please keep all copyrights of our company including practical modules, designed patents and copyrights mentioned in register.

**2015, 5, 12**

---

# Catalog

<b>PREFACE</b> .....	<b>3</b>
<b>1 PULSE OUTPUT</b> .....	<b>6</b>
1-1. FUNCTION OVERVIEW .....	7
1-2. PULSE OUTPUT TYPE AND INSTRUCTION APPLICATION.....	9
1-2-1. Pulse parameter and configuration.....	9
1-2-2. Multi-segment pulse output [PLSR] .....	65
1-2-3. Variable frequency pulse output [PLSF] .....	107
1-2-4. Relative single segment positioning [DRVI].....	120
1-2-5. Absolute single-segment positioning [DRVA].....	127
1-2-6. Mechanical origin return[ZRN] .....	134
1-2-7. Pulse stop [STOP] .....	173
1-2-8. Pulse continue [GOON] .....	174
1-3. PULSE PARAMETER CONFIGURATION WIZARD.....	177
1-3-1. Pulse Parameter Configuration Wizard Opening Mode.....	177
1-3-2. Instructions for the Use of the Pulse Parameter Config guide.....	179
1-4. OUTPUT WIRING AND NOTES .....	187
1-4-1. Composition of Connecting Equipment .....	188
1-4-2. Pulse output performance specification .....	192
1-4-3. Positioning control layout and wiring notes.....	193
1-4-4. Setting of Servo Amplifier (Driving Unit) Side .....	195
1-4-5. Pulse sending complete flag notes .....	199
1-4-6. Cautions for triggering conditions of positioning instructions.....	201
1-4-7. Positioning Instruction and System Parameter Block Related Parameters.....	201
1-4-8. Troubleshooting of Servo Motor and Stepping Motor .....	203
1-4-9. Troubleshooting of incorrect stop position of servo motor and stepper motor .....	205
1-5. POSITIONING INSTRUCTION EXAMPLE PROGRAMS.....	206
1-5-1. I/O point assignment.....	206
1-5-2. Forward and reverse rotation sequence control sample program .....	207
1-5-3. Forward and reverse rotation process program .....	217
1-5-4. Forward and reverse rotation multi-section process program .....	230
1-5-5. Forward reverse multi-segment process program 【PLSF, PLSR, ZRN】 .....	244
1-5-6. Forward reverse rotation multi-segment sequential control program .....	262
1-5-7. Forward and reverse rotation multi-segment process program.....	276
1-6. PULSE OUTPUT COIL AND REGISTER.....	292
<b>2 MOTION CONTROL</b> .....	<b>310</b>
2-1. MOTION CONTROL INSTRUCTION LIST.....	310
2-2. WRITING METHOD OF MOTION CONTROL INSTRUCTION .....	311
2-3. PULSE OUTPUT TERMINAL DISTRIBUTION AND PARAMETERS .....	315
2-3-1. Pulse output port distribution.....	315
2-3-2. Pulse output terminal parameters .....	315

---

2-4. MOTION CONTROL INSTRUCTION .....	318
2-4-1. Quick positioning [DRV] .....	318
2-4-2. Quick positioning (polar coordinates) [DRVR] .....	328
2-4-3. Linear interpolation [LIN] .....	331
2-4-4. Clockwise arc [CW] .....	346
2-4-5. Anticlockwise arc [CCW] .....	362
2-4-6. Clockwise arc [CW_R] .....	379
2-4-7. Anticlockwise arc [CCW_R] .....	395
2-4-8. Three points arc [ARC] .....	410
2-4-9. Follow [FOLLOW] [FOLLOW_AB] .....	425
2-5. HARDWARE WIRING AND PRECAUTIONS .....	430
2-5-1. Input wiring .....	430
2-5-2. Output wiring .....	434
2-6. EXAMPLES .....	436
2-6-1. Isosceles triangle .....	436
2-6-2. Circle + inscribed triangle .....	444
2-6-3. Line + Arc symmetric figure .....	452
2-6-4. Disorder line segments .....	458
<b>3 APPLICATION EXAMPLES .....</b>	<b>463</b>
3-1. APPLICATION OF PULSE OUTPUT .....	463
3-2. APPLICATION OF MOTION CONTROL IN ARC SAW MACHINING SYSTEM .....	471
3-3. APPLICATION OF MOTION CONTROL IN HAIR PLANTING MACHINE .....	474
<b>APPENDIX SPECIAL SOFT ELEMENT LIST .....</b>	<b>479</b>
APPENDIX 1. SPECIAL AUXILIARY RELAY .....	479
APPENDIX 2. SPECIAL DATA REGISTER LIST .....	489
APPENDIX 3. SPECIAL FLASH REGISTER LIST .....	505
APPENDIX 4. EXTERNAL INTERRUPTION TERMINAL LIST .....	544
APPENDIX 5. PLC RESOURCE CONFLICT TABLE .....	545

## Preface

———positioning control

This manual is XD/XL series PLC positioning control manual, it introduces pulse output and motion control function, is suitable for XD2, XD3, XD5, XDM, XDC, XD5E, XDME, XDH, XL3, XL5, XL5E, XLME series PLC (XD1 and XL1 have no positioning function).

### 1. XD/XL series PLC features:

#### ➤ **Faster instruction processing speed**

XD/XL series PLC instruction processing speed is 12~15 times faster than XC series, especially for the floating number instruction, the unit of scanning period is  $\mu\text{s}$ .

#### ➤ **Up to 10 to 16 modules and 2 BD cards, 1 ED module can be extended**

Similar to XC series PLC, XD3, XD5, XDM, XDC, XD5E series PLC also support extension module and BD card (XD1/XD2 cannot extend module and BD card, XDH cannot extend ED and BD), including digital, analog, temperature module. The extension modules can be 10 or 16, BD card 1 or 2.

XL series PLC can support 10 right extension modules, 1 left extension ED module.

#### ➤ **Compatible with most functions of XC series**

XD/XL series PLC support most basic functions of XC series PLC.

#### ➤ **Compatible with XC series program**

XD/XL series PLC software XDPPro can open the program of XC series PLC, but some different instructions will be shown in red colors, user only needs to modify this part of program.

#### ➤ **XL has compact size**

XL series PLC is card type PLC, with a thinner and smaller appearance, which can greatly save the installation space.

#### ➤ **X-NET fieldbus**

XD/XL PLC supports xnet fieldbus communication, which can realize fast and stable communication to XD/XL PLC and TG/TN touch screen. XDC series PLC supports the function of x-net motion bus and can control 20-axis synchronous motion.

#### ➤ **Ethernet communication**

Ethernet PLC has RJ45 port and supports TCP/IP protocol. It can realize MODBUS-TCP communication and free format communication based on Ethernet. Supports program download, online monitoring, remote monitoring, and communication with other TCP/IP devices.

#### ➤ **EtherCAT bus**

XDH series PLC supports EtherCAT bus function, and can control 32 axes synchronously, with synchronization period  $\leq 1\text{ms}$ .

## 2. Product models

### XD1 series models:

- XD1-16R/T-E/C
- XD1-32R/T-E/C

### XD2 series models:

- XD2-16R/T-E/C
- XD2-24R/T/RT-E/C
- XD2-32R/T/RT-E/C
- XD2-48R/T/RT-E/C
- XD2-60R/T/RT-E/C

### XD3 series models:

- XD3-16R/T/RT-E/C, XD3-16PT-E/C
- XD3-24R/T/RT-E/C, XD3-24PR/T/RT-E/C
- XD3-32R/T/RT-E/C, XD3-32PR/T/RT-E/C
- XD3-48R/T/RT-E/C, XD3-48PT-E/C
- XD3-60R/T/RT-E/C, XD3-60PT-E/C

### XD5 series models:

- XD5-16R/T-E/C
- XD5-24R/T/RT-E/C, XD5-24T4-E/C
- XD5-32R/T/RT-E/C, XD5-32T4-E/C
- XD5-48R/T/RT-E/C
- XD5-60R/T/RT-E/C
- XD5-48T4-E/C
- XD5-48T6-E/C
- XD5-60T4-E/C
- XD5-60T6-E/C
- XD5-60T10-E/C

### XDM series models:

- XDM-24T4-E/C, XDM-24PT4-E/C
- XDM-32T4-E/C, XDM-32PT4-E/C
- XDM-60T4-E/C
- XDM-60T10-E/C, XDM-60PT10-E/C
- XDM-60T4L-E

### XDC series models:

- XDC-24T-E/C
- XDC-32T-E/C
- XDC-48T-E/C
- XDC-60T-E/C

### XD5E series models:

- XD5E-30T4-E
- XD5E-60T10-E

XDME series models:

- XDME-60T10-E

XDH series models:

- XDH-60T4-E

### 3. XL series PLC

XL1 series PLC:

- XL1-16T, XL1-16T-U

XL3 series PLC:

- XL3-16R/T, XL3-16PR, XL3-32T

XL5 series PLC:

- XL5-16T, XL5-32T, XL5-32T4

XL5E series PLC:

- XL5E-16T, XL5E-32T, XL5E-32T4, XL5E-64T6

XLME series PLC:

- XLME-32T4

### 4. Version requirements

XD series PLC: XDPpro software v3.2 and up.







XL series PLC: XDPpro software v3.5 and up.

Part of the instructions have version requirements, please refer to the instruction details.



# 1 Pulse output

Pulse output instruction list:

instruction	function	Instruction writing format	chapter
<b>Pulse output</b>			
PLSR	Multi-segment pulse output	 PLSR S0 S1 S2 D	1-2-2
PLSF	Variable frequency pulse output	 PLSF S0 S1 D	1-2-3
DRVI	Relative single segment positioning	 DRVI S0 S1 S2 D1 D2	1-2-4
DRVA	Absolute single segment positioning	 DRVI S0 S1 S2 D1 D2	1-2-5
ZRN	Mechanical return zero	 ZRN S0 D	1-2-6
STOP	Stop pulse	 STOP S0 S1	1-2-7
GOON	Continue to output pulse	 GOON Yn	1-2-8

## 1-1. Function overview

XD2, XD3, XD5 (except XD5-48T6/60T6), XDC, XL3 series PLC have 2 channels of pulse output. XD5-48T6/60T6, XDM, XD5E series PLC have 4~10 channels of pulse output. The different pulse functions include single direction pulse output with or without acceleration/deceleration, multi-segment double direction pulse output. The max output frequency can up to 100KHz.

**Note:** as XC series PLC cannot write two or more pulse output instructions for same terminal in main program or process. But XD series PLC has no problem cause its condition is edge-triggered.

### Pulse output terminal:

PLC model	Pulse channels	Pulse output terminal	output frequency	Output mode	Output format
XD2-16T/RT XD2-24T/RT XD2-32T/RT XD2-48T/RT XD2-60T/RT	2	Y0, Y1	0~100KHz	Open collector	Pulse+direction
XD3-16T/RT XD3-24T/RT XD3-32T/RT XD3-48T/RT XD3-60T/RT	2	Y0, Y1	0~100KHz	Open collector	Pulse+direction
XD5-16T/RT XD5-24T/RT XD5-32T/RT XD5-48T/RT XD5-60T/RT	2	Y0, Y1	0~100KHz	Open collector	Pulse+direction
XD5-24T4 XD5-32T4 XD5-48T4 XD5-60T4	4	Y0, Y1, Y2, Y3	0~100KHz	Open collector	Pulse+direction
XD5-48T6 XD5-60T6	6	Y0, Y1, Y2, Y3, Y4, Y5	0~100KHz	Open collector	Pulse+direction
XD5-48D4T4	8	Y0, Y2, Y4, Y6	0~920KHz	Differential	Pulse+direction
		Y0/Y1, Y2/Y3, Y4/Y5, Y6/Y7			AB phase
		Y10, Y12, Y14, Y16			Pulse+direction
XD5-60T10	10	Y0, Y1, Y2, Y3, Y4, Y5, Y6, Y7, Y10, Y11	0~100KHz	Open collector	Pulse+direction
XDM-24T4 XDM-32T4 XDM-60T4	4	Y0, Y1, Y2, Y3	0~100KHz	Open collector	Pulse+direction

XDM-60T4L					
XDM-60T10	10	Y0, Y1, Y2, Y3, Y4, Y5, Y6, Y7, Y10, Y11	0~100KHz	Open collector	Pulse+direction
XDC-24T XDC-32T XDC-48T XDC-60T	2	Y0, Y1	0~100KHz	Open collector	Pulse+direction
XD5E-24/30/ 48/60T	2	Y0, Y1	0~100KHz	Open collector	Pulse+direction
XD5E-30/60T4	4	Y0, Y1, Y2, Y3	0~100KHz	Open collector	Pulse+direction
XD5E-60T6	6	Y0, Y1, Y2, Y3, Y4, Y5	0~100KHz	Open collector	Pulse+direction
XD5E-60T10	10	Y0, Y1, Y2, Y3, Y4, Y5, Y6, Y7, Y10, Y11	0~100KHz	Open collector	Pulse+direction
XDME-60T4	4	Y0, Y1, Y2, Y3	0~100KHz	Open collector	Pulse+direction
XDME-60T10	10	Y0, Y1, Y2, Y3, Y4, Y5, Y6, Y7, Y10, Y11	0~100KHz	Open collector	Pulse+direction
XDH-60T4	4	Y0, Y1, Y2, Y3	0~100KHz	Open collector	Pulse+direction
XL3-16/32T	2	Y0, Y1	0~100KHz	Open collector	Pulse+direction
XL5-16/32T	2	Y0, Y1	0~100KHz	Open collector	Pulse+direction
XL5-32T4	4	Y0, Y1, Y2, Y3	0~100KHz	Open collector	Pulse+direction
XL5E-16/32T	2	Y0, Y1	0~100KHz	Open collector	Pulse+direction
XL5E-32T4	4	Y0, Y1, Y2, Y3	0~100KHz	Open collector	Pulse+direction
XLME-32T4	4	Y0, Y1, Y2, Y3	0~100KHz	Open collector	Pulse+direction
XL5E-64T6	6	Y0, Y1, Y2, Y3, Y4, Y5	0~100KHz	Open collector	Pulse+direction

**Note:**

※1: all the pulse can output frequency 100~200KHz, but not all the servo can work well, please connect 500Ω resistor between output and 24V power supply.

※2: the direction terminal can be set to any terminal except pulse output terminal when using positioning instruction.

※3: pulse output terminal transistor response time is below 0.5μs, other transistors is below 0.2ms.

※4: the pulse output terminal can be used to pulse direction output when it has no pulse output.

※5: For differential pulse output, if pulse + direction mode is adopted, transistor or differential output terminal can be selected as direction terminal (differential output terminal +, - should be connected); if it is in AB phase mode, terminals must be used in pairs, such as Y0 and Y1. See the table above for specific distribution.

### Load current

Please make the open collector transistor output load current in the range of 10~100mA (DC5~24V) when the basic unit (transistor output type) pulse output terminal is used to pulse output or positioning instruction.

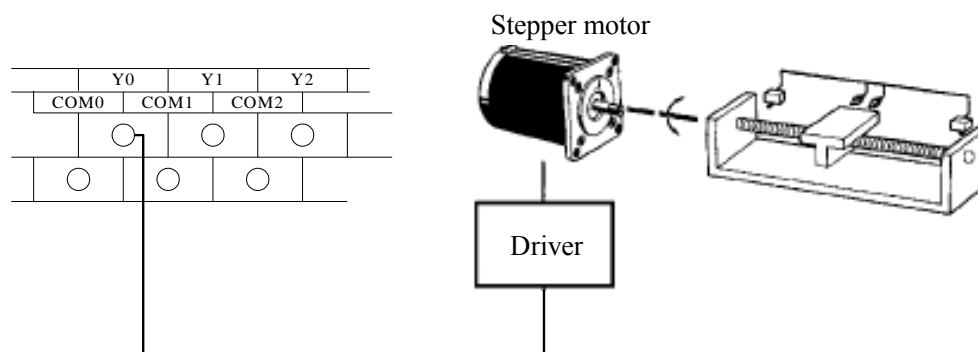

### Note:

- ※1: please use transistor terminal for pulse output. Such as XD3-16T-E or XD3-60T-E.
- ※2: it can choose any terminals for direction output except pulse output terminal.
- ※3: the pulse direction terminal will keep the state after the pulse output finished. if the state is ON, it will keep ON after pulse output finished. if the pulse output instruction does not have direction, user can control the direction terminal state by manual. If the pulse output instruction has direction, the instruction will automatically control the direction terminal.
- ※4: the pulse output terminal LED will slight light when the pulse is outputting. Because the pulse is 50% empty square wave, so the LED will light in half of the period and off in another half of period.
- ※5: the pulse output terminal Yn will be ON in software when the pulse is outputting, and it will be OFF when the pulse output finished.

## 1-2. Pulse output type and instruction application

### 1-2-1. Pulse parameter and configuration

XD/XL series PLC pulse output function needs to configure the pulse data, user parameters and system parameters. This chapter will introduce all the parameters and configuration methods.

Now we take PLSR instruction as an example.

PLSR instruction write format:

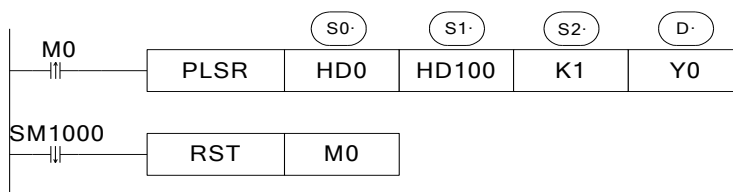

Click  in the software or right click the PLSR instruction in the program to open the configuration window of PLSR.

Configuration table:

Configuration item	Function
Data start address	Pulse data parameter address, occupied <b>【S0】 ~ 【S0+N*10+8】</b> (double words, N is pulse segment no.), store the pulse total segment number, pulse numbers, wait condition, register type and number, jump register type and number...
User parameter address	User parameter address, occupied <b>【S1】 ~ 【S1+2】</b> (double words), store the mode (relative/absolute), starting execute segment no.
System parameter	Choose which group of parameters, each pulse output terminal can set four group of parameters, the default is K1 (group 1)
Mode	Relative, absolute mode, default is relative mode
Start execute section count	PLSR executed from which segment, default is 0 (start from segment 1)
Config	Set the system parameters which are saved in special Flash register SFD900~SFD2193, it can set 4 groups of parameters of 10 pulse output terminals

### 1-2-1-1. Pulse data parameters (S0)

The pulse data parameters are set in the address starting from S0, please refer to the following table:

## ◆ Data starting address S0

Address	Contents	Remark
S0+0 (double words)	Pulse total segment number (1~100)	
S0+2 (8 words)	Reserved (8 words)	
S0+10 (double words)	Segment 1 pulse frequency	Segment 1
S0+12 (double words)	Segment 1 pulse number	
S0+14	High 8-bit: <b>【wait condition】</b> (set when to send the next segment of pulse) H00: pulse output finished (“H” means hex format) H01: wait time H02: wait signal H03: ACT time H04: EXT signal H05: EXT signal or pulse output finished	
	Low 8-bit: <b>【wait condition register type】</b> (use together with <b>【wait condition】</b> ) H00: constant H01: D H02: HD H03: FD H04: X H05: M H06: HM	
S0+15 (double words)	<b>【constant/register number (wait condition)】</b> , use together with <b>【wait condition】</b> , <b>【wait condition register type】</b>	
S0+17	Low 8-bit: <b>【jump register type】</b> (set the next pulse segment no.) H00: constant H01: D H02: HD H03: FD	
	<b>【constant/jump register number】</b> , use together with <b>【jump register type】</b>	
.....	.....	
S0+N*10+0 (double words)	Segment N pulse frequency	Segment N
S0+N*10+2 (double words)	Segment N pulse numbers	
S0+N*10+4	Wait condition, wait condition register type	
S0+N*10+5 (double words)	Constant or register number (wait condition)	
S0+N*10+7	Jump register type	
S0+N*10+8 (double words)	Constant or register number (jump register)	

**Note:**

※1: pulse frequency is positive value ( $\geq 0$ ), the value become larger is acceleration, become

smaller is deceleration, it is not related to the pulse direction.

※2: pulse numbers can be positive or negative value, negative value means reverse direction pulse.

■ **Wait condition (【S0+14】 high 8-bit)**

To set when to enter next segment of pulse.

● **Pulse sending finished (H00)**

Jump to the setting pulse segment after executing this segment of pulse.

**Example 1:**

When the pulse instruction PLSR is triggered, it will send segment 1 2000 pulses with the speed 1000Hz, and jump to segment 2 at once after segment 1 finished. Segment 2 is 4000 pulses with speed 2000Hz. Then it will jump to segment 3 at once after segment 2 finished. Segment 3 has 6000 pulses.

Configuration window:

multi section pulse output

data start address: HD0 user params address: HD100 system params: K1 output: Y0

mode: relative start execute section count: 0 Config

Add Delete Upwards Downwards

	frequence	pulse count	wait condition	wait register	jump register
1	1000	2000	pulse sending complete	K0	K0
2	2000	4000	pulse sending complete	K0	K0
▶ 3	3000	6000	pulse sending complete	K0	K0

used space: HD0-HD39,HD100-HD103

Read From PLC Write To PLC OK Cancel

**Multi-segment pulse configuration**

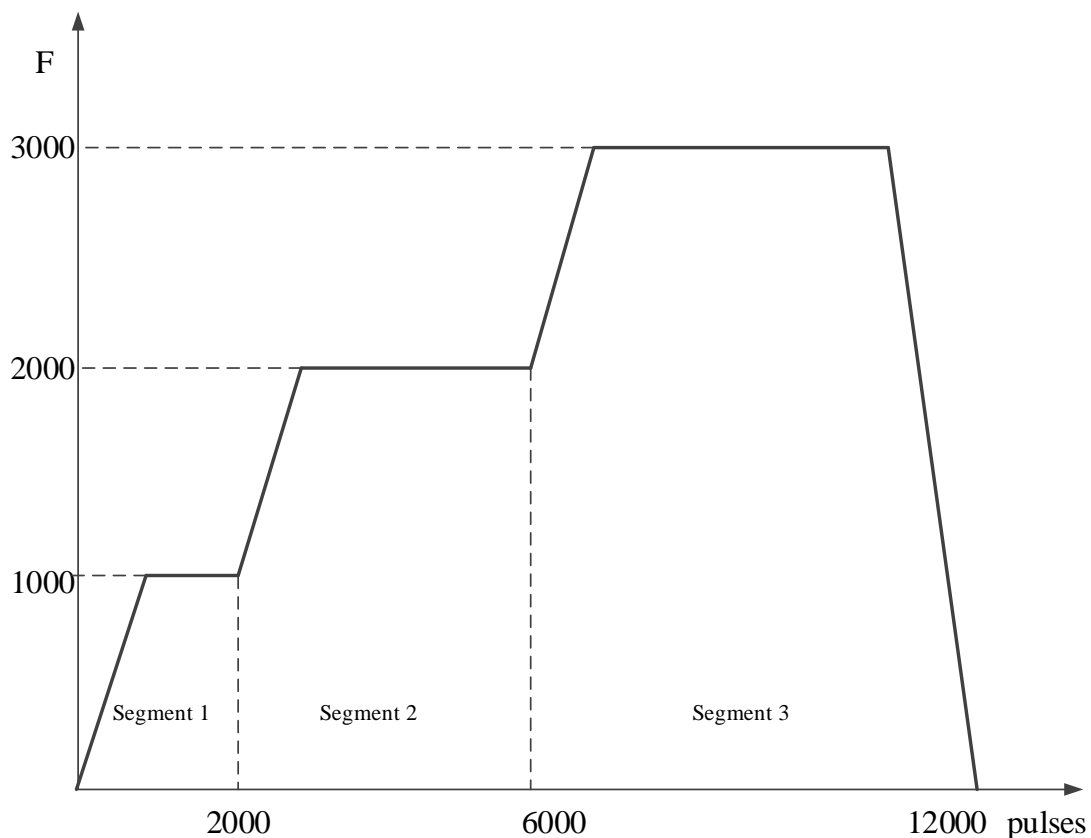

Multi-segment sequence control pulse wave

**Example 2:**

When the pulse instruction PLSR is triggered, it will send 2000 pulses with the speed 1000Hz, and jump to segment 3 to send 6000 pulses with the speed 3000Hz, then jump to segment 2 to send 4000 pulses, then jump to segment 3 to repeat the cycle.

The configuration window:

multi section pulse output

data start address: HD0 user params address: HD100 system params: K1 output: Y0

mode: relative start execute section count: 0 Config

Add Delete Upwards Downwards

	frequence	pulse count	wait condition	wait register	jump register
1	1000	2000	pulse sending complete	K0	K3
2	2000	4000	pulse sending complete	K0	K0
▶ 3	3000	6000	pulse sending complete	K0	K2

used space: HD0-HD39,HD100-HD103

Read From PLC Write To PLC OK Cancel

Multi-segment pulse output configuration table



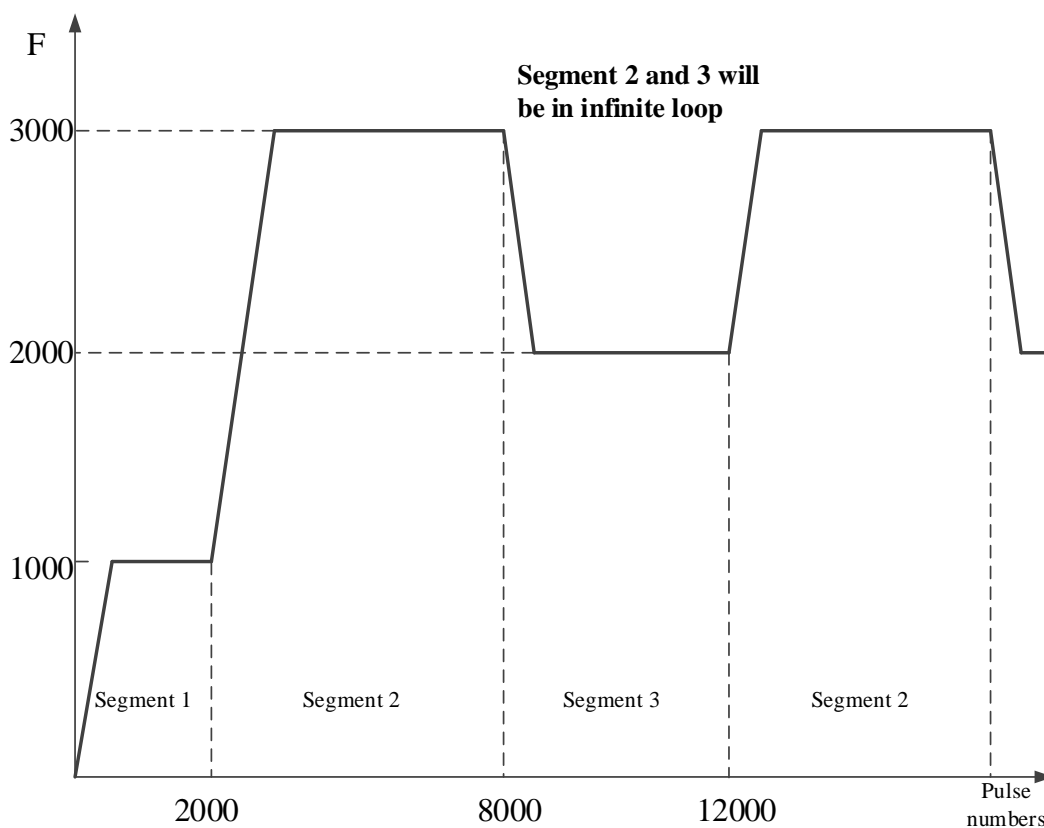

Multi-segment pulse sending diagram

**Note:**

※1: the acceleration deceleration time can be set in **【config】** list, all the parameter details are in **【config guide】**.

※2: **【jump register】** set to K0, it will jump to the next segment. If it is not 0, it will jump to corresponding segment. For example, K3 will jump to segment 3.

※3: when setting multi-segment of pulse, and **【jump register】** is set, endless pulse outputting loop should be avoided.

- **Wait time (H01)**

It starts to timing after present pulse segment end, it will jump to appointed segment when the time is up. The time can be constant or register D, HD, FD. The unit is ms.

**For example:**

When the relative mode pulse instruction PLSR is triggered, it sends 2000 pulses with the speed of 1000Hz, it will delay 200ms after segment 1 end then jump to segment 2. It sends 4000 pulses with the speed 2000Hz, it will delay the time of D100 (if D100=100, it will delay 100ms), then jump to segment 3 which will send 6000 pulses.

**Configurations:**

multi section pulse output ✖

data start address: HD0	user params address: HD100	system params: K1	output: Y0
mode: relative	start execute section count: 0	Config	

⋮ Add Delete | Upwards Downwards

	frequency	pulse count	wait condition	wait register	jump register
1	1000	2000	wait time	K200	K0
2	2000	4000	wait time	D100	K0
▶ 3	3000	6000	pulse sending complete	K0	K0

used space: HD0-HD39,HD100-HD103

Multi-segment pulse configuration table

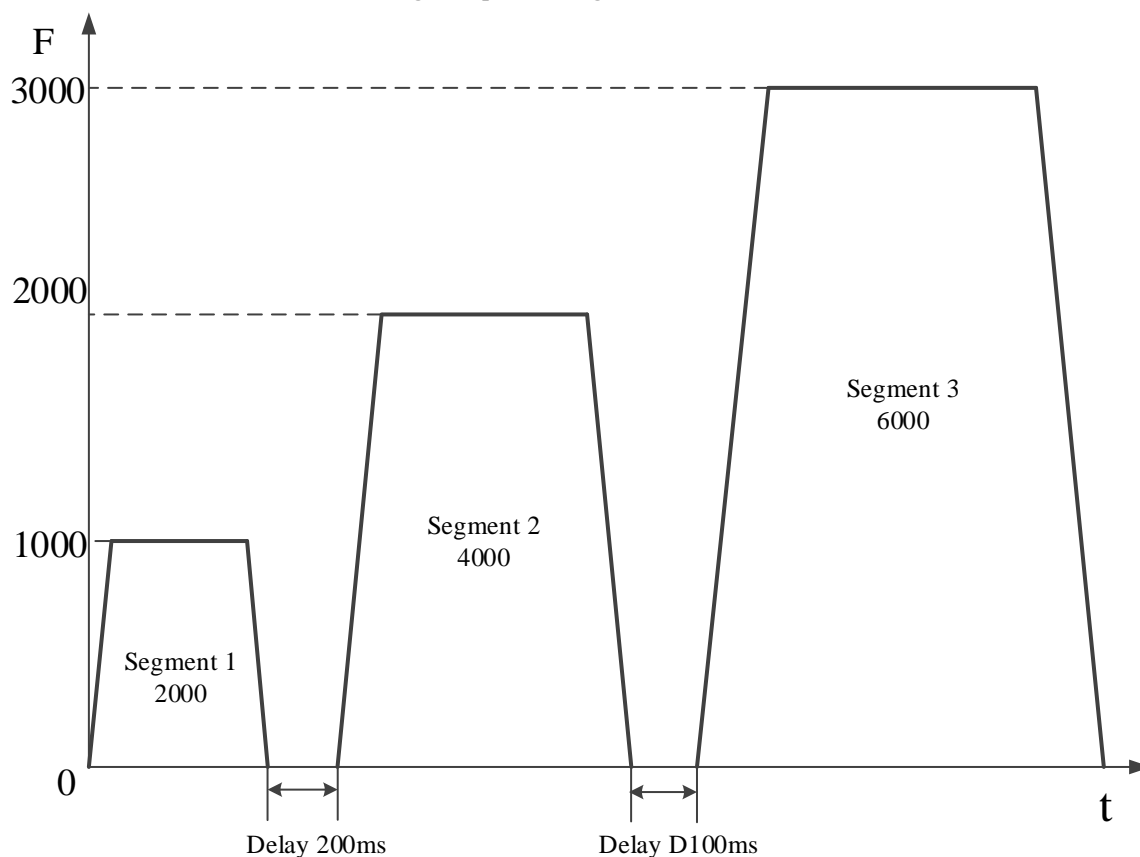

Pulse sending diagram

**Note:**

※1: the acceleration deceleration time can be set in **【config】** list, all the parameter details are in **【config guide】** .

※2: delay time range: 1~32767ms, set to 0 will be seemed to 1ms.

※3: if the delay time is over 32767ms, please use two pulse instructions, and timer between them.

● **Wait signal (H02)**

It will wait for the wait signal after pulse sending finished. When the signal is ON or from OFF to ON, it will jump to appointed segment. The wait signal can be X, M, HM and so on.

**For example:**

When the relative mode pulse instruction is triggered, it will send 2000 pulses with the speed 1000Hz, after segment 1 finished, it will wait for the M10 from OFF to ON, then jump to segment 2 which will send 4000 pulses with the speed 2000Hz, it will wait for X2 from OFF to ON, then jump to segment 3 which will send 6000 pulses.

Configurations:

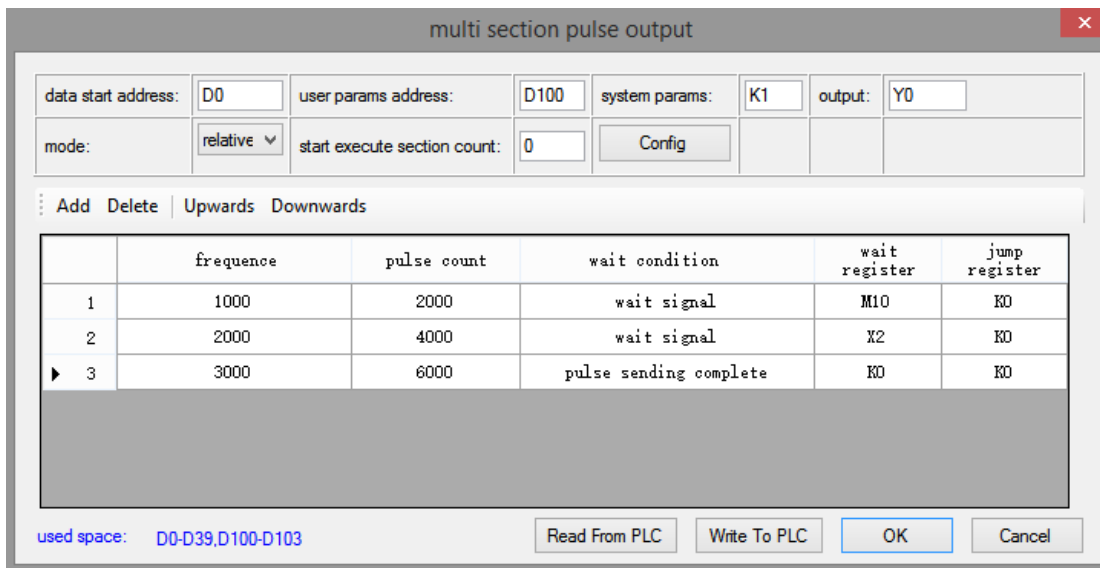

**Multi-segment pulse output configuration table**

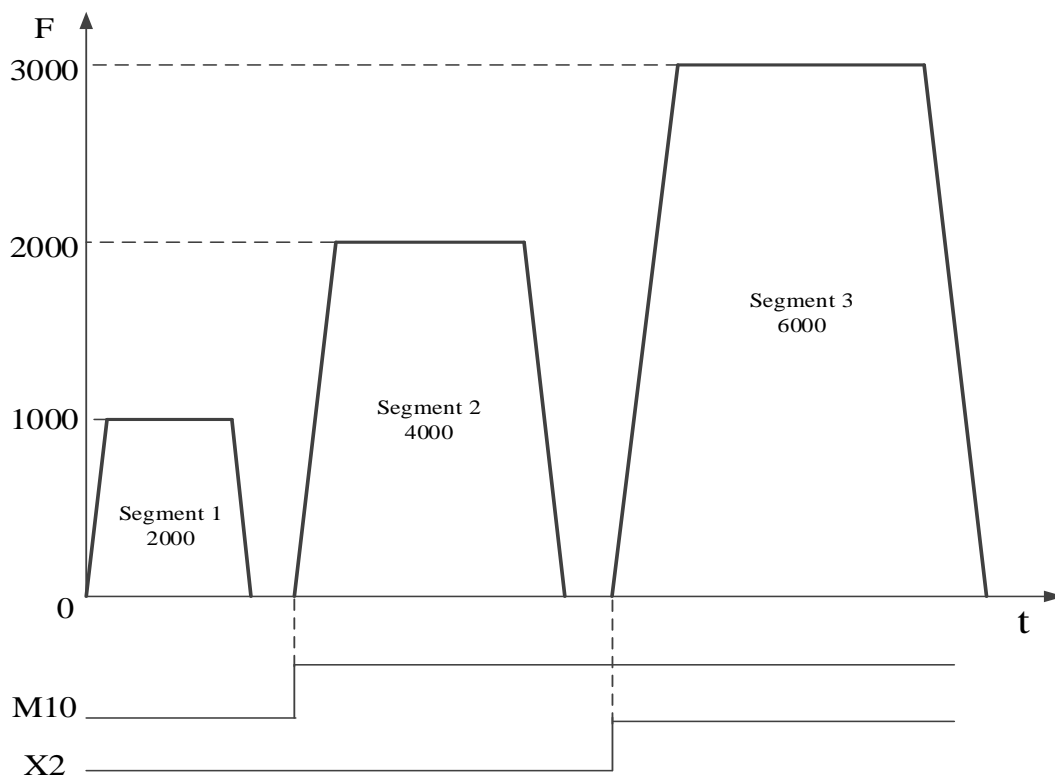

**Pulse sending diagram**

**Note:**

※1: the acceleration deceleration time can be set in **【config】** list, all the parameter details are in **【config guide】** .

※2: if the present segment has not finished, but the wait signal is ON, it will jump to next segment after present segment finished, the wave is shown as below (M10 from OFF to ON in advance)

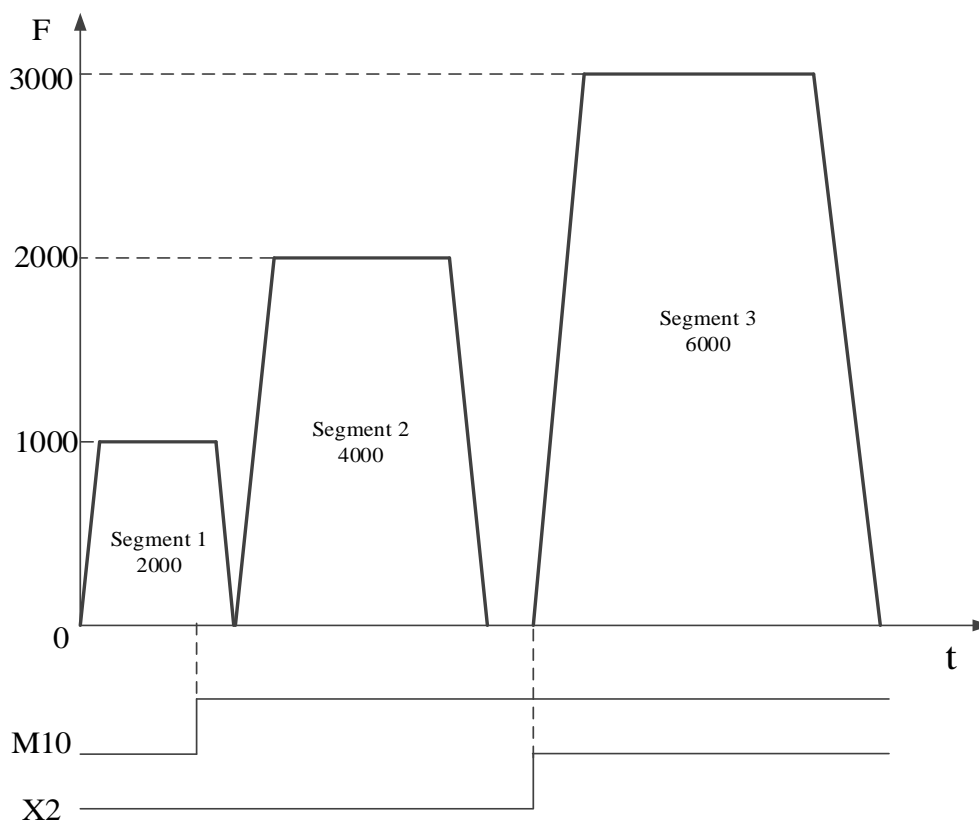

**Pulse sending diagram**

※3: if the wait signal is not ON after the present segment finished, it will wait until the signal is ON, then jump to the next segment.

- **ACT time (H03)**

The pulse will output for the time appointed by ACT time, no matter the pulse sending process is finished or not, it will jump to the next segment at once. ACT time can be constant, or set through register D, HD, FD, the unit is ms.

For example: when the relative mode pulse instruction PLSR is triggered by pulse edge, it will output the first segment of pulse numbers with the speed 1000Hz, when the first segment pulse output time reaches 1200ms, no matter the pulse sending process is finished or not, it will jump to the second segment at once. When the second segment of pulse outputs with the speed 2000Hz and reaches the time setting in D100 (for example D100=1000), no matter the pulse sending process is finished or not, it will jump to the third segment at once and output 6000 pulses.

The configuration:

multi section pulse output

data start address: HD0 user params address: HD100 system params: K1 output: Y0

mode: relative start execute section count: 0 Config

Add Delete Upwards Downwards

	frequency	pulse count	wait condition	wait register	jump register
1	1000	2000	ACT time	K1200	K0
2	2000	4000	ACT time	D100	K0
▶ 3	3000	6000	pulse sending complete	K0	K0

used space: HD0-HD39,HD100-HD103 Read From PLC Write To PLC OK Cancel

Multi-segment pulse output configuration

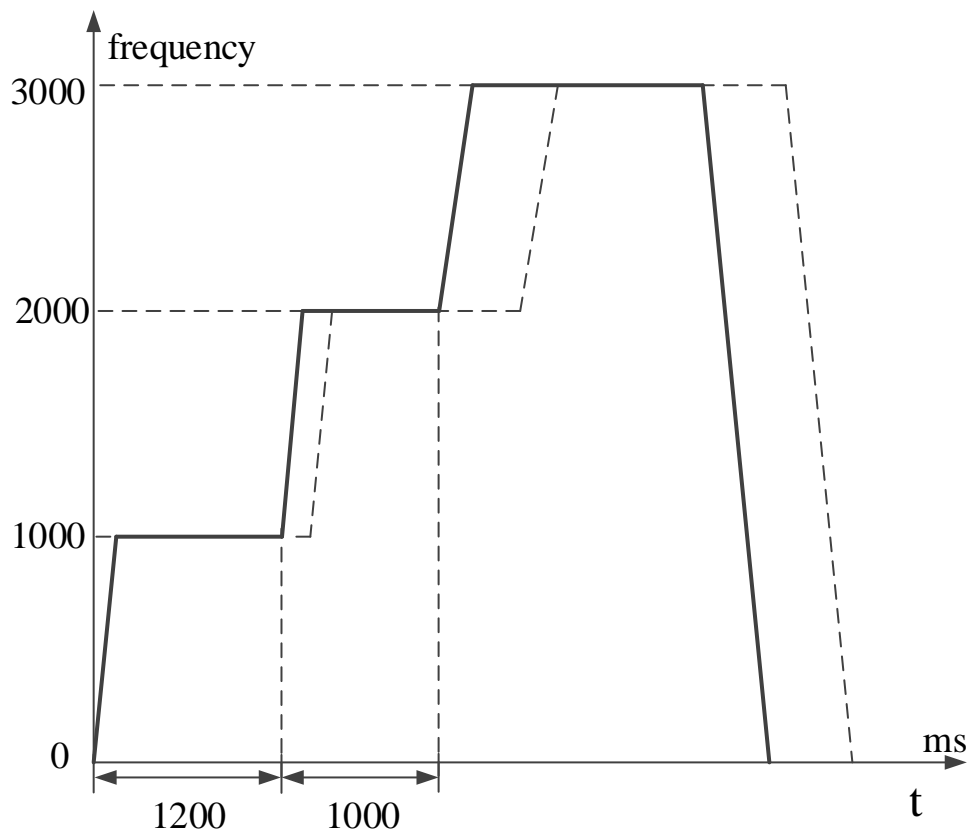

Pulse output diagram

**Note:**

- 1: the acceleration time and deceleration time can be set in the parameter table, it will be explained in system parameters.
- 2: if the ACT time is very short and in the acceleration stage of the pulse segment, it will accelerate to the second segment from the position of ACT time reached, the same, it will accelerate to the third segment from the position of ACT time reached. Please see as the below diagram.

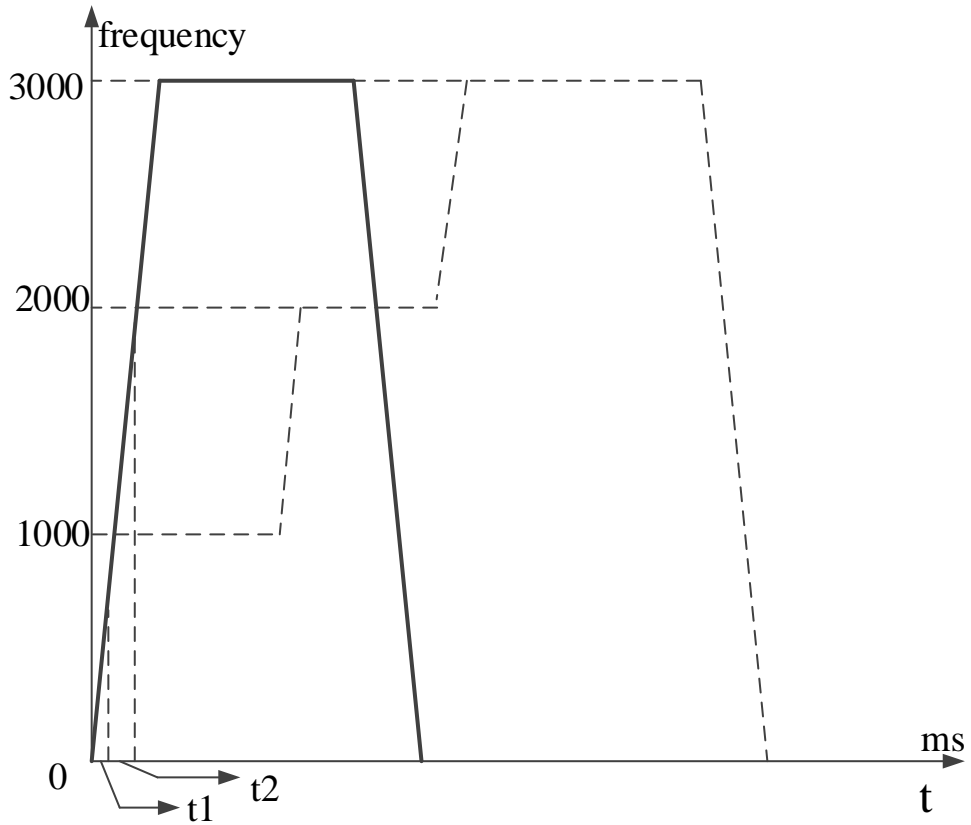

Pulse output diagram

3: if the ACT time is very long, and in the deceleration stage of the pulse segment, it will accelerate to the second segment from the position of ACT time reached, the same, it will accelerate to the third segment from the position of ACT time reached. Please see as the below diagram.

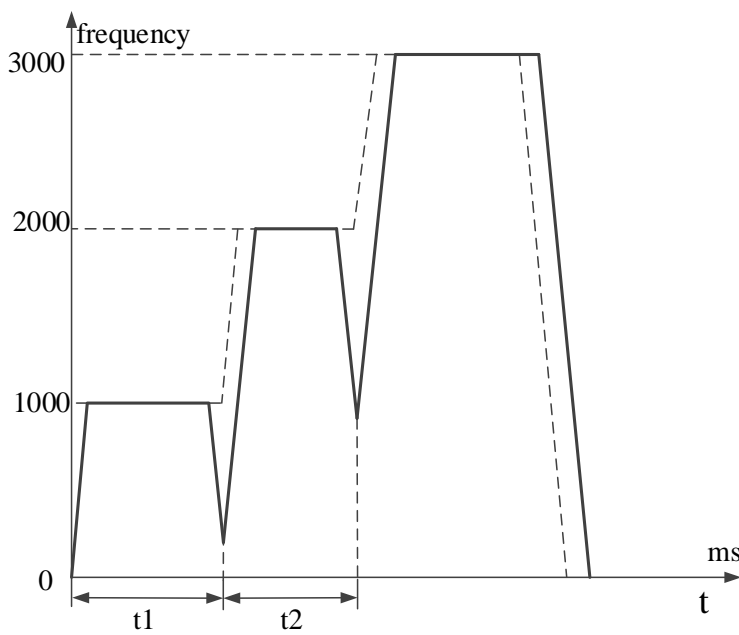

Pulse output digram

4: if the ACT time is very long, and the present pulse segment ends, it will wait the ACT time arrival and start the next segment. Please see the below diagram.

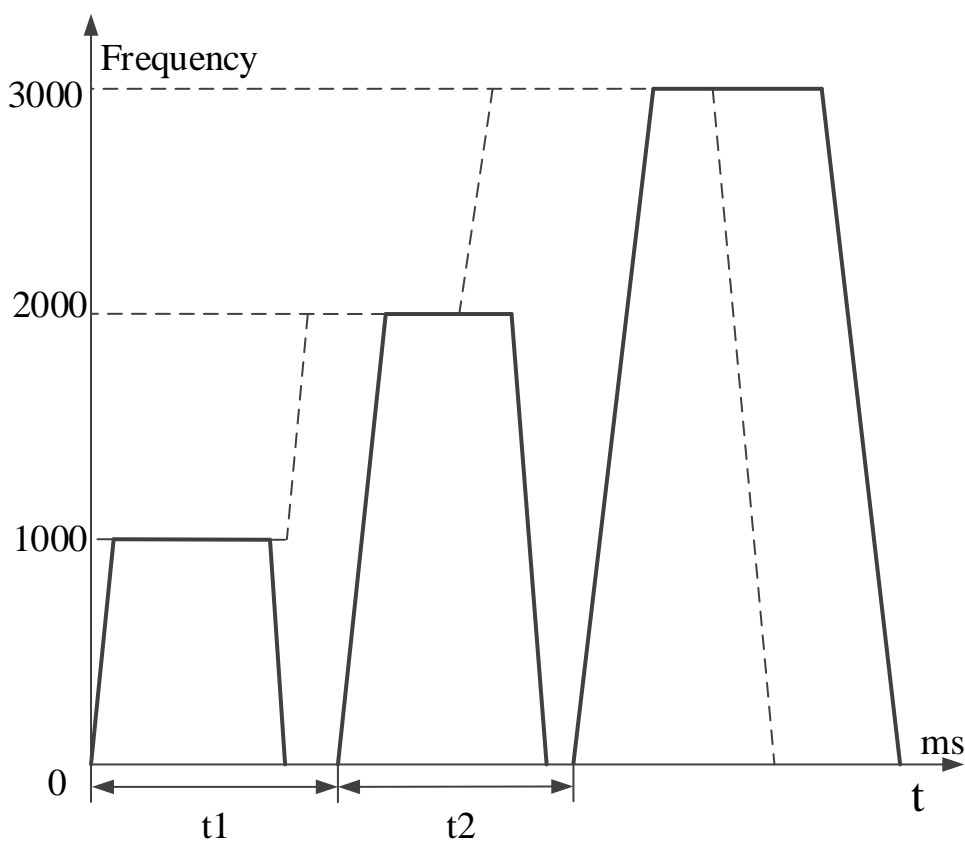

Pulse output diagram

- **EXT signal (H04)**

When the pulse is outputting (the pulse numbers have not been sent yet), if external signal is ON, it will jump to the next appointed segment. If the external signal has no action when the present pulse segment ends, it will wait for this signal. The external signal will input from X terminal (the response is higher if using external interruption terminal).

For example: when the relative mode pulse instruction PLSR is triggered by pulse edge, it will output the first segment of pulse numbers with the speed 1000Hz, the external signal inputs from X0 during the pulse is sending, it will jump to segment 2 at once. When the segment 2 pulse is sending with the speed 2000Hz, the external signal inputs from X1, it will jump to segment 3 at once. When the segment 3 pulse is sending with the speed 3000Hz, external signal inputs from X2, it will slow stop the pulse output at once.

The configuration window:

multi section pulse output

data start address: HD0 user params address: HD100 system params: K1 output: Y0

mode: relative start execute section count: 0 Config

Add Delete Upwards Downwards

	frequency	pulse count	wait condition	wait register	jump register
1	1000	2000	EXT signal	X0	K0
2	2000	4000	EXT signal	X1	K0
▶ 3	3000	6000	EXT signal	X2	K0

used space: HD0-HD39,HD100-HD103

Read From PLC Write To PLC OK Cancel

Multi-segment pulse output configuration

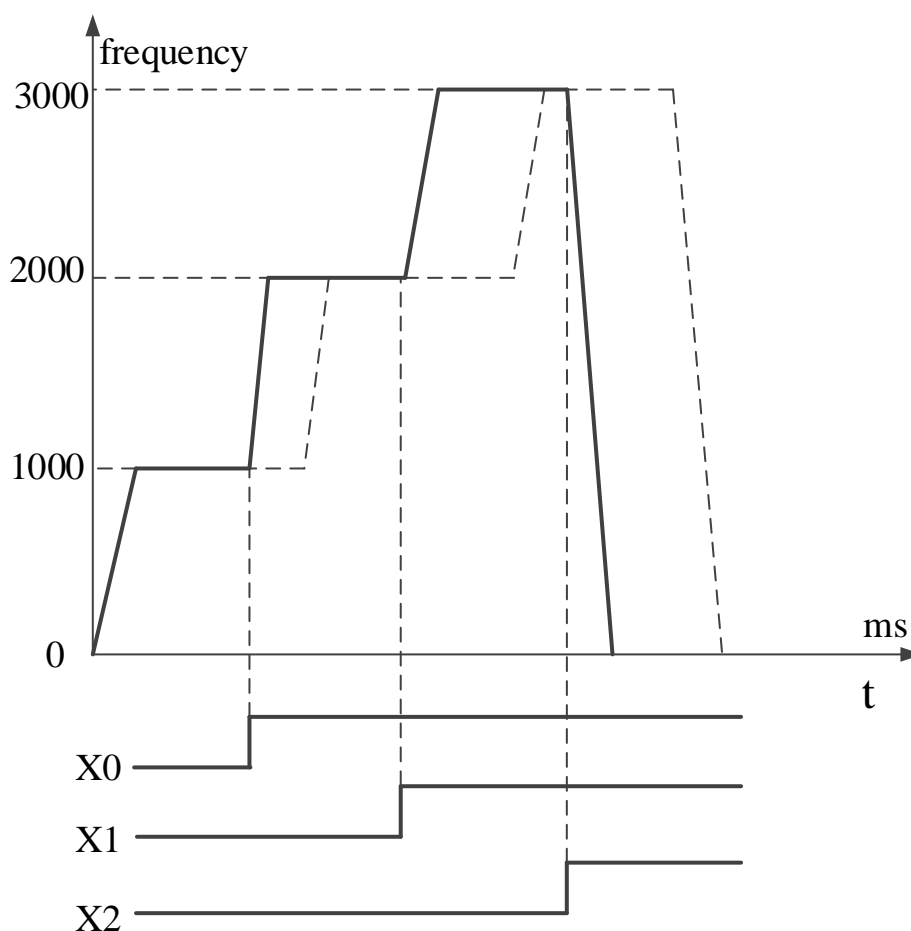

Pulse output diagram

**Note:**

- 1: the acceleration and deceleration time can be set in parameter table, please refer to system parameters for details.
- 2: the pulse is accelerating when the EXT signal is triggered, it will accelerate from the present position to pulse segment 2. The same, it will accelerate from the present position of EXT signal



triggered to segment 3. As shown of below diagram:

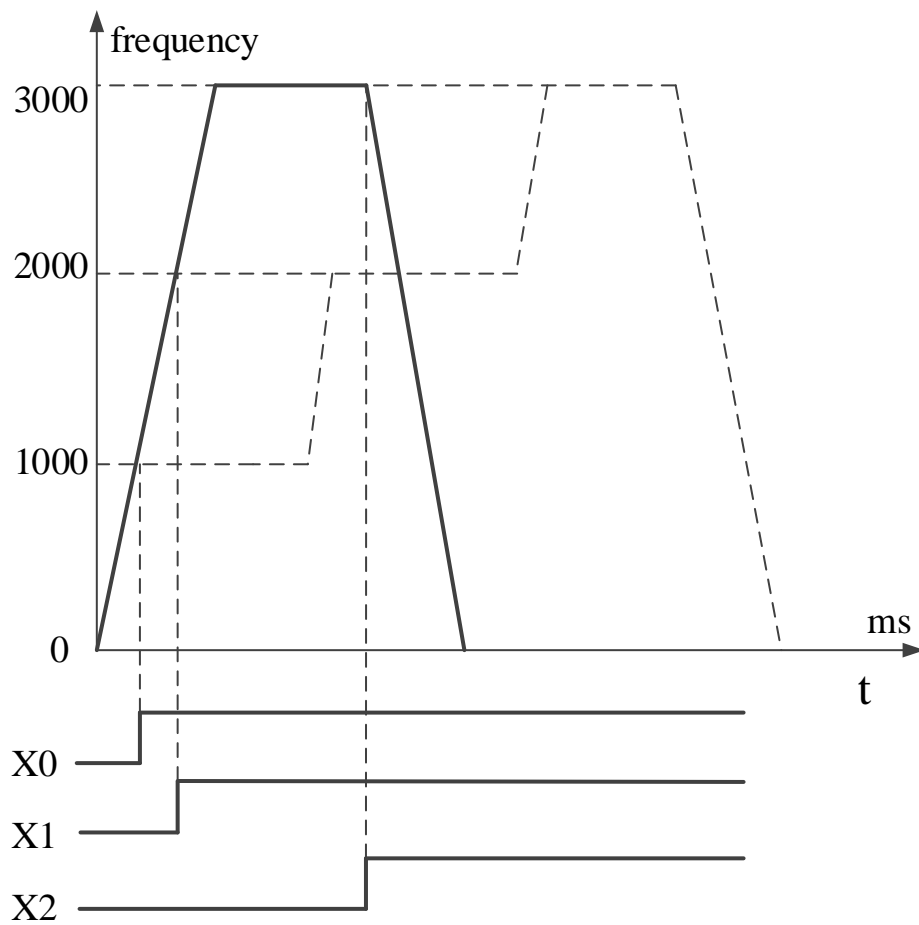

Pulse output diagram

3: if the EXT signal is triggered when the present pulse already ends, it will wait the EXT signal and start the next segment. Refer to below diagram.

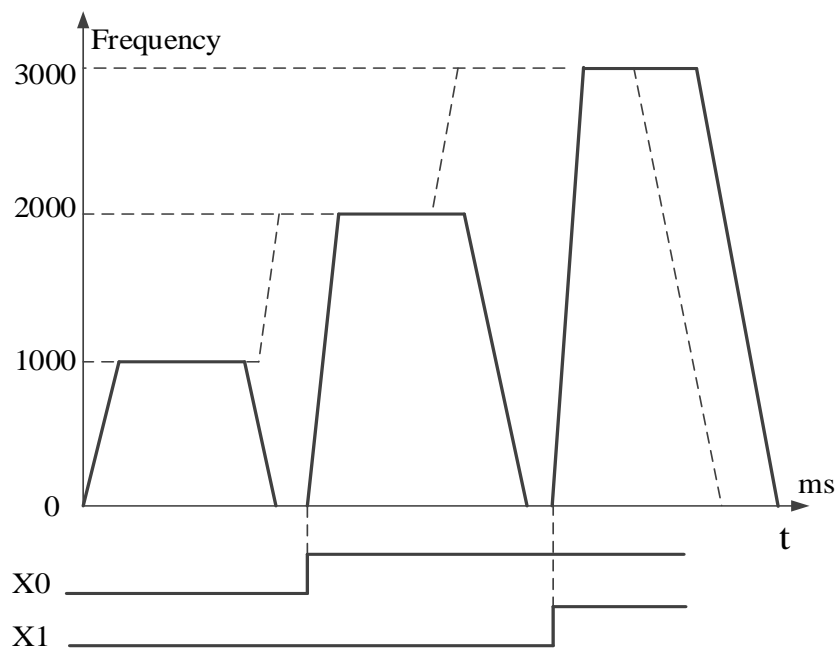

Pulse output diagram

4: if the EXT signal is triggered when the pulse is decelerating, it will accelerate from present position to pulse segment 2, the same way, it will accelerate to pulse segment 3 from the position EXT signal is triggered. Refer to below diagram:

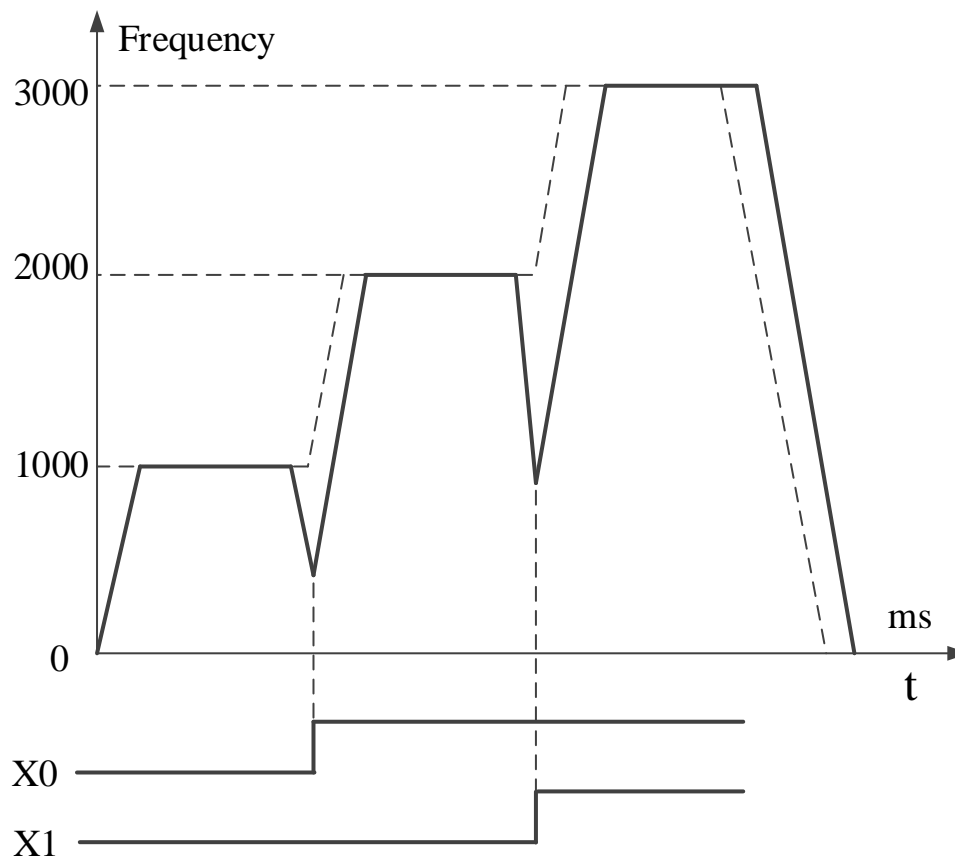

Pulse output diagram

- **EXT signal/pulse sending complete (H05)**

It will jump to appointed segment when the bit signal is triggered or pulse sending completes.

If the external signal is triggered before the pulse sending ends, it will jump to appointed segment, otherwise it will jump to appointed segment when present segment finishes (the pulse segment will send pulse as configuration parameters, if there is external EXT signal, it will not continue the present segment but jump to appointed segment).

For example:

multi section pulse output ✕

data start address: HD0	user params address: HD100	system params: K1	output: Y0
mode: relative	start execute section count: 0	Config	

⋮ Add Delete | Upwards Downwards

	frequency	pulse count	wait condition	wait register	jump register
1	1000	2000	EXT signal/pulse sending com...	X0	K0
2	2000	4000	EXT signal/pulse sending com...	X1	K0
▶ 3	3000	6000	EXT signal/pulse sending com...	X2	K0

used space: HD0-HD39,HD100-HD103

Read From PLC Write To PLC OK Cancel

### Multi-segment pulse configuration

EXT signal X0 is valid when segment 1 pulse is sending(frequency 1000Hz, pulse number 2000),  
 EXT signal X1 is valid when segment 2 pulse is sending(frequency 2000, pulse number 4000),  
 EXT signal X2 is valid when segment 3 pulse is sending(frequency 3000Hz, pulse number 6000).

#### ■ Wait register

##### ● Constant (H00)

The value in register  $S0+N*10+5$  (double word) is constant, range K0~K2147483647, eg. K2, K6, K3000.

##### ● D (H01)

The value in register  $S0+N*10+5$  (double word) is register D, for example, D0, D200.

##### ● HD (H02)

The value in register  $S0+N*10+5$  (double word) is register HD(latched register), for example HD0, HD200.

##### ● FD (H03)

The value in register  $S0+N*10+5$  (double word) is register FD(Flash register), for example, FD0, FD200.

##### ● X (H04)

The value in register  $S0+N*10+5$  (double word) is X(input signal), if the signal is external interruption terminal, the pulse will be triggered by interruption signal(response faster), for example X0, X6.

##### ● M (H05)

The value in register  $S0+N*10+5$  (double word) is M(normal coil), for example, M0, M200.

##### ● HM (H06)

The value is register  $S0+N*10+5$  (double word) is HM(latched coil), for example, HM0, HM200.

#### ■ Jump register

##### ● Constant (H00)

The register value in  $S0+N*10+8$  (double word) is constant, range K0~K100, for example K2, K6.

##### ● D (H01)

The value in register  $S0+N*10+8$  (double word) is D(normal register), for example D0, D200.

- **HD (H02)**

The value in register  $S0+N*10+5$  (double word) is HD(latched register), for example HD0, HD200.

- **FD (H03)**

The value in register  $S0+N*10+5$  (double word) is FD(Flash register), for example FD0, FD200.

**Note:**

- 1: whatever it is constant or register, the value range is K0~K100.
- 2: this parameter means the present pulse segment ends and jumps to appointed segment. For example, the value is K6, it will jump to pulse segment 6 when the present pulse segment ends.
- 3: if the jump register or constant is 0, it will jump to next segment, if there is no next pulse segment, it will finish the present pulse segment then stop.
- 4: if the constant or register value is present segment number, it will infinite loop the present pulse segment.

### 1-2-1-2. Pulse user parameters (S1)

The pulse user parameters start from S1.

#### The pulse user parameters starting address (S1)

Address	Content
S1+0 (double word)	Pulse relative/absolute mode (0: relative 1: absolute) * <sup>1</sup>
S1+2 (double word)	Pulse start execution segment number ( 1~100)* <sup>2</sup>

#### a. Relative/absolute mode

S1+0 (double word) defines the pulse configuration mode is relative or absolute, default is relative mode.

data start address:	<input type="text" value="D0"/>	user params address:	<input type="text" value="D100"/>	system params:	<input type="text" value="K1"/>	output:	<input type="text" value="Y0"/>
mode:	<input type="text" value="relative"/>	start execute section count:	<input type="text" value="0"/>	<input type="button" value="Config"/>			

#### For example:

There are 3 segments of pulse, segment 1 is 2000 pulse numbers, 1000Hz, segment 2 is 4000 pulse numbers, 2000Hz, segment 3 is 6000 pulse numbers, 3000Hz. The pulse configuration is shown as below:

	frequence	pulse count	wait condition	wait register	jump register
1	1000	2000	pulse sending complete	K0	K0
▶ 2	2000	4000	pulse sending complete	K0	K0
3	3000	6000	pulse sending complete	K0	K0

**Relative mode configuration table**

	frequence	pulse count	wait condition	wait register	jump register
1	1000	2000	pulse sending complete	K0	K0
2	2000	6000	pulse sending complete	K0	K0
▶ 3	3000	12000	pulse sending complete	K0	K0

**Absolute mode configuration table**

**b. Start execution segment**

Start execution segment means the pulse instruction start segment (the pulse will start from the appointed segment but not segment 1).

Note: if it is set to 0 or 1, it will start from segment 1.

data start address:	D0	user params address:	D100	system params:	K1	output:	Y0
mode:	relative ▼	start execute section count:	0	Config			

**For example:**

There are three segments of pulse: segment 1 is 1000Hz, 2000 pulse numbers, segment 2 is 2000Hz, 4000 pulse numbers, segment 3 is 3000Hz, 6000 pulse numbers, the start execution segment is 2:

multi section pulse output					
	frequence	pulse count	wait condition	wait register	jump register
1	1000	2000	pulse sending complete	K0	K0
2	2000	4000	pulse sending complete	K0	K0
▶ 3	3000	6000	pulse sending complete	K0	K0

used space: HD0-HD39,HD100-HD103

Read From PLC Write To PLC OK Cancel

**Multi-segment pulse output configuration table**

The PLSR will send 4000 pulse numbers with the speed 2000Hz, then send 6000 pulse numbers with the speed 3000Hz.

**1-2-1-3. System parameters (S2)**

There are 4 groups of system parameters. User can select one of them to execute the pulse output. Each pulse output terminal has related system parameter address.

User can set the system parameter group no. in S2 (constant, register D, HD, FD...). As the following figure, system parameter group is 2, output terminal is Y0.

data start address:	HD0	user params address:	HD100	system params:	K2	output:	Y0
mode:	relative	start execute section count:	0	Config			

Click “config” button to enter system parameters.

Param	Value
Y0 axis-Common-Parameters setting-Pulse direction logic	positive logic
Y0 axis-Common-Parameters setting-enable soft limit	disable
Y0 axis-Common-Parameters setting-mechanical back to...	negative
Y0 axis-Common-Parameters setting-Pulse unit	pulse number
Y0 axis-Common-Parameters setting-Interpolation coord...	Cross coordi...
Y0 axis-Common-pulse send mode	complete
Y0 axis-Common-Pulse num (1)	1
Y0 axis-Common-Offset (1)	1
Y0 axis-Common-Pulse direction terminal	Y no terminal
Y0 axis-Common-Delayed time of pulse direction (ms)	10
Y0 axis-Common-Gear clearance positive compensation	0

Click “config” can configure 10 channels (Y0~Y11) system parameters. Click each parameter to set the value:

Param	Value
Y0 axis-Common-Parameters setting-Pulse direction logic	positive logic
Y0 axis-Common-Parameters setting-enable soft limit	disable
Y0 axis-Common-Parameters setting-mechanical back to...	negative
Y0 axis-Common-Parameters setting-Pulse unit	pulse number
Y0 axis-Common-Parameters setting-Interpolation coord...	Cross coordi...
Y0 axis-Common-pulse send mode	complete
Y0 axis-Common-Pulse num (1)	1
Y0 axis-Common-Offset (1)	1
Y0 axis-Common-Pulse direction terminal	Y no terminal
Y0 axis-Common-Delayed time of pulse direction (ms)	10
Y0 axis-Common-Gear clearance positive compensation	0

Some instructions do not have panel configuration mode, when user needs to set the system parameters, please click the left side of software, and click “pulse” to set the parameters.

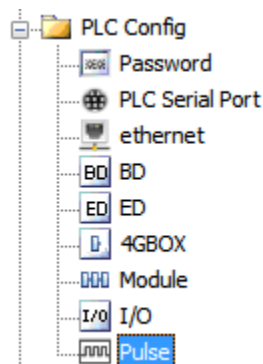

Then click “config” to set the parameters:

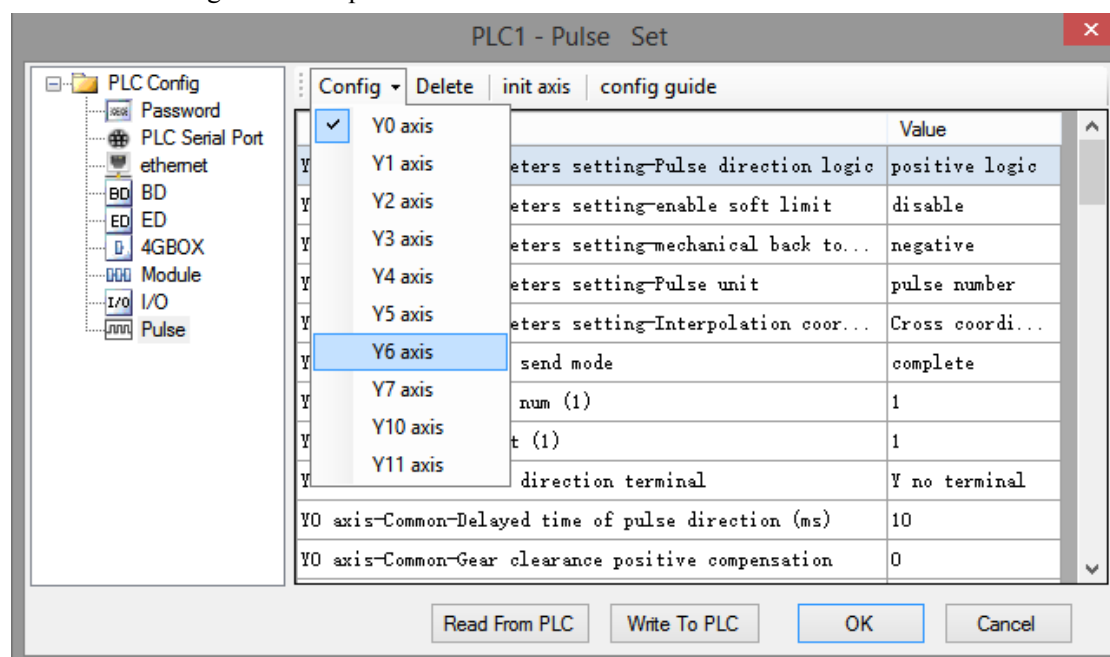

**Note:**

For the same pulse output terminal, the system parameters are shared. For example, if set the system parameters is K1, all the pulse instructions for Y0 will use system parameter group 1.

The following table shows the 5 groups of system parameter of first channel (Y0), each group of parameter can set different pulse default speed, pulse default speed acceleration and deceleration time, gear clearance acceleration/deceleration time, max speed limit, start speed and end speed... (please see below details).

Take first channel (Y0) as an example, other terminal system parameters please refer to appendix 3.

Address	Parameter	Explanation
<b>Y0 (common parameters)</b>		
SFD900	Pulse parameters	Bit1: pulse direction logic 0: positive logic, 1: negative logic, default is 0 Bit2: soft position limit 0: OFF 1: ON, default is 0 Bit3: machine back to origin direction 0: negative direction 1: positive direction, default is 0 Bit4: motor operation mode (closed loop pulse) 0: position mode 1: pulse mode, default is 0 Bit10~ Bit8: pulse unit Bit8: 0: pulse numbers, 1: equivalent 000: pulse numbers 001: micron 011: centimillimeter 101: decimillimeter 111: millimeter Default is 000 Bit13: pulse type 0: single direction pulse 1: AB phase pulse (only for XD5-48D4T4-E), default is 0 Bit15: interpolation coordinate mode 0: cross coordinate, 1: polar coordinate, default is 0
SFD901	Pulse output mode	Bit0: pulse output mode 0: completion mode, 1: subsequent mode Default is 0
SFD902	Pulse number/1 rotate low 16-bit	
SFD903	Pulse number/1 rotate high 16-bit	
SFD904	Movement amount/1 rotate low 16-bit	
SFD905	Movement amount/1 rotate high 16-bit	
SFD906	Pulse direction terminal	The number of terminal Y, 0xFF is no terminal
SFD907	Direction delay time	Default is 20, unit: ms
SFD908	Gear clearance positive compensation	



SFD909	Gear clearance negative compensation	
SFD910	Electric origin low 16-bit	
SFD911	Electric origin high 16-bit	
SFD912	Signal terminal state setting	Bit0: origin signal ON/OFF state Bit1: Z phase ON/OFF state Bit2: positive limit ON/OFF state Bit3: negative limit ON/OFF state 0: normally ON(positive logic), 1: normally close(negative logic), default is 0
SFD913	Origin signal terminal setting	
SFD914	Z phase terminal setting	Bit0~Bit7: X terminal number, 0xFF is no terminal
SFD915	Limit terminal setting	Bit7~Bit0: positive limit X terminal number, 0xFF is no terminal Bit15~Bit8: negative limit X terminal number, 0xFF is no terminal
SFD917	Zero clear CLR signal output terminal setting	Bit0~Bit7: Y terminal number, 0xFF is no terminal
SFD918	Return speed VH low 16-bit	
SFD919	Return speed VH high 16-bit	
SFD922	Crawling speed VC low 16-bit	
SFD923	Crawling speed VC high 16-bit	
SFD924	Mechanical origin low 16-bit	
SFD925	Mechanical origin high 16-bit	
SFD926	Z phase numbers	
SFD927	CLR signal delay time	Default is 20, unit: ms
SFD928	Wheel radius (polar coordinate)	Low 16-bit
SFD929		High 16-bit
SFD930	Soft limit positive pole value	Low 16-bit
SFD931		High 16-bit
SFD932	Soft limit negative pole value	Low 16-bit
SFD933		High 16-bit
SFD934	Encoder pulse number/1 rotate (closed-loop pulse)	Low 16-bit
SFD935		High 16-bit
SFD936	Encoder offset/1 rotate (closed-loop pulse)	Low 16-bit
SFD937		High 16-bit
SFD938	Width of complete orientation (closed-loop pulse)	
SFD939	Limit of deviation position (closed-loop pulse)	

SFD940	Motor rated speed (closed-loop pulse)	
SFD941	Rated speed corresponding frequency (100Hz) (closed loop pulse)	
SFD942	Positioning completion time limit (ms) (closed loop pulse)	
SFD943	Motion control default parameter block	Bit0~bit7: fast positioning instruction default parameter block 0~4, default is 1 Bit8~bit15: interpolation instruction default parameter block 0~4, default is 2
.....		
<b>Y0 (group0 parameters)</b>		
HSD460	Pulse default speed low 16-bit	It will output pulse with default speed when the speed is 0
HSD461	Pulse default speed high 16-bit	
HSD462	Pulse default speed acceleration time	
HSD463	Pulse default speed deceleration time	
HSD464	Gear clearance acc/dec time	
HSD465	Acceleration deceleration mode	Bit1~Bit0: acc/dec mode 00: linear acc/dec 01: S curve acc/dec 10: sine curve acc/dec 11: reserved Bit15~ Bit2: reserved
HSD466	Max speed limit low 16-bit	
HSD467	Max speed limit high 16-bit	
HSD468	Start speed low 16-bit	
HSD469	Start speed high 16-bit	
HSD470	End speed low 16-bit	
HSD471	End speed high 16-bit	
HSD472	Follow performance parameter	1~100, 100 means the time constant is one tick, 1 means the time constant is 100 ticks.
HSD473	Follow feedforward compensation parameter	0~100, percentage
HSD474	Pulse frequency refresh time	1ms, 0.1ms
HSD475	ZRN regression velocity VH	Low 16-bit
HSD476		High 16-bit
HSD477	ZRN crawl speed VC	Low 16-bit

HSD478		High 16-bit
.....		
<b>Y0 (group1 parameters)</b>		
SFD950	Pulse default speed low 16-bit	It will output pulse with default speed when the speed is 0
SFD951	Pulse default speed high 16-bit	
SFD952	Pulse default speed acceleration time	
SFD953	Pulse default speed deceleration time	
SFD954	Gear clearance acc/dec time	
SFD955	Acceleration deceleration mode	Bit1~Bit0: acc/dec mode 00: linear acc/dec 01: S curve acc/dec 10: sine curve acc/dec 11: reserved Bit15~ Bit2: reserved
SFD956	Max speed limit low 16-bit	
SFD957	Max speed limit high 16-bit	
SFD958	Start speed low 16-bit	
SFD959	Start speed high 16-bit	
SFD960	End speed low 16-bit	
SFD961	End speed high 16-bit	
SFD962	Follow performance parameter	1~100, 100 means the time constant is one tick, 1 means the time constant is 100 ticks.
SFD963	Follow feedforward compensation parameter	0~100, percentage
SFD964	Pulse frequency refresh time	1ms, 0.1ms
SFD965	ZRN regression velocity VH	Low 16-bit
SFD966		High 16-bit
SFD967	ZRN crawl speed VC	Low 16-bit
SFD968		High 16-bit
.....		
<b>Y0 (group2 parameters)</b>		
SFD970	Pulse default speed low 16-bit	It will output pulse with default speed when the speed is 0
SFD971	Pulse default speed high 16-bit	
SFD972	Pulse default speed acceleration time	
SFD973	Pulse default speed deceleration time	
SFD974	Gear clearance acc/dec time	

SFD975	Acceleration deceleration mode	Bit1~Bit0: acc/dec mode 00: linear acc/dec 01: S curve acc/dec 10: sine curve acc/dec 11: reserved Bit15~ Bit2: reserved
SFD976	Max speed limit low 16-bit	
SFD977	Max speed limit high 16-bit	
SFD978	Start speed low 16-bit	
SFD979	Start speed high 16-bit	
SFD980	End speed low 16-bit	
SFD981	End speed high 16-bit	
SFD982	Follow performance parameter	1~100, 100 means the time constant is one tick, 1 means the time constant is 100 ticks.
SFD983	Follow feedforward compensation parameter	0~100, percentage
SFD984	Pulse frequency refresh time	1ms, 0.1ms
SFD985	ZRN regression velocity VH	Low 16-bit
SFD986		High 16-bit
SFD987	ZRN crawl speed VC	Low 16-bit
SFD988		High 16-bit
.....		
<b>Y0 (group3 parameters)</b>		
SFD990	Pulse default speed low 16-bit	It will output pulse with default speed when the speed is 0
SFD991	Pulse default speed high 16-bit	
SFD992	Pulse default speed acceleration time	
SFD993	Pulse default speed deceleration time	
SFD994	Gear clearance acc/dec time	
SFD995	Acceleration deceleration mode	Bit1~Bit0: acc/dec mode 00: linear acc/dec 01: S curve acc/dec 10: sine curve acc/dec 11: reserved Bit15~ Bit2: reserved
SFD996	Max speed limit low 16-bit	
SFD997	Max speed limit high 16-bit	
SFD998	Start speed low 16-bit	
SFD999	Start speed high 16-bit	
SFD1000	End speed low 16-bit	
SFD1001	End speed high 16-bit	

SFD1002	Follow performance parameter	1~100, 100 means the time constant is one tick, 1 means the time constant is 100 ticks.
SFD1003	Follow feedforward compensation parameter	0~100, percentage
SFD1004	Pulse frequency refresh time	1ms, 0.1ms
SFD1005	ZRN regression velocity VH	Low 16-bit
SFD1006		High 16-bit
SFD1007	ZRN crawl speed VC	Low 16-bit
SFD1008		High 16-bit
...		
<b>Y0 (group4 parameters)</b>		
SFD1010	Pulse default speed low 16-bit	It will output pulse with default speed when the speed is 0
SFD1011	Pulse default speed high 16-bit	
SFD1012	Pulse default speed acceleration time	
SFD1013	Pulse default speed deceleration time	
SFD1014	Gear clearance acc/dec time	
SFD1015	Acceleration deceleration mode	Bit1~Bit0: acc/dec mode 00: linear acc/dec 01: S curve acc/dec 10: sine curve acc/dec 11: reserved Bit15~ Bit2: reserved
SFD1016	Max speed limit low 16-bit	
SFD1017	Max speed limit high 16-bit	
SFD1018	Start speed low 16-bit	
SFD1019	Start speed high 16-bit	
SFD1020	End speed low 16-bit	
SFD1021	End speed high 16-bit	
SFD1022	Follow performance parameter	
SFD1023	Follow feedforward compensation parameter	0~100, percentage
SFD1024	Pulse frequency refresh time	1ms, 0.1ms
SFD1025	ZRN regression velocity VH	Low 16-bit
SFD1026		High 16-bit
SFD1027	ZRN crawl speed VC	Low 16-bit
SFD1028		High 16-bit

**Common parameter**

- Pulse direction logic

Pulse direction includes positive logic(default) and negative logic.

Positive logic: when the pulse numbers are positive value, it will output forward direction pulse (for example, HSD0 value is increasing), pulse direction terminal is ON. when the pulse numbers are negative value, it will output reverse direction pulse(for example, HSD0 value is decreasing), pulse direction terminal is OFF.

Negative logic: when the pulse numbers are positive value, it will output forward direction pulse (for example, HSD0 value is increasing), pulse direction terminal is OFF. when the pulse numbers are negative value, it will output reverse direction pulse(for example, HSD0 value is decreasing), pulse direction terminal is ON.

When the pulse is outputting, the direction terminal is ON, this terminal will not be reset automatically after the pulse output ends. The direction terminal will change the direction according to the pulse settings when pulse sends next time. If the pulse instruction has no direction, it needs to reset the direction terminal in the program.

Note:

1: this parameter default value is positive logic. All the program in this manual is made as positive logic.

2: fit for the instruction PLSR, PLSF, ZRN.

- Enable soft limit

In order to avoid the movement beyond the range of travel, the protection function is added to both ends of the travel. It is used to auto-search the origin signal and protect when backing to mechanical origin. It will judge the value of pulse accumulated register and protect the travel.

Note: soft limit and hardware limit can be used at the same time.

The parameter configuration:

Param	Value
Y0 axis-Common-Parameters setting-Pulse direction logic	positive logic
Y0 axis-Common-Parameters setting-enable soft limit	disable
Y0 axis-Common-Parameters setting-mechanical back to...	disable enable
Y0 axis-Common-Parameters setting-Pulse unit	pulse number

- Soft limit positive value

To prevent the table from moving beyond the range when executing the instruction PLSR, PLSF, DRVA, DRVI, interpolation instructions, it will add the value of present accumulated pulse register at the positive side of travel to protect the machine.

The configuration:

Y0 axis-Common-Z phase num	0
Y0 axis-Common-CLR signal delayed time (ms)	20
Y0 axis-Common-grinding wheel radius(polar)	0
Y0 axis-Common-soft limit positive value	0
Y0 axis-Common-soft limit negative value	0
Y0 axis-group 1-Pulse default speed	0

If the forward sending pulse reaches soft limit positive value for instruction PLSR, PLSF, DRVA,

DRVI, interpolation instruction, the pulse will slow stop. If the present cumulative pulse register value is over soft limit positive value, the forward pulse will always be prohibited, but the reverse pulse can be triggered.

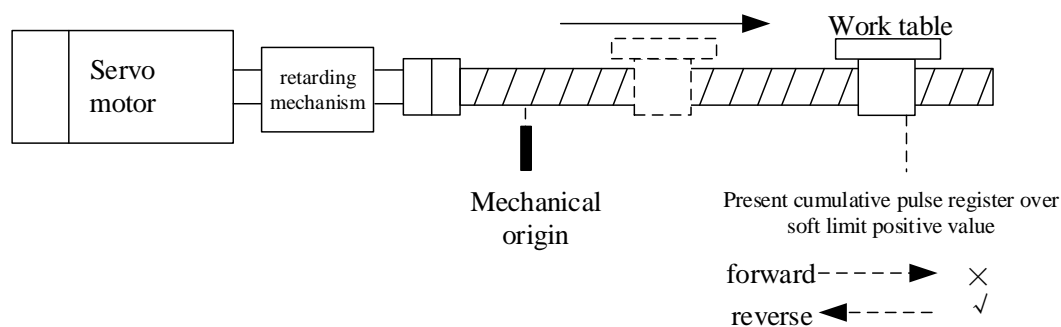

**Note:**

- 1: the parameter value cannot over max positive travel.
- 2: fit for PLSR, PLSF, DRVA, DRVI and interpolation instruction.

- Soft limit negative value

To prevent the table from moving beyond the range when executing the instruction PLSR, PLSF, DRVA, DRVI, interpolation instructions, it will add the value of present accumulated pulse register at the negative side of travel to protect the machine.

The configuration:

Y0 axis-Common-soft limit positive value	0
Y0 axis-Common-soft limit negative value	0
Y0 axis-group 1-Pulse default speed	0

If the forward sending pulse reaches soft limit negative value for instruction PLSR, PLSF, DRVA, DRVI, interpolation instruction, the pulse will slow stop. If the present cumulative pulse register value is lower than soft limit negative value, the reverse pulse will always be prohibited, but the forward pulse can be triggered.

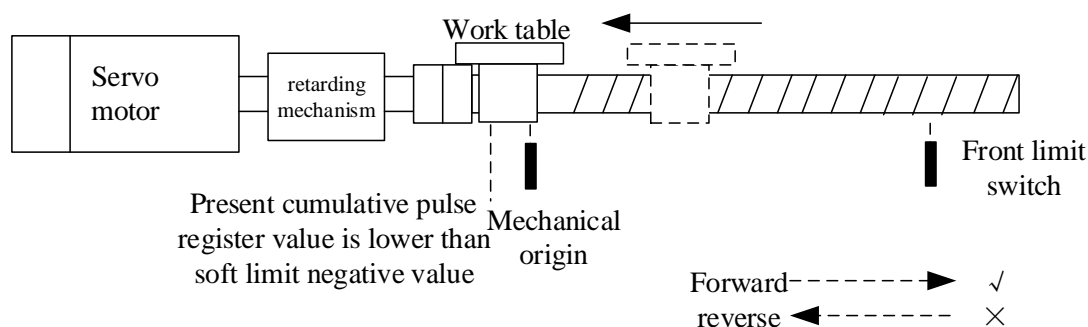

**Note:**

- 1: the parameter value cannot below min negative travel.
- 2: fit for PLSR, PLSF, DRVA, DRVI and interpolation instruction.

- Mechanical back to origin default direction

The work table default movement direction when the mechanical back to origin instruction ZRN is executed. The configuration:

YO axis-Common-Parameters setting-enable soft limit	disable
YO axis-Common-Parameters setting-mechanical back to the...	negative
YO axis-Common-Parameters setting-Pulse unit	pulse number
YO axis-Common-Parameters setting-Interpolation coordina...	Cross coordi...

Negative: the work table will move in reverse direction when executing ZRN.

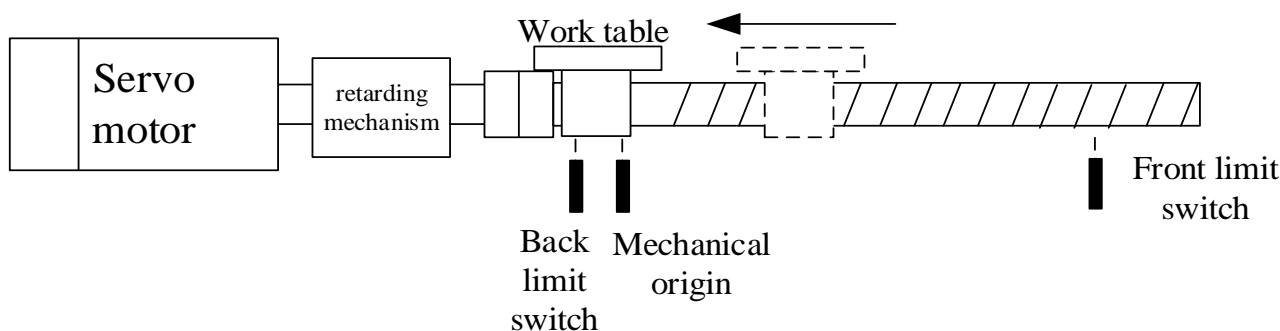

Positive: the work table will move in forward direction when executing ZRN.

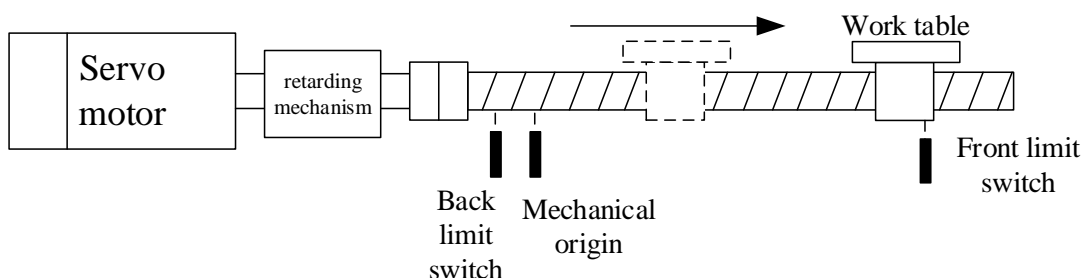

- Pulse unit

The pulse unit include pulse number(default) and equivalent (1um, 0.01mm, 0.1mm,1mm optional).

axis-Common-Parameters setting-mechanical back to the...	negative
axis-Common-Parameters setting-Pulse unit	pulse number ▾
axis-Common-Parameters setting-Interpolation coordina...	pulse number
axis-Common-pulse send mode	1um 0.01mm 0.1mm
axis-Common-Pulse num (1)	1mm

pulse number: if the pulse unit is pulse number, all the pulse frequency and number in the configuration table are calculated by pulse number. for example:



	frequence	pulse count	wait condition	wait register	jump register
1	1000	2000	pulse sending complete	K0	K0
2	2000	4000	pulse sending complete	K0	K0
▶ 3	3000	6000	pulse sending complete	K0	K0

There are three segments in the configuration table, segment 1 will send 2000 pulses at the speed 1000Hz, segment 2 will send 4000 pulses at the speed 2000Hz, segment 3 will send 6000 pulses at the speed 3000Hz.

Equivalent: 1um, 0.01mm, 0.1mm, 1mm optional. All the pulse frequency and equivalent in the configuration table are calculated by length unit. Before explaining the equivalent, we will introduce pulse number (1 rotate) and offset(1 rotate) first.

- Pulse number (1 rotate)

The pulse number that the transmission mechanism rotates 1 circle. As there is retarding mechanism, the motor rotates one circle does not mean the transmission mechanism rotates one circle.

For example: one servo motor drives lead screw through retarding mechanism, the servo drive model is DS2-20P7-AS, servo motor model is MS-80ST-M02430B-20P7(encoder 2500 ppr), the servo drive electronic gear ratio is 1:1, reduction ratio of retarding mechanism is 1:5, the pitch of the ball screw is 5mm.

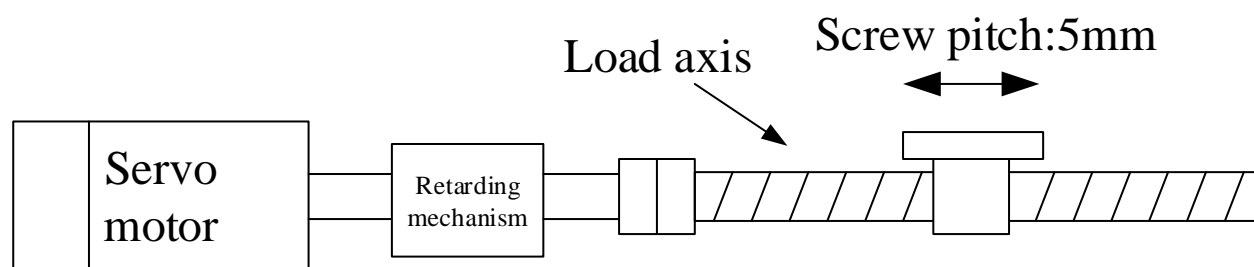

The pulse number of ball screw rotating one circle:

$$50000 = 2500 * 4 * \frac{5}{1}$$

- Offset(1 rotate)

The movement quantity of transmission mechanism rotates 1 circle. For example, in the above application, the offset is the ball screw pitch 5mm. If the object is synchronous belt, the offset is the synchronous belt transmission mechanism shaft perimeter.

After knowing the pulse number and offset, next we will understand how to set the equivalent. We will send three segments of pulse through the above mechanical structure.

	frequence	pulse count	wait condition	wait register	jump register
1	10	20	pulse sending complete	K0	K0
2	15	30	pulse sending complete	K0	K0
▶ 3	20	40	pulse sending complete	K0	K0

It configured three segments in above table. The pulse unit is equivalent. Segment 1 will move 20mm at the speed 10mm/s, segment 2 will move 30mm at the speed of 15mm/s, segment 3 will move 40mm at the speed of 20mm/s. The common parameters are configured as the below table:

axis-Common-Parameters setting-Pulse unit	1mm
axis-Common-Parameters setting-Interpolation coordina...	Cross coordi...
axis-Common-pulse send mode	complete
axis-Common-Pulse num (1)	50000
axis-Common-1mm(revolve)	5

transform the equivalent to related pulse frequency and pulse number, please see below table:

No.	Pulse unit	Frequency/speed	Pulse number/length
1	equivalent	10mm/s	20mm
	Pulse number	100000pulse/s	200000 pulse
2	equivalent	15mm/s	30mm
	Pulse number	150000pulse/s	300000 pulse
3	equivalent	20mm/s	40mm
	Pulse number	200000pulse/s	400000 pulse

Note:

1: when the pulse unit is pulse number, Y0 axis cumulative pulse register HSD0 (double word) is pulse numbers. When the pulse unit is equivalent, Y0 axis cumulative pulse register HSD0 (double word) is pulse numbers. Register HSD2(double word) is cumulative equivalent length.

2: when the pulse unit is equivalent, all the parameters will execute as equivalent, the length unit will transform to the equivalent unit, for example 1mm, then all the unit will transform as 1mm. and the unit of offset(1 rotate) should be same to pulse unit setting, for example, pulse unit is 0.1mm, offset is 6, which means the offset of one rotate is  $6 * 0.1 \text{mm} = 0.6 \text{mm}$ , and other unit related to length and speed will be 0.1mm or 0.1mm/s.

3: please note the max output frequency cannot over 200Khz when the pulse unit is equivalent.

4: fit for instruction PLSR, PLSF, ZRN.

- Interpolation coordinate mode

This parameter is not valid for now, no need to modify.

- Pulse send mode

It includes complete mode and continue mode.

Complete mode: it starts next segment of pulse when present segment pulse finishes.

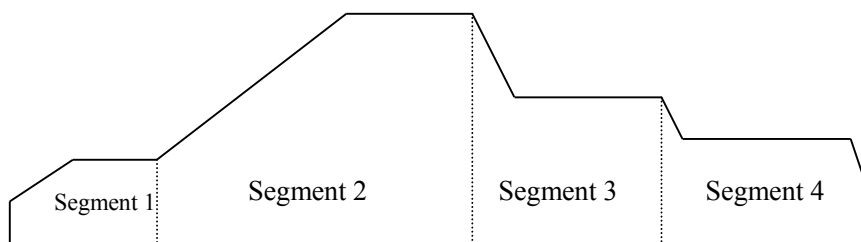

The pulse curve please refer to above diagram. Each segment will send the pulse numbers at setting speed. Except the last segment, each segment includes rising or falling part, stable part. The last segment includes rising part, falling part and stable part.

For example: the PLC needs to send four segments of pulse, segment 1 frequency is 1000Hz, pulse number is 2000, segment 2 frequency is 2000Hz, pulse number is 4000, segment 3 frequency is 3000Hz, pulse number is 6000, segment 4 frequency is 4000Hz, pulse number is 8000. It will send the pulse as complete mode, the curve please see below diagram.

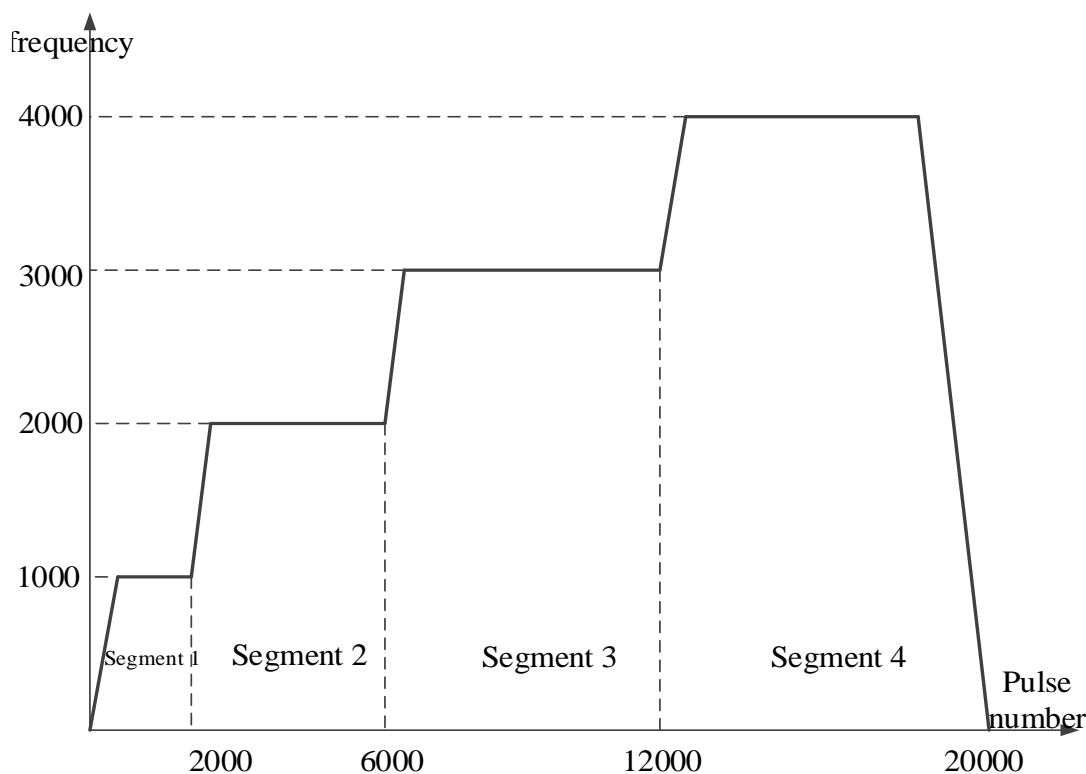

Continue mode: it already accelerates or decelerates to next segment when present segment pulse finishes sending.

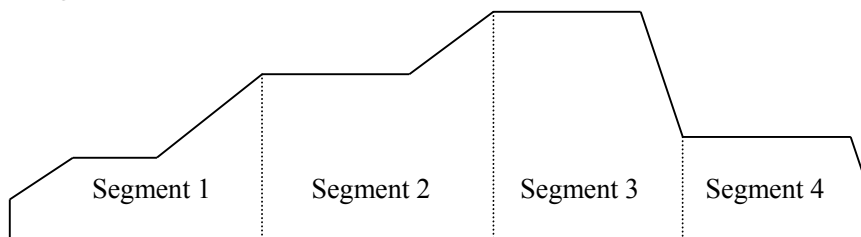

The pulse curve diagram is as the above. When the present segment finishes sending, it already

switch to next segment speed. Except segment 1, each segment includes stable part, rising part or falling part. Segment 1 includes rising part or falling part, stable part, rising or falling part.

For example: the PLC needs to send four segments of pulse, segment 1 frequency is 1000Hz, pulse number is 2000, segment 2 frequency is 2000Hz, pulse number is 4000, segment 3 frequency is 3000Hz, pulse number is 6000, segment 4 frequency is 4000Hz, pulse number is 8000. It will send the pulse as continue mode, the curve please see below diagram.

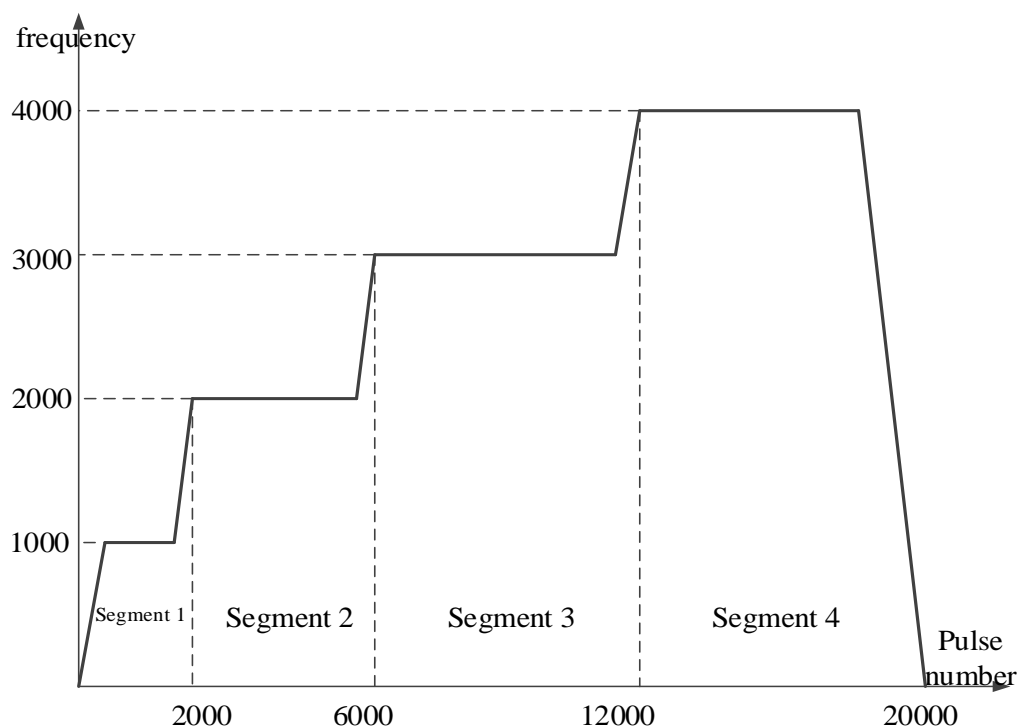

Note: the two modes are fit for instruction PLSR and PLSF.

- Pulse direction terminal

The pulse direction of PLSR needs to configure in the parameter table:

Y0 axis-Common-Offset (1)	1
Y0 axis-Common-Pulse direction terminal	Y no terminal
Y0 axis-Common-Delayed time of pulse direction (ms)	10

XD2, XD3, XD5 (except XD5-48T6/60T6) and XDC series transistor output PLC all have two channels of pulse output (Y0, Y1), the direction terminal can be any terminal except Y0 and Y1. XD5-48T6/60T6 has 6 channels of pulse output (Y0, Y1, Y2, Y3, Y4, Y5). XDM series has 4 channels or 10 channels pulse output (Y0, Y1, Y2, Y3 or Y0, Y1, Y2, Y3, Y4, Y5, Y6, Y7, Y10, Y11). The direction terminal can be any terminal except pulse output terminal.

The pulse output terminal uses high-speed optocoupler(response time below 5us), other terminals use normal optocoupler(response time below 0.2ms).

When Y0 is used to pulse output, and other pulse output terminals no need to output pulse, these terminals also can be pulse direction terminal. If Y0 no needs to output pulse, it also can be pulse direction terminal.

**Note:**

- 1: please do not choose the terminal over the actual output terminal number.
- 2: fit for PLSR, PLSF, ZRN.

- Delayed time of pulse direction

When it is sending forward direction pulse, it will set ON the direction terminal first, then output the pulse after the delay time. When it is sending reverse direction pulse, it will set OFF the direction terminal first, then output the pulse after the delay time.

Y0 axis-Common-Pulse direction terminal	Y no terminal
Y0 axis-Common-Delayed time of pulse direction (ms)	10
Y0 axis-Common-Gear clearance positive compensation	0

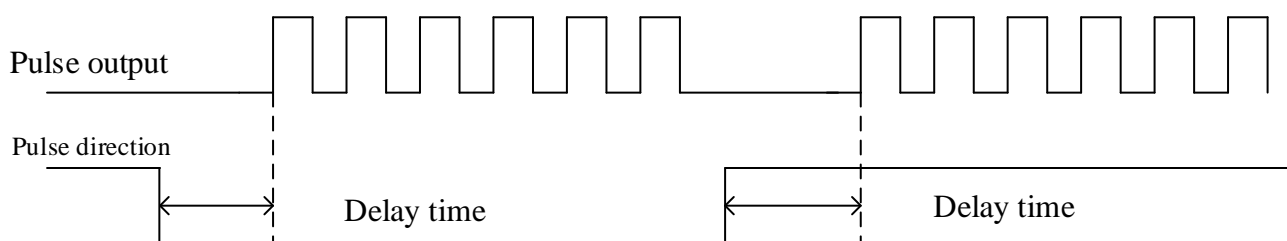
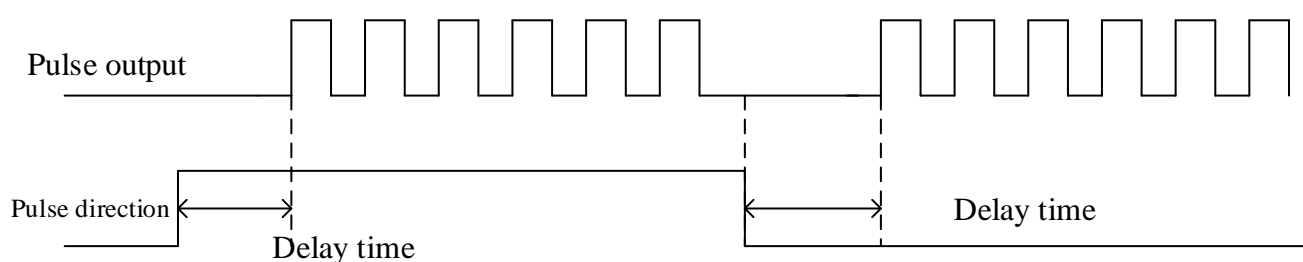

As the pulse output terminal is high-speed optocoupler(response time below 5us), other terminals are normal optocoupler(response time below 0.2ms)(such as XD3-32T-E) or relay output(about 10ms)(such as XD3-24R-E), the direction terminal will output after pulse terminal, so the direction terminal must be triggered first, then delay some time to output pulse. This can avoid the pulse error caused by direction switch lag(forward pulse switch to reverse pulse or reverse pulse switch to forward pulse).

The default pulse direction delay time is 10ms, user can adjust the time according to the terminal output type and scanning period(Y0 and Y1 response time is 5us, other transistor terminal is 0.2ms, relay output is 10ms).

Note: suitable for PLSR, PLSF, ZRN.

- Gear clearance positive compensation

When the work table finished reverse moving and switched to forward moving, there is clearance between table and ball screw, it will cause the actual moving distance is less than setting value, this parameter can delete this error.

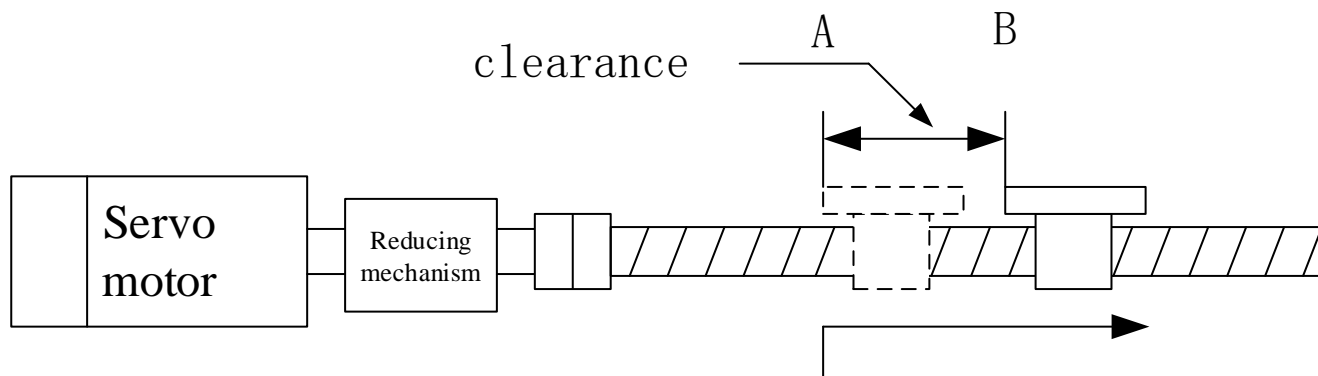

**Mechanical structure**

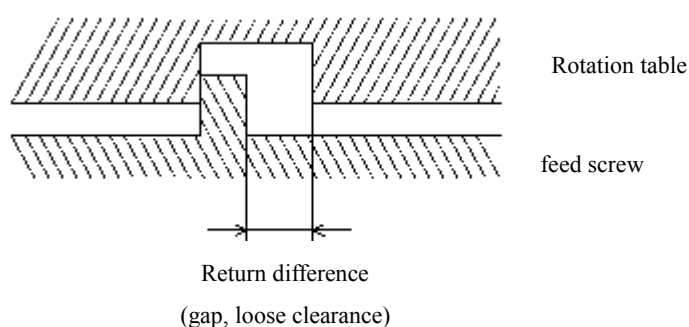

**Mechanical clearance structure**

The table moves from right to left, when the table left side moves to position A, it will stop and moves from left to right. As the ball screw clearance, it cannot move right for some pulses, and the actual moving distance is less than setting value. If there is no clearance, it will move from A to B. in order to delete the error, we must send some pulses before moving right, and then send the actual moving right pulses.

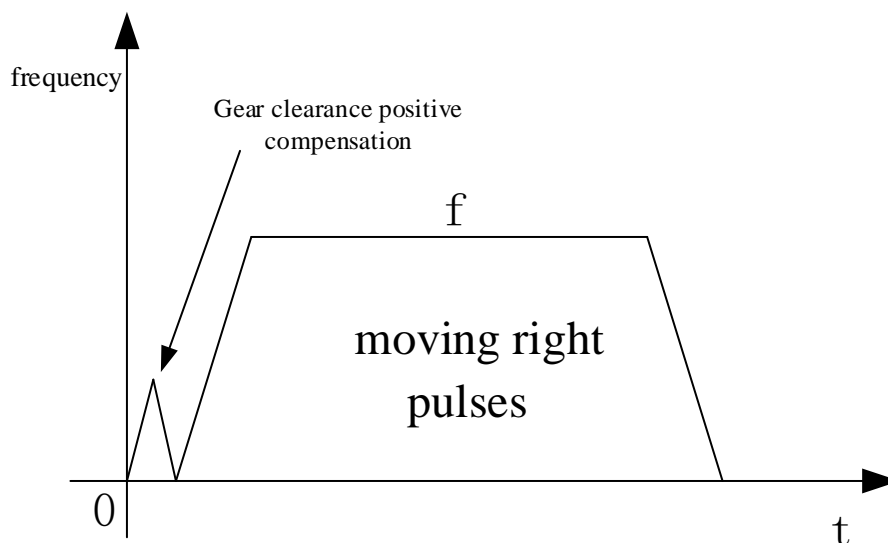
**Note:**

- ※1: it only execute the gear clearance positive compensation when the direction of last and present pulse segment is different.
- ※2: the gear clearance positive compensation pulses should output in separate segment, it cannot output in the same pulse segment of moving right pulses.
- ※3: the gear clearance positive compensation pulses will not be counted in pulse cumulative registers (such as HSD0 for Y0 output terminal).
- ※4: suitable for instruction PLSR, PLSF, ZRN.
- ※5: the unit of gear clearance positive compensation is decided by pulse unit.

- Gear clearance negative compensation

When the work table finished forward moving and switched to reverse moving, there is clearance between table and ball screw, it will cause the actual moving distance is less than setting value, this parameter can delete this error.

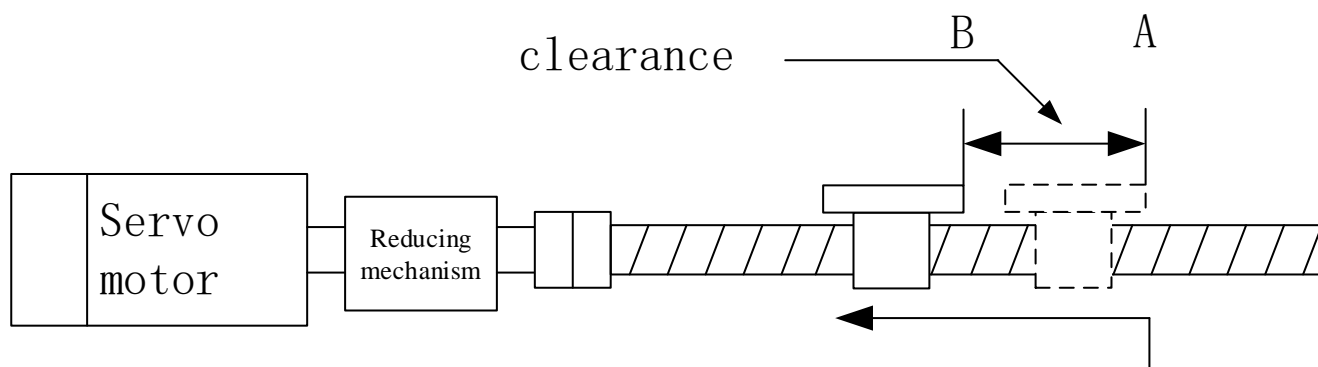
**Mechanical structure**

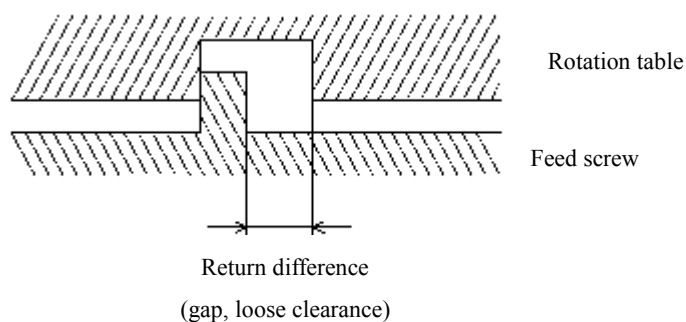

The table moves from left to right, when the table right side moves to position A, it will stop and moves from right to left. As the ball screw clearance, it cannot move left for some pulses, and the actual moving distance is less than setting value. If there is no clearance, it will move from A to B. in order to delete the error, we must send some pulses before moving left, and then send the actual moving left pulses.

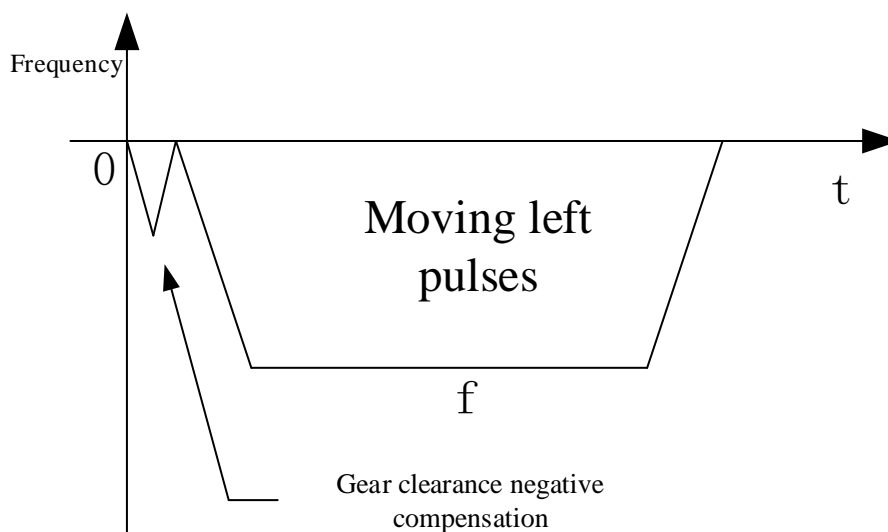

**Note:**

- ※1: it only execute the gear clearance negative compensation when the direction of last and present pulse segment is different.
- ※2: the gear clearance negative compensation pulses should output in separate segment, it cannot output in the same pulse segment of moving left pulses.
- ※3: the gear clearance negative compensation pulses will not be counted in pulse cumulative registers (such as HSD0 for Y0 output terminal).
- ※4: suitable for instruction PLSR, PLSF, ZRN.
- ※5: the unit of gear clearance negative compensation is decided by pulse unit.

- Electrical origin position

This parameter cannot modify.



- Signal terminal switch state-point switch state setting

It can set the state of the signal collection terminal. The terminal state can be normally open and normally close. The signal terminal includes origin point, Z phase switch, positive limit switch, negative limit switch.

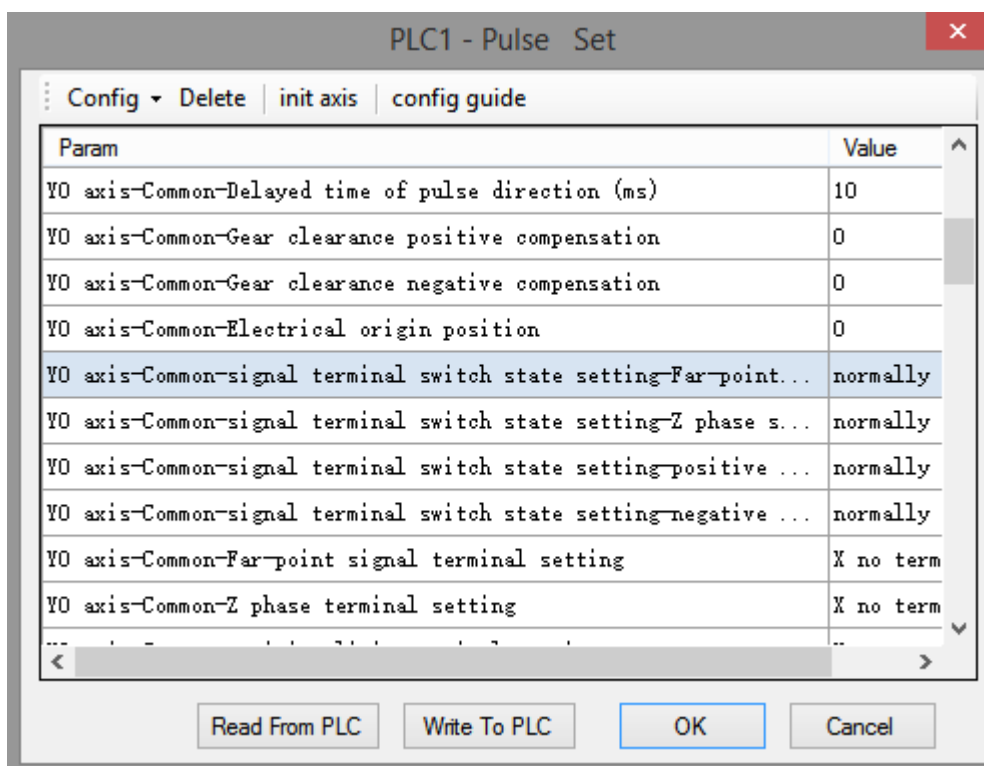

Take origin point as an example.

Normally open: the mechanical origin switch is normally open(OFF) when it returns origin, it will be ON when the machine touches the origin switch.

Normally close: the mechanical origin switch is normally close(ON) when it returns origin, it will be OFF when the machine touches the origin switch.

- Origin point signal terminal setting

The PLC input point of mechanical origin switch.

Y0 axis-Common-signal terminal switch state setting...	normally on
Y0 axis-Common-Far-point signal terminal setting	X no terminal
Y0 axis-Common-Z phase terminal setting	X no terminal
Y0 axis-Common-positive limit terminal setting	X no terminal

**Note:**

※1: the input point range cannot over actual input of PLC.

※2: only fit for mechanical return origin instruction ZRN.

※3: the origin point can be PLC input terminal, if the terminal is for external interruption input, the returning mechanical origin process will be operated as interruption and the precision will be improved (Z phase return origin has no effect). If the terminal is not for external interruption, the returning origin process will be affected by PLC scanning period (Z phase return origin has no effect).

※4: please refer to appendix 4 for details of external interruption terminal.

- Z phase terminal setting

When returning mechanical origin, it will move reverse slowly with slow speed and acceleration slop until reach origin creep speed, and it starts to count the Z phase signal at the moment of leaving the origin signal. Here can set the Z phase count input terminal.

Y0 axis-Common-Far-point signal terminal setting	X no terminal
Y0 axis-Common-Z phase terminal setting	X no terminal
Y0 axis-Common-positive limit terminal setting	X no terminal
Y0 axis-Common-negative limit terminal setting	X no terminal

**Note:**

※1: only fit for mechanical return origin instruction ZRN.

※2: Z phase terminal only can be PLC external interruption input. As the pulse width of Z phase signal outputting from servo drive is very narrow, normal PLC input filter time is 10ms, the Z phase signal only can be caught through high speed optical coupler input. If using normal terminal, it cannot catch the Z phase signal and cause returning mechanical origin error.

※3: Z phase input terminals:

PLC model	Z phase terminal setting
XD2-16/24/32/48/60	X2, X3, X4, X5, X6, X7
XD3-16/24/32/48/60	X2, X3, X4, X5, X6, X7
XD5-16	X2, X3, X4, X5, X6, X7
XD5-24/32/24T4/32T4/48T4/48D4T4/60T4	X2, X3, X4, X5, X6, X7, X10, X11, X12, X13
XD5-48/60/48T6/60T6/60T10	X2, X3, X4, X5, X6, X7, X10, X11, X12, X13
XDM-24T4/32T4	X2, X3, X4, X5, X6, X7, X10, X11, X12, X13
XDM-60T4/60T4L/60T10	X2, X3, X4, X5, X6, X7, X10, X11, X12, X13
XDC-24/32/48/60	X2, X3, X4, X5, X6, X7, X10, X11, X12, X13
XD5E-24/30/48/60/30T4/60T4/60T6/60T10	X2, X3, X4, X5, X6, X7, X10, X11, X12, X13
XDME-30T4/60T4/60T10	X2, X3, X4, X5, X6, X7, X10, X11, X12, X13
XDH-60T4	X2, X3, X4, X5, X6, X7, X10, X11, X12, X13
XL3-16	X2, X3, X4, X5, X6, X7
XL3-32	X2, X3, X4, X5, X6, X7, X10, X11, X12, X13
XL5-16	X2, X3, X4, X5, X6, X7
XL5-32/32T4	X2, X3, X4, X5, X6, X7, X10, X11, X12, X13
XL5E-16	X2, X3, X4, X5, X6, X7
XL5E-32T/32T4	X2, X3, X4, X5, X6, X7, X10, X11, X12, X13
XL5E-64T6	X2, X3, X4, X5, X6, X7, X10, X11, X12, X13
XLME-32T4	X2, X3, X4, X5, X6, X7, X10, X11, X12, X13

- Positive limit terminal setting

When the machine is returning origin (instruction ZRN), to prevent the table from moving beyond the range, the protection terminal is installed at both ends of the range. Please refer to ZRN instruction for details.

Y0 axis-Common-Z phase terminal setting	X no terminal
Y0 axis-Common-positive limit terminal setting	X no terminal
Y0 axis-Common-negative limit terminal setting	X no terminal
Y0 axis-Common-Zero clear CLR output setting	Y no terminal

When the instruction ZRN, PLSR, PLSF are executed, if the forward pulse touches positive limit, the pulse will stop in slow stop mode (make sure the positive limit switch is in triggered state after pulse stop). The pulse will be always prohibited when the positive limit switch is triggered, but the reverse pulse can be triggered.

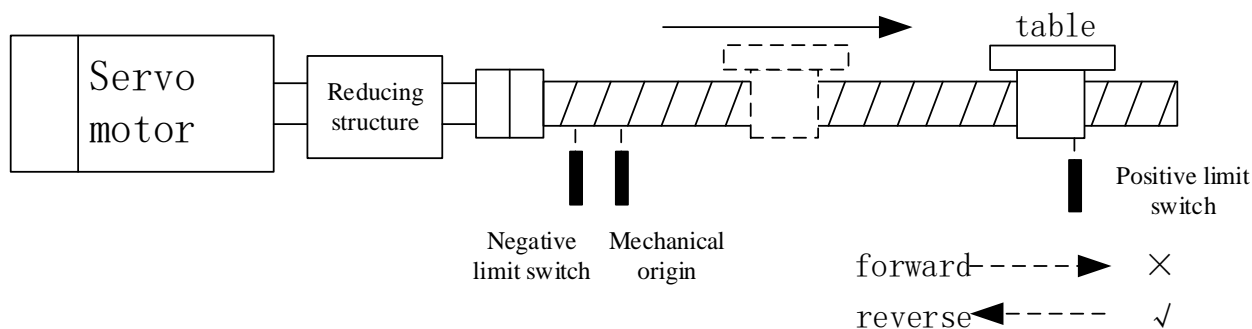

#### Notes:

- ※1: the input terminal cannot over the PLC actual input range.
- ※2: make sure the positive limit block is long enough, to ensure the positive limit switch is still triggered after pulse stop. Otherwise the table will strick the machine when the forward pulse is triggered again.
- ※3: fit for instruction PLSR, PLSF, ZRN.

- Negative limit terminal setting

When the machine is returning origin (instruction ZRN), to prevent the table from moving beyond the range, the protection terminal is installed at both ends of the range. Please refer to ZRN instruction for details.

Y0 axis-Common-positive limit terminal setting	X no terminal
Y0 axis-Common-negative limit terminal setting	X no terminal
Y0 axis-Common-Zero clear CLR output setting	Y no terminal
Y0 axis-Common-Return speed VH	0

When the instruction ZRN, PLSR, PLSF are executed, if the reverse pulse touches negative limit, the pulse will stop in slow stop mode (make sure the negative limit switch is in triggered state after pulse stop). The pulse will be always prohibited when the negative limit switch is triggered, but the forward pulse can be triggered.

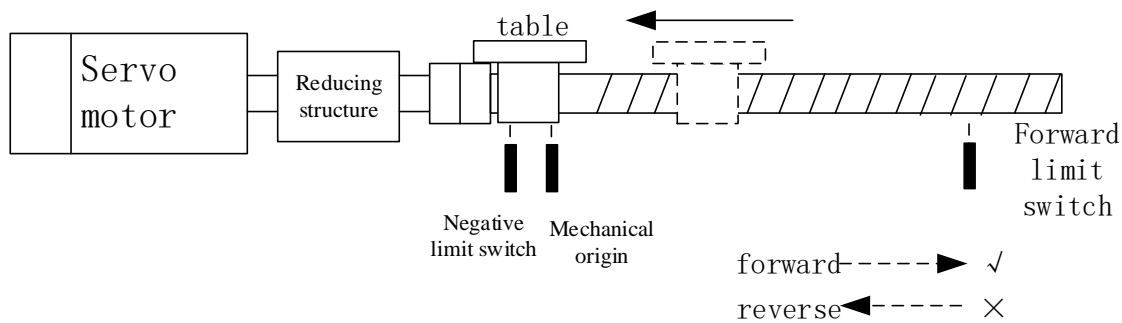

**Notes:**

- ※1: the input terminal cannot over the PLC actual input range.
- ※2: make sure the negative limit block is long enough, to ensure the negative limit switch is still triggered after pulse stop. Otherwise the table will strick the machine when the reverse pulse is triggered again.
- ※3: fit for instruction PLSR, PLSF, ZRN.

- Zero clear CLR output setting

It will output the signal after the returning mechanical origin ends. This signal can send to other device such as servo drive to clear the servo motor error counter, then copy the mechanical origin position to present position to finish the returning to zero process.

Y0 axis-Common-negative limit terminal setting	X no terminal
Y0 axis-Common-Zero clear CLR output setting	Y no terminal
Y0 axis-Common-Return speed VH	0
Y0 axis-Common-Creeping speed VC	0

- CLR signal delayed time

The CLR signal pulse width time, the unit is ms. The range is 0 to 32767 (default is 20ms).

Y0 axis-Common-Z phase num	0
Y0 axis-Common-CLR signal delayed time (ms)	20
Y0 axis-Common-grinding wheel radius(polar)	0
Y0 axis-Common-soft limit positive value	0

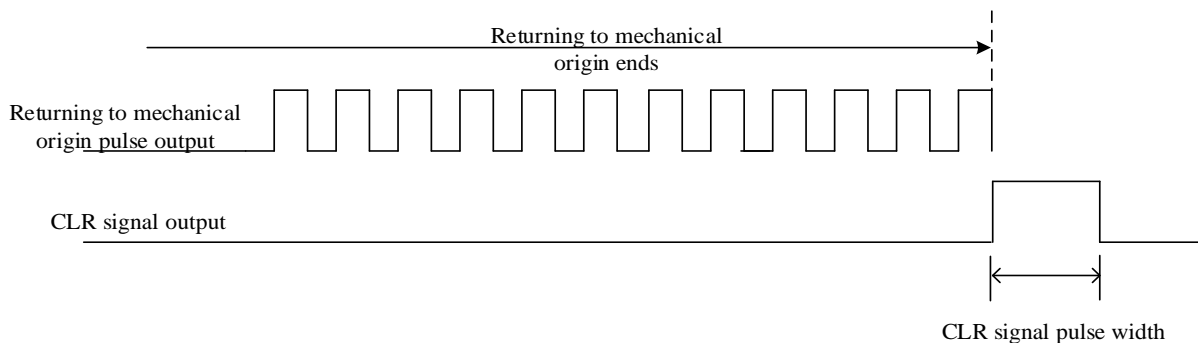

CLR signal diagram

**Notes:**

- ※1: only fit for instruction ZRN.
- ※2: please use PLC main unit output terminal for CLR signal output.
- ※3: please do not set too small CLR signal delay time, otherwise the servo drive cannot receive too narrow pulse width signal.

- Return speed VH

When it starts to run ZRN, the table accelerates to return speed VH and moves towards mechanical origin, this can shorten the returning time.

Y0 axis-Common-Zero clear CLR output setting	Y no terminal
Y0 axis-Common-Return speed VH	0
Y0 axis-Common-Creeping speed VC	0
Y0 axis-Common-Mechanical zero position	0

**Notes:**

- ※1: only fit for instruction ZRN.
- ※2: when the ZRN starts, VH accelerates as setting acceleration slop, then decelerates as setting deceleration slop when touching the near origin signal or origin signal.
- ※3: if there is no near origin signal, please do not set the VH speed too large, otherwise it will cause mechanical oscillation as the VH speed quickly decelerating to zero.
- ※4: if there is no near origin signal, please do not set the VH speed too large and deceleration slop too small, otherwise it will cause the table out of origin signal and even touching the reverse limit signal when decelerating to zero as the table decelerating time is too long.

- Creeping speed VC

When it meets the origin signal, the start speed decelerates to zero, after delay time, it reverse accelerates to creeping speed. It will stop the creeping speed at once when the work table leaves origin signal. As the stop position of work table leaving origin signal is mechanical origin, in order to improve mechanical origin precision, generally, the creeping speed is small.

Y0 axis-Common-Return speed VH	0
Y0 axis-Common-Creeping speed VC	0
Y0 axis-Common-Mechanical zero position	0

**Note:**

- ※1: only fit for instruction ZRN.
- ※2: the creeping speed acc/dec slope is same to setting acceleration/deceleration slope. It will urgent stop or count the Z phase pulse numbers when leaving origin signal.
- ※3: Do not set the creeping speed over 100r/min, otherwise it will affect the high precision returning to origin.
- ※4: Do not set the creeping speed larger than or equal to returning to origin speed VH.

- Mechanical zero position

The present position after returning to mechanical origin ends. Take axis Y0 as an example, set the present position value HSD0(double word) or HSD2(double word) after returning to mechanical

origin.

Generally, the present value of mechanical origin is 0, it also can be set to other value. After the returning to mechanical origin, the related cumulative pulse register will be updated to setting value.

Y0 axis-Common-Creeping speed VC	0
Y0 axis-Common-Mechanical zero position	0
Y0 axis-Common-Z phase num	0

Note:

※1: only fit for instruction ZRN.

※2: if the pulse unit of axis Y0 is set to pulse numbers, the mechanical origin setting value will be written in HSD0(double word) after returning to mechanical origin. If the pulse unit of axis Y0 is set to equivalent (1mm, 0.1mm, 0.01mm, 1um), the mechanical origin setting value will be written in HSD2(double word) after returning to mechanical origin.

- Z phase numbers

When it meets the origin signal, the start speed decelerates to zero, after delay time, it reverse accelerates to creeping speed. It can count the servo motor Z phase pulse when the work table leaves origin signal. It will stop creeping speed at once when the count value reaches setting Z phase pulse numbers, and mechanical returning to origin ends.

Y0 axis-Common-Mechanical zero position	0
Y0 axis-Common-Z phase num	0
Y0 axis-Common-CLR signal delayed time (ms)	20

Note:

※1: only fit for instruction ZRN.

※2: if the Z phase numbers is set to 0, it means Z phase pulse catching function is invalid, it will stop at once when leaving origin with creeping speed and returning to origin ends.

※3: please avoid the interval between work table leaving origin signal and Z phase signal is too short, otherwise the origin position will be error.

※4: Z phase signal maybe changed after install the servo motor again, please adjust it.

※5: if it is stepper motor, the external proximity switch signal can be used to Z phase signal.

- Grinding wheel radius(polar)

This parameter cannot be used right now.

Y0 axis-Common-CLR signal delayed time (ms)	20
Y0 axis-Common-grinding wheel radius(polar)	0
Y0 axis-Common-soft limit positive value	0

- Fast locate instruction default parameter block  
DRV, DRVI, DRVA instruction use this parameter block. The first set is used by default.

YO axis-Common-Rated speed corresponding frequency (100Hz) (...)	0
YO axis-Common-Positioning completion time limit (ms) (close...)	0
YO axis-Common-Fast locate instruction default parameter block	1
YO axis-Common-Interpolation instruction default parameter b...	2
YO axis-group 0-Pulse default speed	1000

Note: this parameter only works for v3.4.6b and higher normal PLC and v3.5.3b and higher Ethernet type PLC.

- Interpolation instruction default parameter block  
LIN, CW, CCW, ARC and other interpolation instruction use this parameter block. The second set is used by default.

YO axis-Common-Positioning completion time limit (ms) (close...)	0
YO axis-Common-Fast locate instruction default parameter block	1
YO axis-Common-Interpolation instruction default parameter b...	2
YO axis-group 0-Pulse default speed	1000

Note: this parameter only works for v3.4.6b and higher normal PLC and v3.5.3b and higher Ethernet type PLC.

### Group 1 parameters (group 0, 2, 3, 4 parameters please refer to group 1)

Note:

\*1: The group 0 parameters is only supported by ordinary PLC with firmware version v3.4.6b and above or Ethernet PLC with firmware version v3.5.3b and above.

\* 2: When the user needs to frequently change the default speed, acceleration and deceleration time and other parameters, it is recommended to use group 0 parameters.

- Pulse default speed/acceleration time of default pulse speed/deceleration time of default pulse speed(ms)

The three parameters and initial speed, stop speed are used to define the pulse acceleration and deceleration slop.

Acceleration slope = (pulse default speed-0)/ acceleration time of default pulse speed

Deceleration slope = (pulse default speed-0)/ deceleration time of default pulse speed

The unit of [default pulse speed] is still determined by whether the [pulse unit] is the number of pulses or equivalent (1 mm, 0.1 mm, 0.01 mm, 1 um) (that is, when the pulse unit is the number of pulses, the setting parameter unit is Hz; When the pulse unit is equivalent, the setting parameter is length.)

YO axis-group 1-Pulse default speed	0
YO axis-group 1-Acceleration time of Pulse default s...	0
YO axis-group 1-Deceleration time of pulse default s...	0

#### Example 1:

When the pulse unit is pulse numbers, pulse default speed is 1000Hz, acceleration time of pulse default speed is 100ms, deceleration time of pulse default speed is 200ms, initial speed is 0Hz, stop speed is 0Hz, it means the pulse frequency takes 100ms to increase 1000Hz and takes 200ms to decrease 1000Hz. If it accelerates from 0Hz to 5000Hz, the time is  $5000/1000*100=500\text{ms}$ , if it decelerates from 5000Hz to 0Hz, the time is  $5000/1000*200=1000\text{ms}$ .

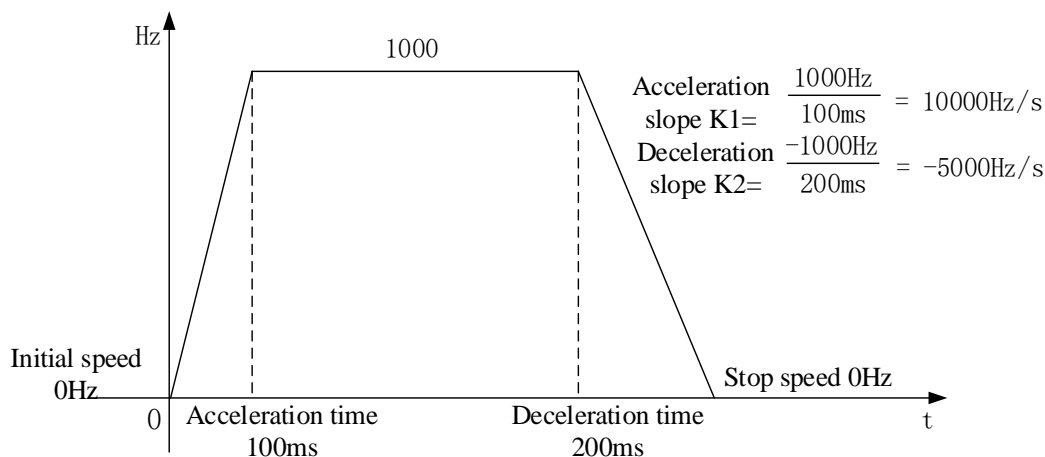

### Example 2:

When the pulse unit is pulse numbers, pulse default speed is 1000Hz, acceleration time of pulse default speed is 100ms, deceleration time of pulse default speed is 200ms, initial speed is 100Hz, stop speed is 200Hz, it means the pulse frequency takes 100ms to increase  $(1000-100)=900\text{Hz}$  and takes 200ms to decrease  $(1000-200)=800\text{Hz}$ . If it accelerates from 0Hz to 5000Hz, the time is  $5000/900*100=555\text{ms}$ , if it decelerates from 5000Hz to 0Hz, the time is  $5000/800*200=1250\text{ms}$ .

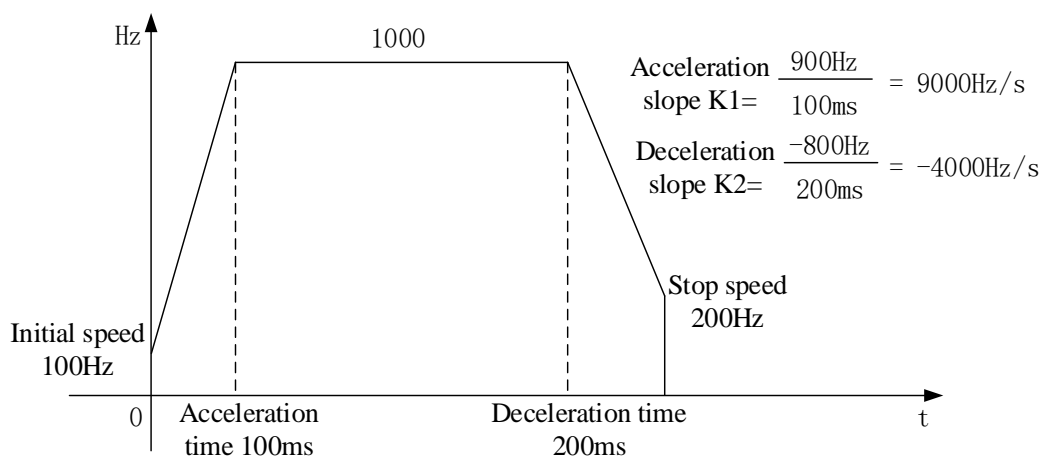

### Example 3:

When the pulse unit is equivalent 1mm, pulse default speed is 10mm/s, acceleration time of pulse default speed is 100ms, deceleration time of pulse default speed is 200ms, initial speed is 0mm/s, stop speed is 0mm/s, it means the pulse frequency takes 100ms to increase 10mm/s and takes 200ms to decrease 10mm/s. If it accelerates from 0 to 50mm/s, the time is  $50/10*100=500\text{ms}$ , if it decelerates from 50mm/s to 0, the time is  $50/10*200=1000\text{ms}$ .

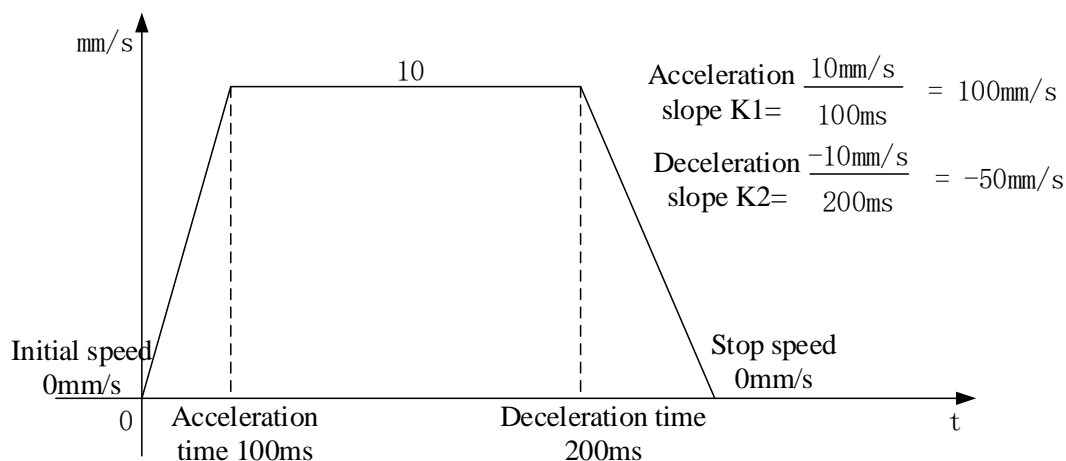

**Example 4:**

When the pulse unit is equivalent 1mm, pulse default speed is 10mm/s, acceleration time of pulse default speed is 100ms, deceleration time of pulse default speed is 200ms, initial speed is 1mm/s, stop speed is 2mm/s, it means the pulse frequency takes 100ms to increase  $(10-1)=9\text{mm/s}$  and takes 200ms to decrease  $(10-2)=8\text{mm/s}$ . If it accelerates from 0 to 50mm/s, the time is  $50/9*100=555\text{ms}$ , if it decelerates from 50mm/s to 0, the time is  $50/8*200=1250\text{ms}$ .

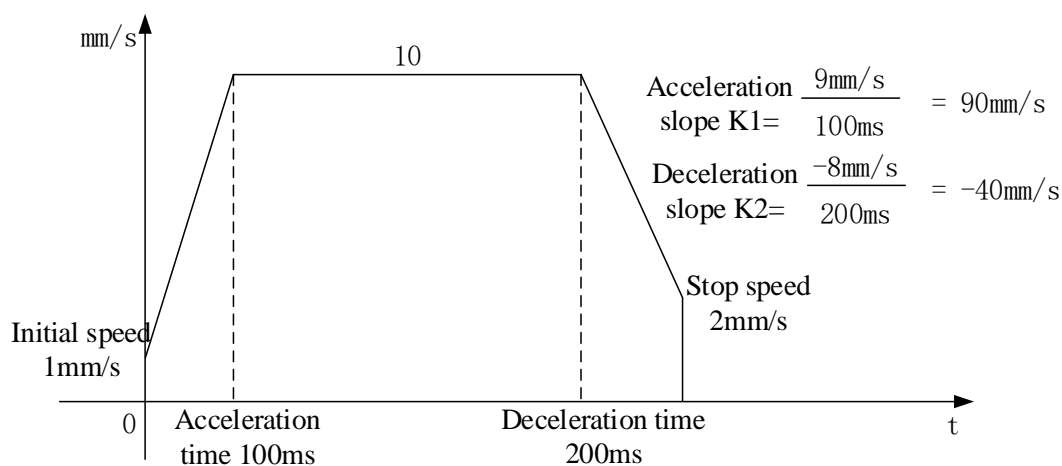
**Note:**

- ※1: the three parameters and initial speed, stop speed are used to define the acceleration and deceleration slope.
- ※2: the pulse acceleration slope is determined by the time accelerating from initial speed to default pulse speed, the pulse deceleration slope is determined by the time decelerating from default pulse speed to stop speed.
- ※3: the parameter is fit for instruction PLSR, PLSF, DRVI, DRVA, ZRN.
- ※4: initial speed and stop speed must be less than rated speed.
- ※5: the pulse default speed is not related to the pulse frequency, it is only used to set the acceleration and deceleration slope. But when the pulse frequency is 0, it will output pulse as the default pulse speed.

- Acceleration and deceleration time (ms)

This time is for gear clearance positive and negative compensation. This acceleration and deceleration time is same whatever how many is the gear clearance compensation quantity, the unit is ms.

Y0 axis-group 1-Deceleration time of pulse default s...	0
Y0 axis-group 1-Acceleration and deceleration time (ms)	0
Y0 axis-group 1-pulse acc/dec mode	linear acc/dec
Y0 axis-group 1-Max speed	0

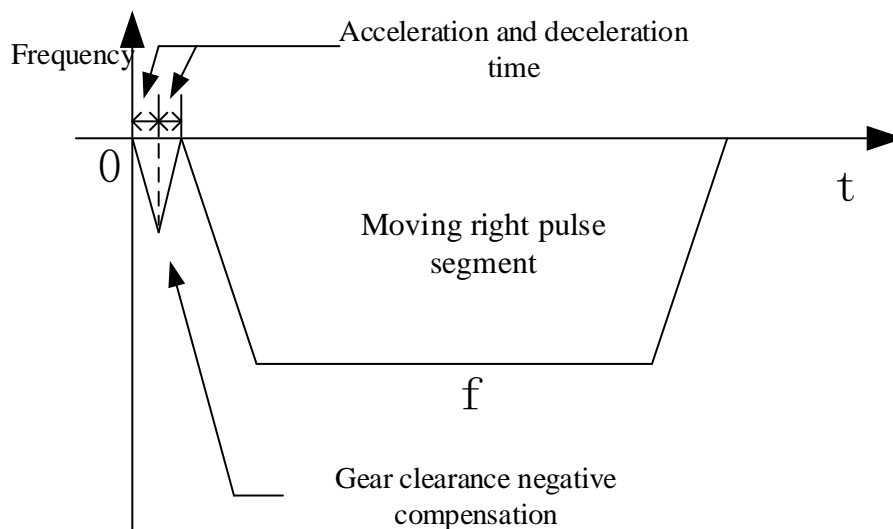
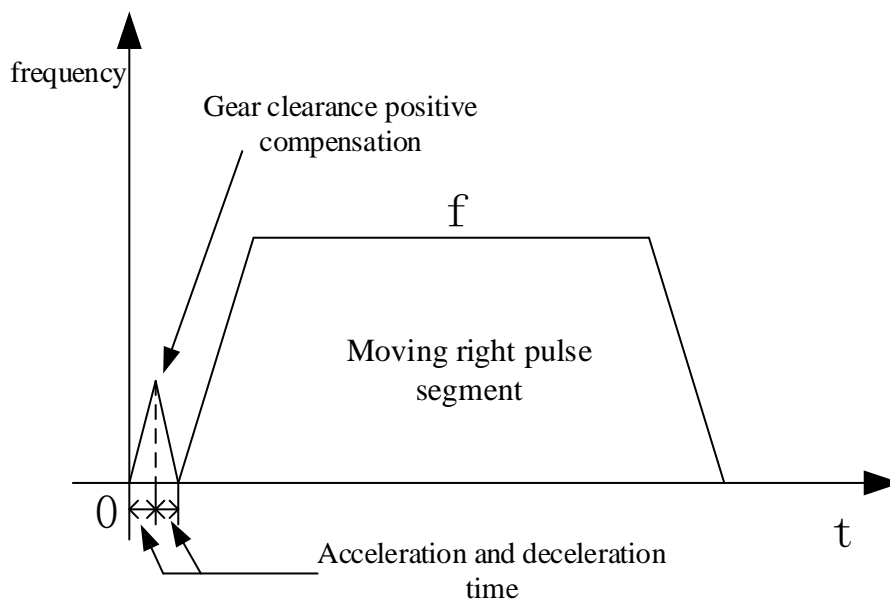

**Note:**

※1: the acceleration time and deceleration time is same.

※2: the acceleration and deceleration time is fixed value whatever how many is the gear

clearance compensation.

※3: this parameter is fit for instruction PLSR, PLSF, DRVI, DRVA, ZRN.

- Pulse acc/dec mode

The pulse acceleration mode accelerating from initial speed to setting frequency and pulse deceleration mode decelerating from setting frequency to initial speed.

Y0 axis-group 1-Deceleration time of pulse default s...	0
Y0 axis-group 1-Acceleration and deceleration time (ms)	0
Y0 axis-group 1-pulse acc/dec mode	linear acc/dec
Y0 axis-group 1-Max speed	0
Y0 axis-group 1-Initial speed	0

The pulse acc/dec mode include linear mode, S curve mode and sine curve mode.

Linear mode: the speed changing for accelerating or decelerating is line.

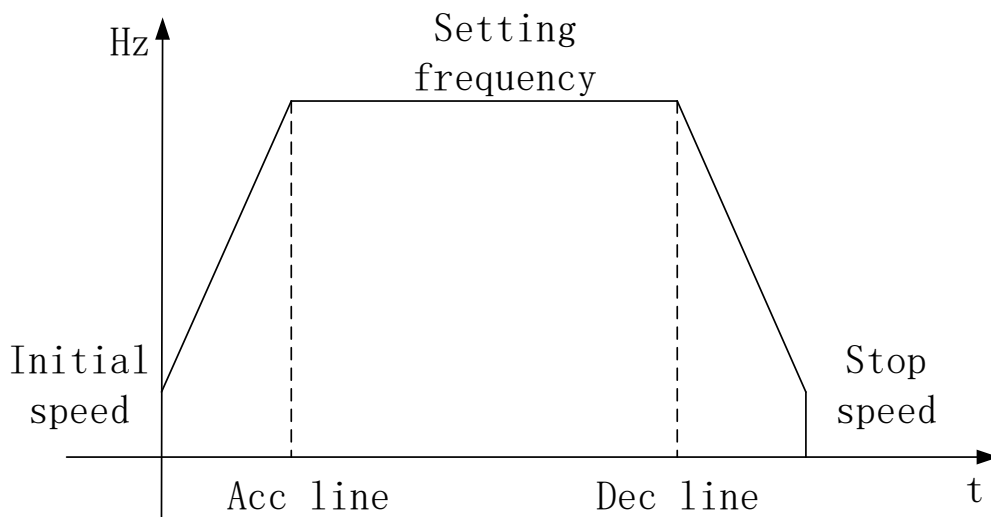

S-curve mode: the speed changing for accelerating or decelerating is S-curve.

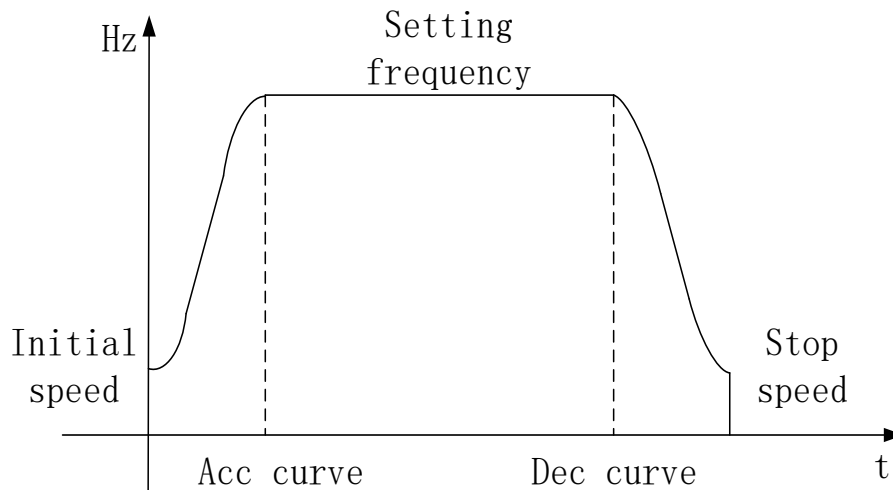

Sine curve mode: the speed changing for accelerating or decelerating is sine curve.

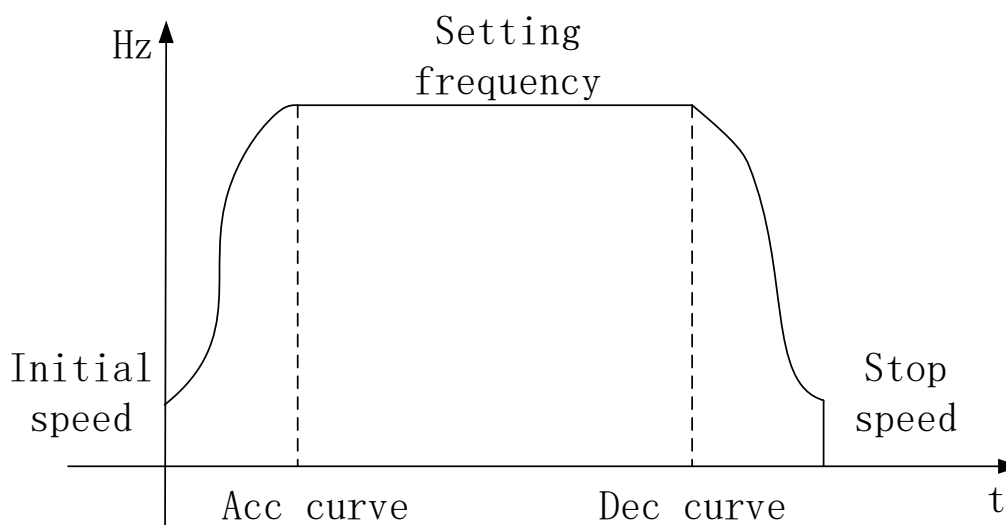

Sine-curve mode is fit for the receiving of stepper motor and servo motor and improve the run performance of stepper motor and servo motor. The details please refer to S-curve acceleration and deceleration.

Note: this parameter is fit for the instruction PLSR, PLSF, ZRN.

- Max speed

When all the pulse instructions in the program is executing parameter group 1, the highest pulse frequency cannot over the max speed, if it is over the max speed, PLC will run as the max speed.

Y0 axis-group 1-Acceleration and deceleration time (ms)	0
Y0 axis-group 1-pulse acc/dec mode	linear acc/dec
Y0 axis-group 1-Max speed	0
Y0 axis-group 1-Initial speed	0
Y0 axis-group 1-stop speed	0

**Note:**

- ※1: the max speed unit is changing as pulse unit(pulse number or equivalent).
- ※2: XD all series PLC pulse output frequency max speed is 200Khz. The max speed cannot over this value.
- ※3: when the pulse unit is equivalent, the transformed pulse frequency maybe very large and over max speed, please pay attention.
- ※4: User must set the max speed when using pulse instruction, otherwise the pusle cannot output normally.
- ※5: this parameter is fit for instruction PLSR, PLSF, ZRN.

- Initial speed and stop speed

The pulse start frequency and end frequency for the pulse instruction start and completion.

Generally, the initial and stop speed is 0, but for some special occasions, the pulse needs to start with non-zero speed and complete with non-zero speed.

Y0 axis-group 1-pulse acc/dec mode	linear acc/dec
Y0 axis-group 1-Max speed	0
Y0 axis-group 1-Initial speed	0
Y0 axis-group 1-stop speed	0
Y0 axis-group 1-FOLLOW performance param(1-100)	50

For example, it needs to output 30000 pulses, and accelerates from 1000Hz, takes 100ms to reach 5000Hz. And it decelerates from 5000Hz, takes 50ms to reach 2000Hz, and the pulse will complete here. The configuration is shown as below:

Y0 axis-group 1-Max speed	200000
Y0 axis-group 1-Initial speed	1000
Y0 axis-group 1-stop speed	2000

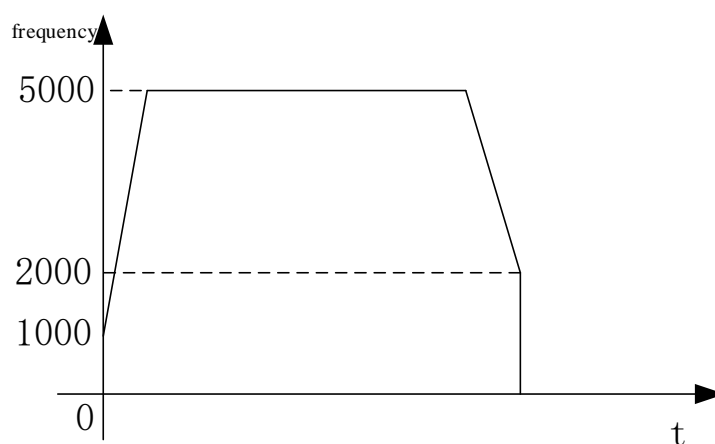

**Note:**

- ※1: the pulse unit of initial speed and stop speed is changing as the pulse number or equivalent.
- ※2: the initial speed and stop speed must be less than the max speed.
- ※3: when the pulse unit is equivalent, the transformed pulse frequency maybe very large and over max speed, please pay attention.
- ※4: make sure to set the initial speed and stop speed for pulse instruction, the default value is 0.
- ※5: this parameter is fit for instruction PLSR, PLSF, ZRN.

- Follow parameters

The FOLLOW instruction can make the slave axis servo motor or stepper motor following the master axis motor motion (which means the slave axis motion is consistent with main axis). The parameters include FOLLOW performance and FOLLOW feedforward compensation.

The FOLLOW instruction is motion following function, it can control the servo or stepper motor by outputting pulse according to motor encoder feedback.

FOLLOW performance: the function is similar to servo drive rigidity function. The smaller the value, the smaller the follow rigidity (delay time is long), the larger the value, the larger the follow rigidity (delay time is short).

FOLLOW feedforward compensation: there is delay time from receiving pulse to outputting pulse. In order to reduce the delay time, it can set the feedforward compensation, make the pulse a little

advanced. But if the feedforward parameter is too large, it will enter infinite loop, the motor will vibrate when the follow process ends.

YO axis-group 1-stop speed	2000
YO axis-group 1-FOLLOW performance param(1-100)	50
YO axis-group 1-FOLLOW forward compensation(0-100)	0
YO axis-group 2-Pulse default speed	0

- Pulse frequency refresh time

This time can be set by user, 100us or 1ms optional, the default is 1ms refresh time.

YO axis-group 1-FOLLOW forward compensation(0-100)	0
YO axis-group 1-Pulse frequency refresh time	1 ms refresh
YO axis-group 1-ZRN regression velocity VH	0

- ZRN regression velocity VH

This parameter is same to [common parameter—return speed VH], this parameter is preferred.

YO axis-group 1-Pulse frequency refresh time	1 ms refresh
YO axis-group 1-ZRN regression velocity VH	0
YO axis-group 1-ZRN crawl speed VC	0

Note: this parameter is only valid for PLC firmware v3.4.6 and above.

- ZRN crawl speed VC

This parameter is same to [common parameter—creeping speed VC], this parameter is preferred.

YO axis-group 1-ZRN regression velocity VH	0
YO axis-group 1-ZRN crawl speed VC	0
YO axis-group 2-Pulse default speed	1000

Note: this parameter is only valid for PLC firmware v3.4.6 and above.

#### 1-2-1-4. Pulse interruption flag

Pulse instruction PLSR can set up to 100 segments of pulse. It can produce a interruption flag after each pulse segment completion.

Note: each pulse segment has only one related interruption flag, whatever how is the pulse configuration jump setting, the interruption flag will be executed when this pulse segment is running.

Interruption flag for each pulse segment:

Interruption flag	Pulse axis	Notes
I60**(I6000~I6099)	PLS+0 (pulse)	Y0 axis 100 pulse segments interruption
I61**(I1000~I6199)	PLS+1 (pulse)	Y1 axis 100 pulse segments interruption
I62**(I6200~I6299)	PLS+2 (pulse)	Y2 axis 100 pulse segments interruption
I63**(I6300~I6399)	PLS+3 (pulse)	Y3 axis 100 pulse segments interruption

I64**(I6400~I6499)	PLS+4 (pulse)	Y4 axis 100 pulse segments interruption
I65**(I6500~I6599)	PLS+5 (pulse)	Y5 axis 100 pulse segments interruption
I66**(I6600~I6699)	PLS+6 (pulse)	Y6 axis 100 pulse segments interruption
I67**(I6700~I6799)	PLS+7 (pulse)	Y7 axis 100 pulse segments interruption
I68**(I6800~I6899)	PLS+8 (pulse)	Y8 axis 100 pulse segments interruption
I69**(I6900~I6999)	PLS+9 (pulse)	Y9 axis 100 pulse segments interruption

**Example 1:**

Now PLC has 8 pulse segments and executes from the first segment, the pulse output terminal is Y0, the interruption is shown as below:

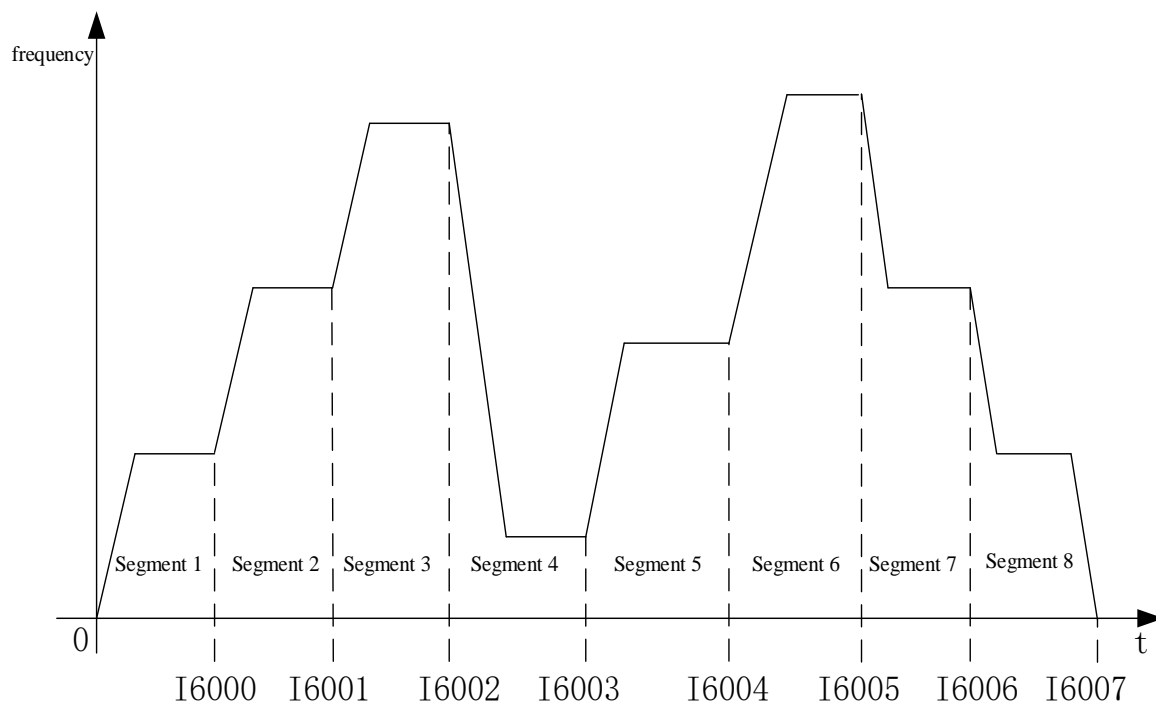
**Example 2:**

The PLC has 6 pulse segments, the pulse output terminal is Y0, but the pulse is not continuous outputting.

multi section pulse output

data start address:	HD0	user params address:	HD100	system params:	K1	output:	Y0
mode:	relative	start execute section count:	0	Config			

Add Delete | Upwards Downwards

	frequence	pulse count	wait condition	wait register	jump register
1	1000	1000	pulse sending complete	K0	K3
2	2000	2000	pulse sending complete	K0	K6
3	3000	3000	pulse sending complete	K0	K5
4	4000	4000	pulse sending complete	K0	K0
5	5000	5000	pulse sending complete	K0	K2
▶ 6	6000	6000	pulse sending complete	K0	K4

used space: HD0-HD69,HD100-HD103

Read From PLC Write To PLC OK Cancel

As the pulse configuration table, the pulse outputting sequence is segment 1, 3, 5, 2, 6, 4. The interruption flag is I6000, I6002, I6004, I6001, I6005, I6003, please see below diagram:

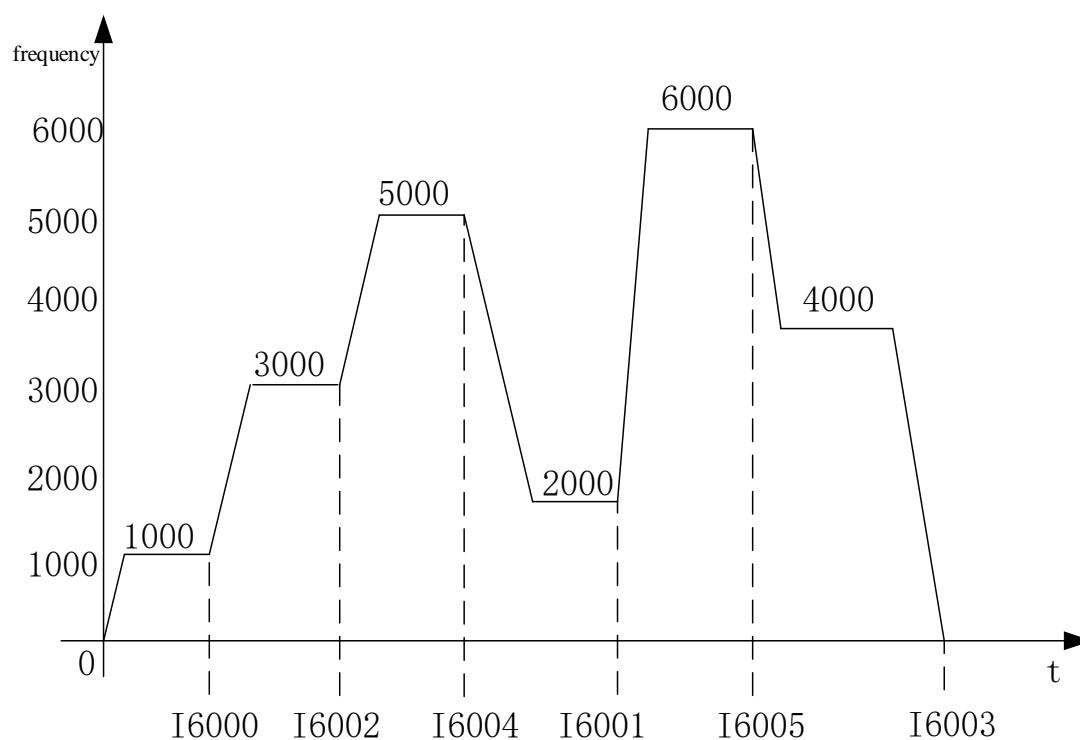

**Note: the program format is same for pulse interruption and external interruption.**



Main program

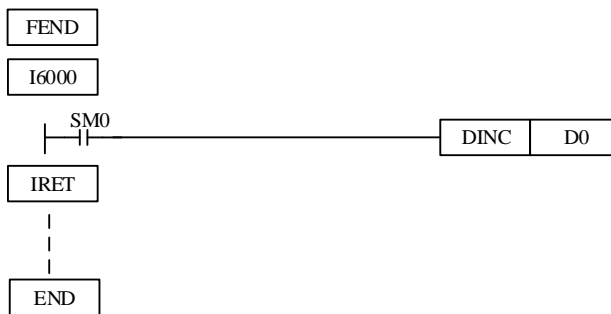

### 1-2-1-5. Pulse monitoring coil and register

#### ➤ Pulse sending flag

No.	Coil	Axis no.	Note
1	SM1000	PULSE_1	<p>The coil is ON when the pulse is sending, the coil will be OFF when the pulse sending ends.</p> <p>The falling edge of coil can judge whether the pulse sending is completed.</p>
2	SM1020	PULSE_2	
3	SM1040	PULSE_3	
4	SM1060	PULSE_4	
5	SM1080	PULSE_5	
6	SM1100	PULSE_6	
7	SM1120	PULSE_7	
8	SM1140	PULSE_8	
9	SM1160	PULSE_9	
10	SM1180	PULSE_10	

#### ➤ Pulse sending direction flag

No.	Coil	Axis no.	Note
1	SM1001	PULSE_1	<p>When the pulse number is positive value and forward direction, the coil is ON, when the pulse number is negative value and reverse direction, the coil is OFF.</p>
2	SM1021	PULSE_2	
3	SM1041	PULSE_3	
4	SM1061	PULSE_4	
5	SM1081	PULSE_5	
6	SM1101	PULSE_6	
7	SM1121	PULSE_7	
8	SM1141	PULSE_8	
9	SM1161	PULSE_9	
10	SM1181	PULSE_10	

#### ➤ High speed pulse special register HSD (latched)

No.	Function	Note	Axis no.
HSD0	Cumulative pulses low 16-bit	The unit is pulse number	PULSE_1
HSD1	Cumulative pulses high 16-bit		
HSD2	Cumulative pulses low 16-bit	The unit is equivalent	PULSE_2
HSD3	Cumulative pulses high 16-bit		
HSD4	Cumulative pulses low 16-bit	The unit is pulse number	PULSE_3
HSD5	Cumulative pulses high 16-bit		
HSD6	Cumulative pulses low 16-bit	The unit is equivalent	PULSE_4
HSD7	Cumulative pulses high 16-bit		
HSD8	Cumulative pulses low 16-bit	The unit is pulse number	PULSE_5
HSD9	Cumulative pulses high 16-bit		
HSD10	Cumulative pulses low 16-bit	The unit is equivalent	PULSE_6
HSD11	Cumulative pulses high 16-bit		
HSD12	Cumulative pulses low 16-bit	The unit is pulse number	PULSE_7
HSD13	Cumulative pulses high 16-bit		
HSD14	Cumulative pulses low 16-bit	The unit is equivalent	PULSE_8
HSD15	Cumulative pulses high 16-bit		
HSD16	Cumulative pulses low 16-bit	The unit is pulse number	PULSE_9
HSD17	Cumulative pulses high 16-bit		
HSD18	Cumulative pulses low 16-bit	The unit is equivalent	PULSE_10
HSD19	Cumulative pulses high 16-bit		
HSD20	Cumulative pulses low 16-bit	The unit is pulse number	PULSE_1
HSD21	Cumulative pulses high 16-bit		
HSD22	Cumulative pulses low 16-bit	The unit is equivalent	PULSE_2
HSD23	Cumulative pulses high 16-bit		
HSD24	Cumulative pulses low 16-bit	The unit is pulse number	PULSE_3
HSD25	Cumulative pulses high 16-bit		
HSD26	Cumulative pulses low 16-bit	The unit is equivalent	PULSE_4
HSD27	Cumulative pulses high 16-bit		
HSD28	Cumulative pulses low 16-bit	The unit is pulse number	PULSE_5
HSD29	Cumulative pulses high 16-bit		
HSD30	Cumulative pulses low 16-bit	The unit is equivalent	PULSE_6
HSD31	Cumulative pulses high 16-bit		
HSD32	Cumulative pulses low 16-bit	The unit is pulse number	PULSE_7
HSD33	Cumulative pulses high 16-bit		
HSD34	Cumulative pulses low 16-bit	The unit is equivalent	PULSE_8
HSD35	Cumulative pulses high 16-bit		
HSD36	Cumulative pulses low 16-bit	The unit is pulse number	PULSE_9
HSD37	Cumulative pulses high 16-bit		
HSD38	Cumulative pulses low 16-bit	The unit is equivalent	PULSE_10

---

HSD39	Cumulative pulses high 16-bit		
-------	-------------------------------	--	--

## 1-2-2. Multi-segment pulse output [PLSR]

### ◆ Instruction overview

Multi-segment pulse output instruction.

Multi-segment pulse output [PLSR]			
16-bit	-	32-bit	PLSR
Execution condition	Rising /falling edge of the coil	Suitable model	XD, XL (except XD1, XL1)
Hardware	-	Software	-

### ◆ Operand

Operand	Function	Type
S0	Pulse data start address	32-bit double word
S1	User parameter start address	32-bit double word
S2	System parameter start address (1 to 4)	32-bit double word
D	Pulse output terminal	Bit

### ◆ Suitable soft component

Word	Operand	System								Constant	Module	
		D*	FD	TD*	CD	DX	DY	DM*	DS*	K/H	ID	QD
	S0	•	•	•	•	•	•	•	•			
	S1	•	•	•	•	•	•	•	•			
	S2	•	•							•		

  

Bit	Operand	System						
		X	Y	M*	S*	T*	C*	Dnm
	D		•					

\*Note: D means D, HD. TD means TD, HTD. CD means CD, HCD, HSCD, HSD. DM means DM, DHM. DS means DS, DHS. M means M, HM, SM. S means S, HS. T means T, HT. C means C, HC.

### Function and action

instruction format

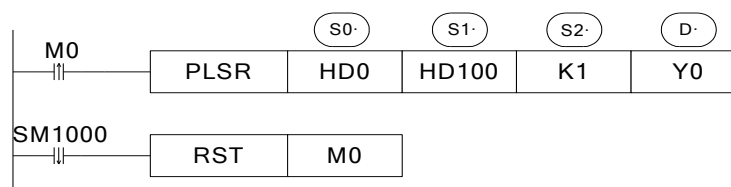

- S0 【data start address】 refer to chapter 1-2-1-1
- S1 【user parameter start address】 refer to chapter 1-2-1-2
- S2 【system parameter group】 K1~K4, refer to 1-2-1-3
- D 【pulse output terminal】 refer to chapter 1-1
- Pulse frequency range: 1Hz~100KHz. The value increasing means acceleration, the value

decreasing means deceleration, it is not related to the pulse direction.

- Pulse number: K-2,147,483,648 ~ K2,147,483,647, negative value means reverse direction. The acceleration and deceleration is set in system parameters, refer to chapter 1-2-1-3.
- When M0 is from OFF to ON, PLC executes the instruction PLSR, even M0 is cut off, the pulse will keep sending until end.
- If it needs to stop the pulse outputting, please use the instruction STOP.
- When the pulse is sending, the pulse sending flag of Y0 axis SM1000 is ON, when the pulse sending ends, SM1000 is OFF.
- Y0 cumulative pulse numbers are saved in HSD0(double word), the present pulse numbers are saved in SD1002(double word), more details please refer to chapter 6-5.
- For the instruction PLSR, if the frequency is changed when the pulse is sending, it will be effective at once. Other parameters will not be effective at once after changing, but be effective when the condition triggering next time.
- **In absolute mode, if the pulse numbers and cumulative pulse numbers(HSD0) is equal, SM1000 has no action, there is no falling edge.**

**Instruction mode**

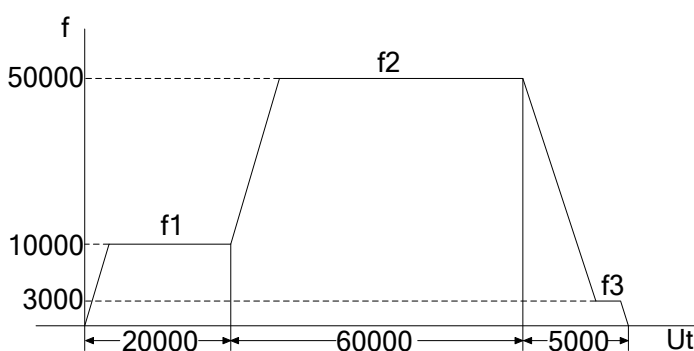

**Pulse curve**

multi section pulse output

data start address: HD0 user params address: HD100 system params: K1 output: Y0

mode: relative start execute section count: 0 Config

	frequency	pulse count	wait condition	wait register	jump register
1	10000	20000	pulse sending complete	K0	K0
2	50000	60000	pulse sending complete	K0	K0
▶ 3	3000	5000	pulse sending complete	K0	K0

used space: HD0-HD39,HD100-HD103

Read From PLC Write To PLC OK Cancel

**Pulse instruction parameter configuration table**

**How to do**

The following curves are set the parameters when the acceleration time is 0.

(1) Pulse segment completion mode division

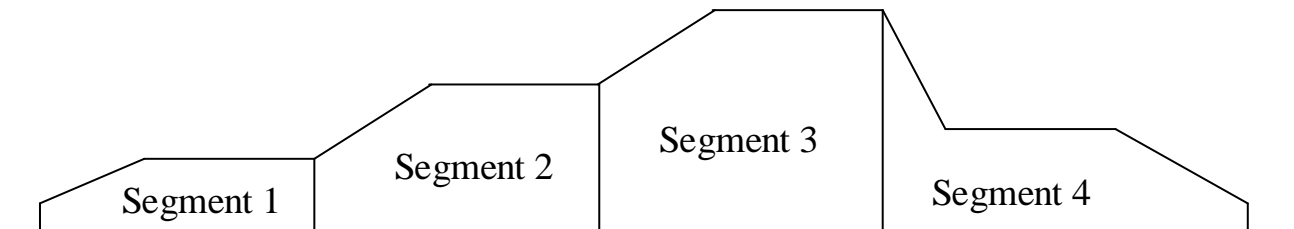

- The segment are divided as above diagram
- Except the last segment, all the segments include rising, stable and falling part.
- The last segment includes rising or falling, stable and rising or falling part.

(2) Pulse segment subsequent mode division

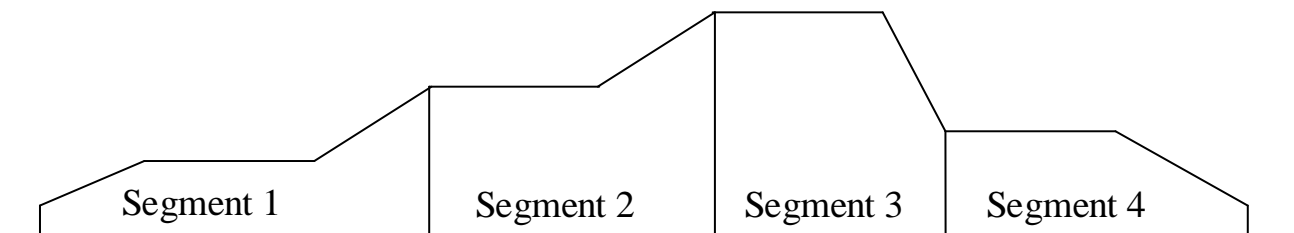

- The segment subsequent mode curve is shown as above diagram.
- It already switched to next segment speed when present segment ends. Except the first segment, other segments include stable part, rising or falling part.
- The first segment includes rising part or falling part, stable part, rising part or falling part.

(3) Single segment pulse curve

- The pulse numbers are enough

The pulse can reach the setting max frequency, the curve is trapezoid.



- The pulse numbers are not enough  
The pulse curve is triangle.

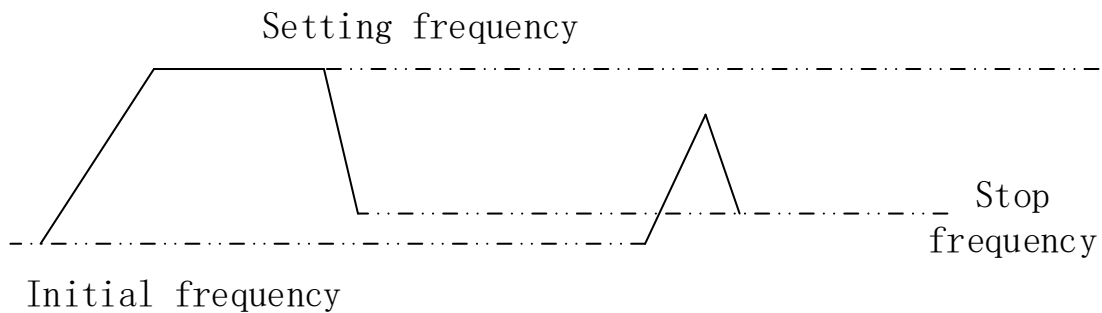

(4) One segment pulse outputting (not the last segment)

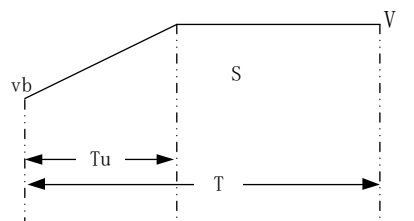

- V: setting present segment frequency
- S: present segment pulse numbers
- Vb: present segment initial frequency
- T: present segment pulse sending time
- Tu: pulse rising/falling time ( $Tu = (V-VB) / K$ , K is rising or falling slope).

(5) The last segment

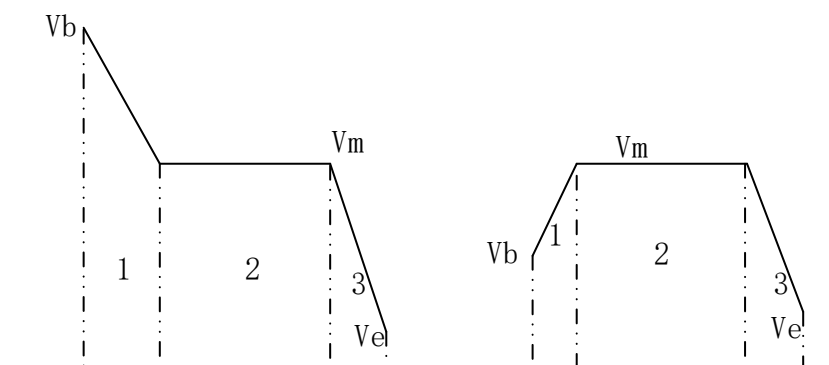

- The last segment includes rising/falling part, stable part, rising/falling part.

(6) the segment which the pulse numbers are 0

- If the present segment pulse frequency or pulse number is 0, it will output pulse as default speed.

(7) dynamic modify present pulse frequency

- Not the last segment

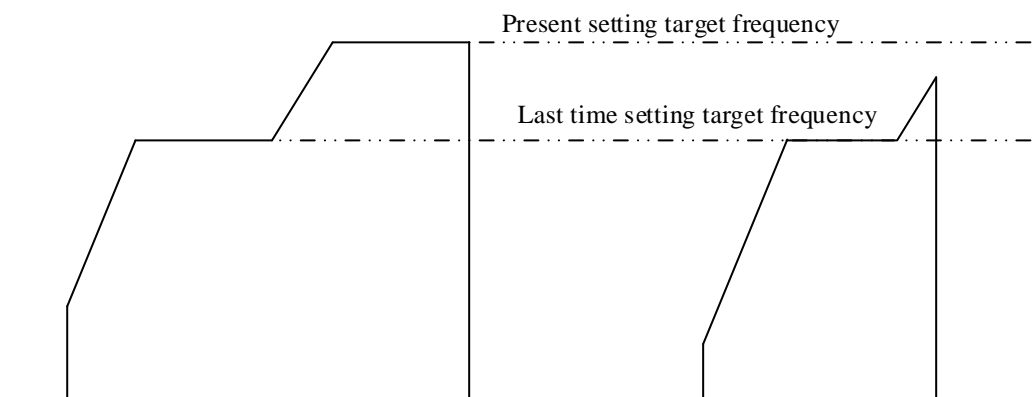
**Pulse numbers are enough****Pulse numbers are not enough**

When the present frequency is changed, it will accelerate/decelerate to target frequency as rising/falling slope.

- The last segment

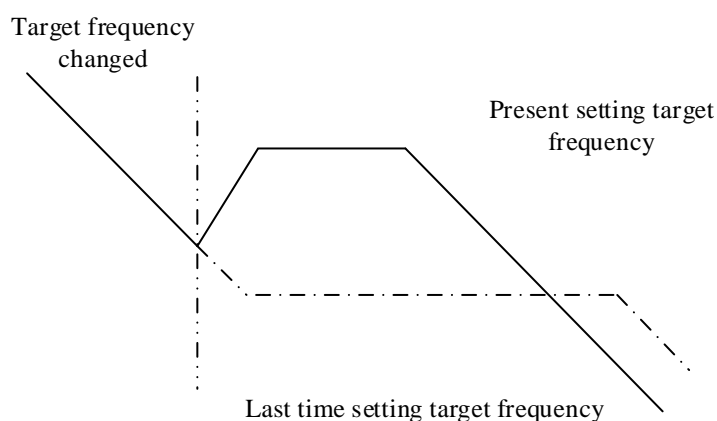

When the present pulse frequency is changed by user, PLC will calculate the pulse curve again, then output pulse as the new pulse curve.

**Example 1**

It needs to output 3 continuous segments of pulse, the pulse terminal is Y0, direction terminal is Y2.

Segment	Setting frequency (Hz)	Setting pulse numbers
Segment 1	1000	2000
Segment 2	200	1000
Segment 3	2000	6000
Acceleration/deceleration	The frequency will change 1000Hz every 100ms	



➤ Pulse curve

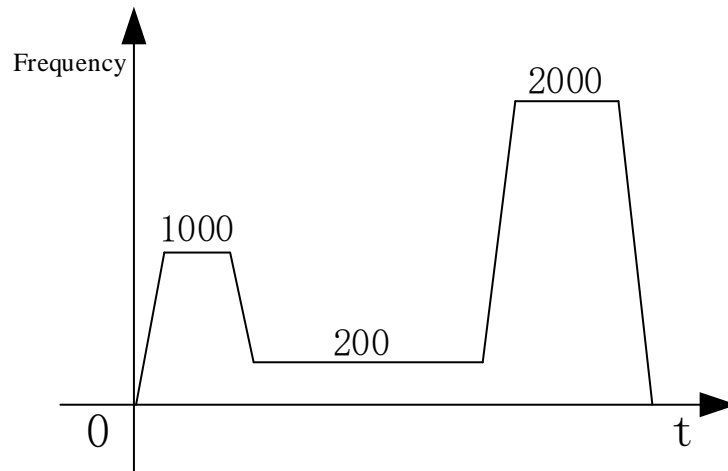

➤ Pulse instruction

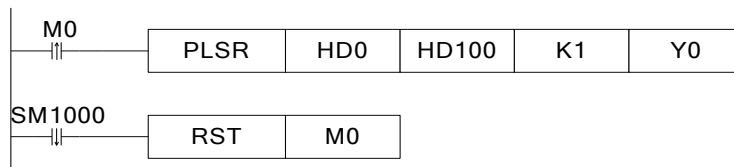

➤ Software configuration

(1) Pulse segment configuration

multi section pulse output ✖

data start address:	<input type="text" value="HD0"/>	user params address:	<input type="text" value="HD100"/>	system params:	<input type="text" value="K1"/>	output:	<input type="text" value="Y0"/>
mode:	<input type="text" value="relative"/>	start execute section count:	<input type="text" value="0"/>	<input type="button" value="Config"/>			

⋮ Add Delete | Upwards Downwards

	frequency	pulse count	wait condition	wait register	jump register
1	1000	2000	pulse sending complete	K0	K0
2	200	1000	pulse sending complete	K0	K0
▶ 3	2000	8000	pulse sending complete	K0	K0

used space: HD0-HD39,HD100-HD103

(2) Pulse configuration parameters

PLC1 - Pulse Set	
Config ▾ Delete   init axis   config guide	
Param	Value
Y0 axis-Common-Parameters setting-Pulse direction logic	positive logic
Y0 axis-Common-Parameters setting-enable soft limit	disable
Y0 axis-Common-Parameters setting-mechanical back to...	negative
Y0 axis-Common-Parameters setting-Pulse unit	pulse number
Y0 axis-Common-Parameters setting-Interpolation coord...	Cross coordi...
Y0 axis-Common-pulse send mode	complete
Y0 axis-Common-Pulse num (1)	1
Y0 axis-Common-Offset (1)	1
Y0 axis-Common-Pulse direction terminal	Y2
Y0 axis-Common-Delayed time of pulse direction (ms)	10

Param	Value
Y0 axis-Common-Gear clearance positive compensation	0
Y0 axis-Common-Gear clearance negative compensation	0
Y0 axis-Common-Electrical origin position	0
Y0 axis-Common-signal terminal switch state setting...	normally on
Y0 axis-Common-signal terminal switch state setting...	normally on
Y0 axis-Common-signal terminal switch state setting...	normally on
Y0 axis-Common-signal terminal switch state setting...	normally on
Y0 axis-Common-Far-point signal terminal setting	X no terminal
Y0 axis-Common-Z phase terminal setting	X no terminal
Y0 axis-Common-positive limit terminal setting	X no terminal
Y0 axis-Common-negative limit terminal setting	X no terminal

Param	Value
Y0 axis-Common-Zero clear CLR output setting	Y no terminal
Y0 axis-Common-Return speed VH	0
Y0 axis-Common-Creeping speed VC	0
Y0 axis-Common-Mechanical zero position	0
Y0 axis-Common-Z phase num	0
Y0 axis-Common-CLR signal delayed time (ms)	20
Y0 axis-Common-grinding wheel radius(polar)	0
Y0 axis-Common-soft limit positive value	0
Y0 axis-Common-soft limit negative value	0

Param	Value
Y0 axis-group 1-Pulse default speed	1000
Y0 axis-group 1-Acceleration time of Pulse default s...	100
Y0 axis-group 1-Deceleration time of pulse default s...	100
Y0 axis-group 1-Acceleration and deceleration time (ms)	0
Y0 axis-group 1-pulse acc/dec mode	linear acc/dec
Y0 axis-group 1-Max speed	200000
Y0 axis-group 1-Initial speed	0
Y0 axis-group 1-stop speed	0
Y0 axis-group 1-FOLLOW performance param(1-100)	50
Y0 axis-group 1-FOLLOW forward compensation(0-100)	0

(3) Pulse data address distribution table

Address	Notes	Value
HD0 (double word)	Pulse total segments (1 to 100)	3
HD2 (8 words)	Reserved	0
HD10 (double words)	Pulse frequency (#1)	1000
HD12 (double word)	Pulse number (#1)	2000
HD14	bit15~bit8: waiting condition (#1) H00: pulse sending completion H01: wait time H02: wait signal H03: ACT time H04: EXT signal H05: EXT signal or pulse sending completion bit7~bit0: waiting condition register type H00: constant H01: D H02: HD H03: FD H04: X H05: M H06: HM	0
HD15 (double word)	Constant value/ register no. (for waiting condition)(#1)	0
HD17	bit7~bit0: jump register type H00: constant value H01: D H02: HD	0

	H03: FD	
HD+18 (double word)	Constant value/register no. (for jump register)( #1)	0
HD+20 (double word)	Pulse frequency (#2)	200
HD+22 (double word)	Pulse number (#2)	1000
HD+24	Waiting condition, waiting condition register type (#2)	0
HD+25 (double word)	Constant value or register no. (for waiting condition) (#2)	0
HD+27	Jump type, jump register type (#2)	0
HD+28 (double word)	Constant value or register no. (for jump register) (#2)	0
HD+30 (double word)	Pulse frequency (#3)	2000
HD+32 (double word)	Pulse number (#3)	6000
HD+34	Waiting condition, waiting condition register type (#3)	0
HD+35 (double word)	Constant value or register no. (for waiting condition) (#3)	0
HD+37	Jump type, jump register type (for waiting condition) (#3)	0
HD+38 (double word)	Constant value or register no. (for jump register) (#3)	0

## (4) System parameters

SFD900	Pulse parameter setting	<p>Bit1: pulse direction logic 0: positive logic, 1: negative logic, default is 0</p> <p>Bit2: soft position limit 0: OFF 1: ON, default is 0</p> <p>Bit3: machine back to origin direction 0: negative direction 1: positive direction, default is 0</p> <p>Bit10~ Bit8: pulse unit Bit8: 0: pulse numbers, 1: equivalent 000: pulse numbers 001: micron 011: centimillimeter 101: decimillimeter 111: millimeter Default is 000</p> <p>Bit13: pulse type 0: single direction pulse 1: AB phase pulse (only for XD5-48D4T4-E), default is 0</p> <p>Bit15: interpolation coordinate mode 0: cross coordinate, 1: polar coordinate, default is 0</p>	0	Common parameter
SFD901	Pulse sending mode	<p>Bit 0: pulse sending mode 0: complete mode 1: subsequence mode, default is 0</p>	0	
SFD902	Pulse number/1 rotation low 16 bits		1	
SFD903	Pulse number/1 rotation high 16 bits		0	
SFD904	Motion quantity/1 rotation low 16 bits		1	
SFD905	Motion quantity/1 rotation high 16 bits		0	
SFD906	Pulse direction terminal	Y terminal no., 0xFF is no terminal	2	
SFD907	Direction delay time	Default is 20, unit: ms	20	
SFD908	Gear clearance positive compensation		0	
SFD909	Gear clearance negative compensation		0	
SFD910	Electrical origin low 16 bits		0	
SFD911	Electrical origin high 16 bits		0	

SFD912	Signal terminal state setting	Bit0: origin signal switch state Bit1: Z phase switch state Bit2: positive limit switch state Bit3: negative limit switch state 0: normally open(positive logic) 1: normally close(negative logic) default is 0	0	Group 1
SFD914	Z phase terminal setting	Bit0~bit7: set X terminal, 0xFF is no terminal(interruption)	0xFF	
SFD915	Limit terminal setting	Bit7~bit0: X terminal of positive limit, 0xFF is no terminal Bit15~bit8: X terminal of negative limit, 0xFF is no terminal	FFFF	
SFD917	Clear signal CLR output terminal	Bit0~Bit7: Y terminal, 0xFF is no terminal	0xFF	
SFD918	Returning speed VH low 16 bits		0	
SFD919	Returning speed VH high 16 bits		0	
SFD922	Crawling speed VC low 16 bits		0	
SFD923	Crawling speed VC high 16 bits		0	
SFD924	Mechanical origin position low 16 bits		0	
SFD925	Mechanical origin position high 16 bits		0	
SFD926	Z phase numbers		0	
SFD927	CLR signal delay time	Default 20, unit: ms	20	
SFD928	Grinding wheel radius(polar coordinate)	Low 16 bits	0	
SFD929		High 16 bits	0	
SFD930	Soft limit positive limit value	Low 16 bits	0	
SFD931		High 16 bits	0	
SFD932	Soft limit negative limit value	Low 16 bits	0	
SFD933		High 16 bits	0	
...				
SFD950	Pulse default speed low 16 bits	It will send pulse with default speed when the speed is 0.	1000	
SFD951	Pulse default speed high 16 bits		0	
SFD952	Pulse default speed acceleration time		100	

SFD953	Pulse default speed deceleration time		100
SFD954	Acceleration and deceleration time		0
SFD955	Pulse acceleration and deceleration mode	Bit 1~0: acc/dec mode 00: line 01: S curve 10: sine curve 11: reserved Bit 15~2: reserved	
SFD956	Max speed limit low 16 bits		3392
SFD957	Max speed limit high 16 bits		3
SFD958	Initial speed low 16 bits		0
SFD959	Initial speed high 16 bits		0
SFD960	Stop speed low 16 bits		0
SFD961	Stop speed high 16 bits		0
SFD962	Follow performance parameters	1~100, 100 means the time constant is one tick, 1 means the time constant is 100 tick.	50
SFD963	Follow feedforward compensation	0~100, percentage	0
...			

**Note:**

- ※1: As there are many configuration parameters of PLSR, we suggest to use software configuration table to set the parameters.
- ※2: if user needs to set each segment pulse frequency and pulse numbers in the HMI, please configure through the configuration table first, then use instruction DMOV in the program to set the registers (S0+N\*10+0, S0+N\*10+2).

For example:

```

DMOV HD200 HD10 //HD200 set segment 1 pulse frequency in HMI
DMOV HD202 HD12 //HD202 set segment 1 pulse numbers in HMI
DMOV HD204 HD20 //HD204 set segment 2 pulse frequency in HMI
DMOV HD206 HD22 //HD206 set segment 2 pulse numbers in HMI
DMOV HD208 HD30 //HD208 set segment 3 pulse frequency in HMI
DMOV HD210 HD32 //HD210 set segment 3 pulse numbers in HMI

```

It can also set pulse frequency and numbers in registers HD10, HD12, HD20, HD22, HD30, HD32 directly in the HMI.

**Example 2**

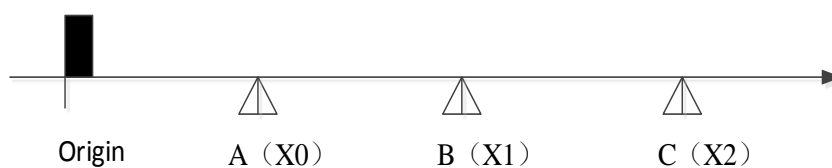

As the above diagram, it needs to move three segments of distance, the position of A, B, C is unknown and the moving speed is different for each segment. We can configure the PLSR to do it. First we install proximity switch at point A, B, C and connect to PLC input X0, X1, X2. The pulse output terminal is Y0, the direction terminal is Y2.

Each segment pulse frequency and numbers:

Segment	Frequency setting (Hz)	Pulse number setting
Origin to A	1000	999999999
A to B	3000	999999999
B to C	2000	999999999
Acceleration/deceleration time	The frequency will change 1000Hz every 100ms	

Note:

As the pulse numbers are unknown for each segment, we set a very large pulse numbers to ensure it can reach the proximity switch. When it reaches point C, the pulse will urgent stop by instruction STOP.

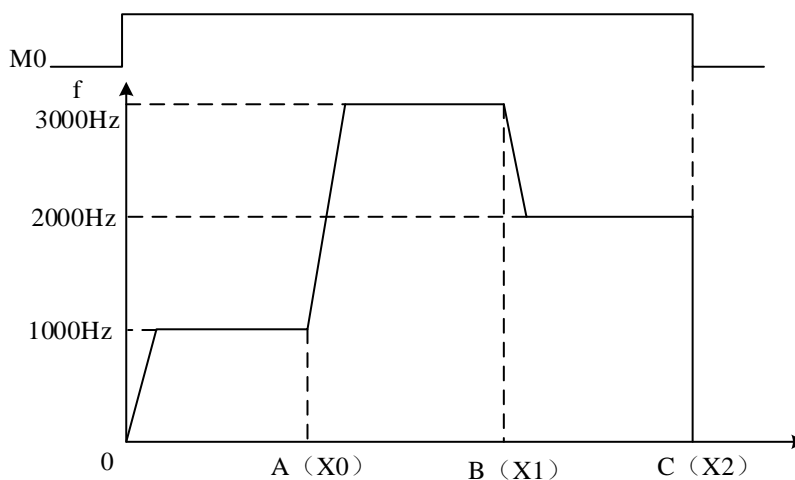

➤ Pulse instructions

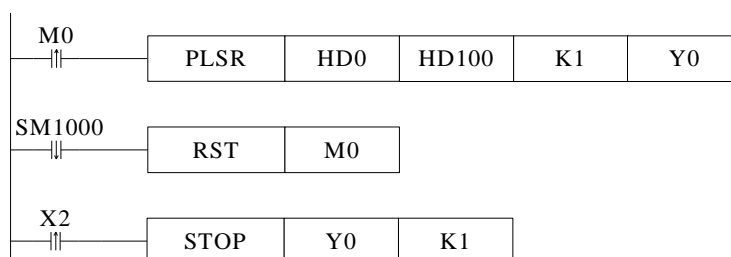



➤ Software configuration

(1) Pulse segment configuration

multi section pulse output

data start address: HD0 user params address: HD100 system params: K1 output: Y0

mode: relative start execute section count: 0 Config

Add Delete Upwards Downwards

	frequency	pulse count	wait condition	wait register	jump register
1	1000	999999999	EXT signal	X0	K0
2	2000	999999999	EXT signal	X1	K0
▶ 3	2000	999999999	EXT signal	X2	K0

used space: HD0-HD39,HD100-HD103

Read From PLC Write To PLC OK Cancel

(2) Pulse configuration parameters

Param	Value
Y0 axis-Common-Parameters setting-Pulse direction logic	positive logic
Y0 axis-Common-Parameters setting-enable soft limit	disable
Y0 axis-Common-Parameters setting-mechanical back to th...	negative
Y0 axis-Common-Parameters setting-Pulse unit	pulse number
Y0 axis-Common-Parameters setting-Interpolation coordin...	Cross coordin...
Y0 axis-Common-pulse send mode	complete
Y0 axis-Common-Pulse num (1)	1
Y0 axis-Common-Offset (1)	1
Y0 axis-Common-Pulse direction terminal	Y2
Y0 axis-Common-Delayed time of pulse direction (ms)	10

Param	Value
Y0 axis-Common-Gear clearance positive compensation	0
Y0 axis-Common-Gear clearance negative compensation	0
Y0 axis-Common-Electrical origin position	0
Y0 axis-Common-signal terminal switch state setting-Far...	normally on
Y0 axis-Common-signal terminal switch state setting-Z p...	normally on
Y0 axis-Common-signal terminal switch state setting-pos...	normally on
Y0 axis-Common-signal terminal switch state setting-neg...	normally on
Y0 axis-Common-Far-point signal terminal setting	X no terminal
Y0 axis-Common-Z phase terminal setting	X no terminal
Y0 axis-Common-positive limit terminal setting	X no terminal

Param	Value
Y0 axis-Common-negative limit terminal setting	X no terminal
Y0 axis-Common-Zero clear CLR output setting	Y no terminal
Y0 axis-Common-Return speed VH	0
Y0 axis-Common-Creeping speed VC	0
Y0 axis-Common-Mechanical zero position	0
Y0 axis-Common-Z phase num	0
Y0 axis-Common-CLR signal delayed time (ms)	20
Y0 axis-Common-grinding wheel radius(polar)	0
Y0 axis-Common-soft limit positive value	0
Y0 axis-Common-soft limit negative value	0

Param	Value
Y0 axis-group 1-Pulse default speed	1000
Y0 axis-group 1-Acceleration time of Pulse default spee...	100
Y0 axis-group 1-Deceleration time of pulse default spee...	100
Y0 axis-group 1-Acceleration and deceleration time (ms)	0
Y0 axis-group 1-pulse acc/dec mode	linear acc/dec
Y0 axis-group 1-Max speed	200000
Y0 axis-group 1-Initial speed	0
Y0 axis-group 1-stop speed	0
Y0 axis-group 1-FOLLOW performance param(1-100)	50
Y0 axis-group 1-FOLLOW forward compensation(0-100)	0

(3) Pulse data address distribution table

Address	Notes	Value
HD0 (double word)	Pulse total segments (1 to 100)	3
HD2 (8 words)	Reserved	0
HD10 (double words)	Pulse frequency (#1)	1000
HD12 (double word)	Pulse number (#1)	99999999
HD14	bit15~bit8: waiting condition (#1) H00: pulse sending completion H01: wait time H02: wait signal H03: ACT time H04: EXT signal H05: EXT signal or pulse sending completion	1028

	bit7~bit0: waiting condition register type H00: constant H01: D H02: HD H03: FD H04: X H05: M H06: HM	
HD15 (double word)	Constant value/ register no. (for waiting condition)(#1)	0
HD17	bit7~bit0: jump register type H00: constant value H01: D H02: HD H03: FD	0
HD+18 (double word)	Constant value/register no. (for jump register)( #1)	0
HD+20 (double word)	Pulse frequency (#2)	3000
HD+22 (double word)	Pulse number (#2)	999999999
HD+24	Waiting condition, waiting condition register type (#2)	1028
HD+25 (double word)	Constant value or register no. (for waiting condition) (#2)	1
HD+27	Jump type, jump register type (#2)	0
HD+28 (double word)	Constant value or register no. (for jump register) (#2)	0
HD+30 (double word)	Pulse frequency (#3)	2000
HD+32 (double word)	Pulse number (#3)	999999999
HD+34	Waiting condition, waiting condition register type (#3)	1028
HD+35 (double word)	Constant value or register no. (for waiting condition) (#3)	2
HD+37	Jump type, jump register type (for waiting condition) (#3)	0
HD+38 (double word)	Constant value or register no. (for jump register) (#3)	0

## (4) System parameters

SFD900	Pulse parameter setting	<p>Bit1: pulse direction logic 0: positive logic, 1: negative logic, default is 0</p> <p>Bit2: soft position limit 0: OFF 1: ON, default is 0</p> <p>Bit3: machine back to origin direction 0: negative direction 1: positive direction, default is 0</p> <p>Bit10~ Bit8: pulse unit Bit8: 0: pulse numbers, 1: equivalent 000: pulse numbers 001: micron 011: centimillimeter 101: decimillimeter 111: millimeter Default is 000</p> <p>Bit13: pulse type 0: single direction pulse 1: AB phase pulse (only for XD5-48D4T4-E), default is 0</p> <p>Bit15: interpolation coordinate mode 0: cross coordinate, 1: polar coordinate, default is 0</p>	0	Common parameter
SFD901	Pulse sending mode	<p>Bit 0: pulse sending mode 0: complete mode 1: subsequence mode, default is 0</p>	1	
SFD902	Pulse number/1 rotation low 16 bits		0	
SFD903	Pulse number/1 rotation high 16 bits		1	
SFD904	Motion quantity/1 rotation low 16 bits		0	
SFD905	Motion quantity/1 rotation high 16 bits		2	
SFD906	Pulse direction terminal	Y terminal no., 0xFF is no terminal	20	
SFD907	Direction delay time	Default is 20, unit: ms	0	
SFD908	Gear clearance positive compensation		0	
SFD909	Gear clearance negative compensation		0	
SFD910	Electrical origin low 16 bits		0	
SFD911	Electrical origin high 16 bits		0	

SFD912	Signal terminal state setting	Bit0: origin signal switch state Bit1: Z phase switch state Bit2: positive limit switch state Bit3: negative limit switch state 0: normally open(positive logic) 1: normally close(negative logic) default is 0	0xFF	Group 1
SFD914	Z phase terminal setting	Bit0~bit7: set X terminal, 0xFF is no terminal(interruption)	FFFF	
SFD915	Limit terminal setting	Bit7~bit0: X terminal of positive limit, 0xFF is no terminal Bit15~bit8: X terminal of negative limit, 0xFF is no terminal	0xFF	
SFD917	Clear signal CLR output terminal	Bit0~Bit7: Y terminal, 0xFF is no terminal	0	
SFD918	Returning speed VH low 16 bits		0	
SFD919	Returning speed VH high 16 bits		0	
SFD922	Crawling speed VC low 16 bits		0	
SFD923	Crawling speed VC high 16 bits		0	
SFD924	Mechanical origin position low 16 bits		0	
SFD925	Mechanical origin position high 16 bits		0	
SFD926	Z phase numbers		20	
SFD927	CLR signal delay time	Default 20, unit: ms	0	
SFD928	Grinding wheel radius(polar coordinate)	Low 16 bits	0	
SFD929		High 16 bits	0	
SFD930	Soft limit positive limit value	Low 16 bits	0	
SFD931		High 16 bits	0	
SFD932	Soft limit negative limit value	Low 16 bits	0	
SFD933		High 16 bits	1	
...				
SFD950	Pulse default speed low 16 bits	It will send pulse with default speed when the speed is 0.	1000	
SFD951	Pulse default speed high 16 bits		0	
SFD952	Pulse default speed acceleration time		100	

SFD953	Pulse default speed deceleration time		100
SFD954	Acceleration and deceleration time		0
SFD955	Pulse acceleration and deceleration mode	Bit 1~0: acc/dec mode 00: line 01: S curve 10: sine curve 11: reserved Bit 15~2: reserved	0
SFD956	Max speed limit low 16 bits		3392
SFD957	Max speed limit high 16 bits		3
SFD958	Initial speed low 16 bits		0
SFD959	Initial speed high 16 bits		0
SFD960	Stop speed low 16 bits		0
SFD961	Stop speed high 16 bits		0
SFD962	Follow performance parameters	1~100, 100 means the time constant is one tick, 1 means the time constant is 100 tick.	50
SFD963	Follow feedforward compensation	0~100, percentage	0
...			

**Note:**

- ※1: As there are many configuration parameters of PLSR, we suggest to use software configuration table to set the parameters.
- ※2: if user needs to set each segment pulse frequency and pulse numbers in the HMI, please configure through the configuration table first, then use instruction DMOV in the program to set the registers (S0+N\*10+0, S0+N\*10+2).

For example:

```

DMOV HD200 HD10 //HD200 set segment 1 pulse frequency in HMI
DMOV HD202 HD12 //HD202 set segment 1 pulse numbers in HMI
DMOV HD204 HD20 //HD204 set segment 2 pulse frequency in HMI
DMOV HD206 HD22 //HD206 set segment 2 pulse numbers in HMI
DMOV HD208 HD30 //HD208 set segment 3 pulse frequency in HMI
DMOV HD210 HD32 //HD210 set segment 3 pulse numbers in HMI

```

It can also set pulse frequency and numbers in registers HD10, HD12, HD20, HD22, HD30, HD32 directly in the HMI.

### Example 3

It needs to execute 4 segments of pulse: segment 1 pulse frequency is 2000Hz, pulse number is 3000, it will delay 100ms then segment 2 is executed. Segment 2 pulse frequency is 2800Hz, pulse number is 4000. It will wait for M100, when M100 is ON, the segment 3 starts to run. Segment 3 pulse frequency is 1200Hz, pulse number is 99999999. It will delay ACT time 2s after the pulse is outputting then switch to segment 4 at once. Segment 4 pulse frequency is 3000Hz, pulse number is 99999999. When the external signal X2 is ON, it will decelerate and stop the pulse. Pulse acceleration slope is 80ms every 1000Hz, deceleration slope is 120ms every 1000Hz. The pulse direction terminal is Y2.

#### ➤ Pulse curve:

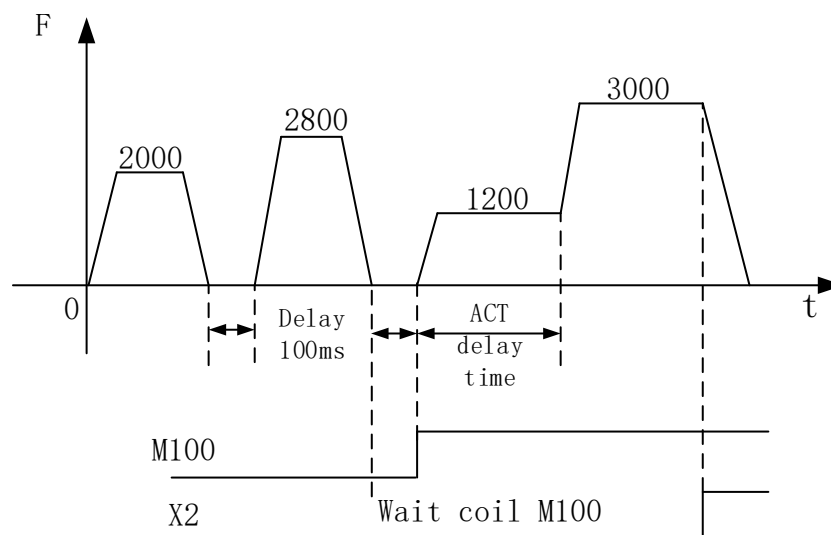

#### ➤ Pulse instruction

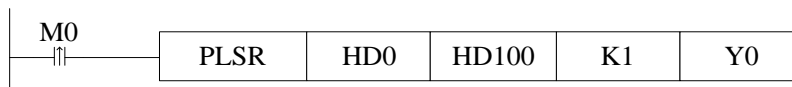

#### ➤ Pulse data configuration

##### (1) Pulse segment configuration

multi section pulse output

data start address: HD0 user params address: HD100 system params: K1 output: Y0

mode: relative start execute section count: 0 Config

Add Delete Upwards Downwards

	frequency	pulse count	wait condition	wait register	jump register
▶ 1	2000	3000	wait time	K100	K0
2	2800	4000	wait signal	M100	K0
3	1200	999999999	ACT time	K2000	K0
4	3000	999999999	EXT signal	X2	K0

used space: HD0-HD49,HD100-HD103 Read From PLC Write To PLC OK Cancel

Pulse data configuration (relative mode)

multi section pulse output

data start address: HD0 user params address: HD100 system params: K1 output: Y0

mode: absolut start execute section count: 0 Config

Add Delete Upwards Downwards

	frequency	pulse count	wait condition	wait register	jump register
1	2000	3000	wait time	K100	K0
2	2800	7000	wait signal	M100	K0
3	1200	1000006999	ACT time	K2000	K0
▶ 4	3000	2000006998	EXT signal	X2	K0

used space: HD0-HD49,HD100-HD103 Read From PLC Write To PLC OK Cancel

Pulse data configuration (absolute mode)

## (2) System parameters

Param	Value
Y0 axis-Common-Parameters setting-Pulse direction logic	positive logic
Y0 axis-Common-Parameters setting-enable soft limit	disable
Y0 axis-Common-Parameters setting-mechanical back to...	negative
Y0 axis-Common-Parameters setting-Pulse unit	pulse number
Y0 axis-Common-Parameters setting-Interpolation coor...	Cross coordi...
Y0 axis-Common-pulse send mode	complete
Y0 axis-Common-Pulse num (1)	1
Y0 axis-Common-Offset (1)	1
Y0 axis-Common-Pulse direction terminal	Y2
Y0 axis-Common-Delayed time of pulse direction (ms)	10



Param	Value
Y0 axis-Common-Gear clearance positive compensation	0
Y0 axis-Common-Gear clearance negative compensation	0
Y0 axis-Common-Electrical origin position	0
Y0 axis-Common-signal terminal switch state setting...	normally on
Y0 axis-Common-signal terminal switch state setting...	normally on
Y0 axis-Common-signal terminal switch state setting...	normally on
Y0 axis-Common-signal terminal switch state setting...	normally on
Y0 axis-Common-Far-point signal terminal setting	X no terminal
Y0 axis-Common-Z phase terminal setting	X no terminal
Y0 axis-Common-positive limit terminal setting	X no terminal

Param	Value
Y0 axis-Common-negative limit terminal setting	X no terminal
Y0 axis-Common-Zero clear CLR output setting	Y no terminal
Y0 axis-Common-Return speed VH	0
Y0 axis-Common-Creeping speed VC	0
Y0 axis-Common-Mechanical zero position	0
Y0 axis-Common-Z phase num	0
Y0 axis-Common-CLR signal delayed time (ms)	20
Y0 axis-Common-grinding wheel radius(polar)	0
Y0 axis-Common-soft limit positive value	0
Y0 axis-Common-soft limit negative value	0

Param	Value
Y0 axis-group 1-Pulse default speed	1000
Y0 axis-group 1-Acceleration time of Pulse default s...	80
Y0 axis-group 1-Deceleration time of pulse default s...	120
Y0 axis-group 1-Acceleration and deceleration time (ms)	0
Y0 axis-group 1-pulse acc/dec mode	linear acc/dec
Y0 axis-group 1-Max speed	200000
Y0 axis-group 1-Initial speed	0
Y0 axis-group 1-stop speed	0
Y0 axis-group 1-FOLLOW performance param(1-100)	50
Y0 axis-group 1-FOLLOW forward compensation(0-100)	0

(3) Pulse data address distribution table

Address	Notes	Value
HD0 (double word)	Pulse total segments (1 to 100)	4

HD2 (8 words)	Reserved	0
HD10 (double words)	Pulse frequency (#1)	2000
HD12 (double word)	Pulse number (#1)	3000
HD14	bit15~bit8: waiting condition (#1) H00: pulse sending completion H01: wait time H02: wait signal H03: ACT time H04: EXT signal H05: EXT signal or pulse sending completion bit7~bit0: waiting condition register type H00: constant H01: D H02: HD H03: FD H04: X H05: M H06: HM	256
HD15 (double word)	Constant value/ register no. (for waiting condition)(#1)	100
HD17	bit7~bit0: jump register type H00: constant value H01: D H02: HD H03: FD	0
HD+18 (double word)	Constant value/register no. (for jump register)( #1)	0
HD+20 (double word)	Pulse frequency (#2)	2800
HD+22 (double word)	Pulse number (#2)	7000
HD+24	Waiting condition, waiting condition register type (#2)	517
HD+25 (double word)	Constant value or register no. (for waiting condition) (#2)	100
HD+27	Jump type, jump register type (#2)	0
HD+28 (double word)	Constant value or register no. (for jump register) (#2)	0
HD+30 (double word)	Pulse frequency (#3)	1200
HD+32 (double word)	Pulse number (#3)	999999999

HD+34	Waiting condition, waiting condition register type (#3)	768
HD+35 (double word)	Constant value or register no. (for waiting condition) (#3)	2000
HD+37	Jump type, jump register type (for waiting condition) (#3)	0
HD+38 (double word)	Constant value or register no. (for jump register) (#3)	0
HD+40 (double word)	Pulse frequency (#4)	3000
HD+42 (double word)	Pulse number (#4)	999999999
HD+44	Waiting condition, waiting condition register type (#4)	1028
HD+45 (double word)	Constant value or register no. (for waiting condition) (#4)	2
HD+47	Jump type, jump register type (for waiting condition) (#4)	0
HD+48 (double word)	Constant value or register no. (for jump register) (#4)	0

## (4) System parameters

SFD900	Pulse parameter setting	<p>Bit1: pulse direction logic 0: positive logic, 1: negative logic, default is 0</p> <p>Bit2: soft position limit 0: OFF 1: ON, default is 0</p> <p>Bit3: machine back to origin direction 0: negative direction 1: positive direction, default is 0</p> <p>Bit10~ Bit8: pulse unit Bit8: 0: pulse numbers, 1: equivalent 000: pulse numbers 001: micron 011: centimillimeter 101: decimillimeter 111: millimeter Default is 000</p> <p>Bit13: pulse type 0: single direction pulse 1: AB phase pulse (only for XD5-48D4T4-E), default is 0</p> <p>Bit15: interpolation coordinate mode 0: cross coordinate, 1: polar coordinate, default is 0</p>	0	Common parameter
--------	-------------------------	---	---	------------------

SFD901	Pulse sending mode	Bit 0: pulse sending mode 0: complete mode 1: subsequence mode, default is 0	0
SFD902	Pulse number/1 rotation low 16 bits		1
SFD903	Pulse number/1 rotation high 16 bits		0
SFD904	Motion quantity/1 rotation low 16 bits		1
SFD905	Motion quantity/1 rotation high 16 bits		0
SFD906	Pulse direction terminal	Y terminal no., 0xFF is no terminal	2
SFD907	Direction delay time	Default is 20, unit: ms	20
SFD908	Gear clearance positive compensation		0
SFD909	Gear clearance negative compensation		0
SFD910	Electrical origin low 16 bits		0
SFD911	Electrical origin high 16 bits		0
SFD912	Signal terminal state setting	Bit0: origin signal switch state Bit1: Z phase switch state Bit2: positive limit switch state Bit3: negative limit switch state 0: normally open(positive logic) 1: normally close(negative logic) default is 0	0
SFD914	Z phase terminal setting	Bit0~bit7: set X terminal, 0xFF is no terminal(interruption)	0xFF
SFD915	Limit terminal setting	Bit7~bit0: X terminal of positive limit, 0xFF is no terminal Bit15~bit8: X terminal of negative limit, 0xFF is no terminal	FFFF
SFD917	Clear signal CLR output terminal	Bit0~Bit7: Y terminal, 0xFF is no terminal	0xFF
SFD918	Returning speed VH low 16 bits		0
SFD919	Returning speed VH high 16 bits		0
SFD922	Crawling speed VC low 16 bits		0
SFD923	Crawling speed VC high 16 bits		0

SFD924	Mechanical origin position low 16 bits		0	
SFD925	Mechanical origin position high 16 bits		0	
SFD926	Z phase numbers		0	
SFD927	CLR signal delay time	Default 20, unit: ms	20	
SFD928	Grinding wheel radius(polar coordinate)	Low 16 bits	0	
SFD929		High 16 bits	0	
SFD930	Soft limit positive limit value	Low 16 bits	0	
SFD931		High 16 bits	0	
SFD932	Soft limit negative limit value	Low 16 bits	0	
SFD933		High 16 bits	0	
...				
SFD950	Pulse default speed low 16 bits	It will send pulse with default speed when the speed is 0.	1000	
SFD951	Pulse default speed high 16 bits		0	
SFD952	Pulse default speed acceleration time		100	
SFD953	Pulse default speed deceleration time		100	
SFD954	Acceleration and deceleration time		0	
SFD955	Pulse acceleration and deceleration mode	Bit 1~0: acc/dec mode 00: line 01: S curve 10: sine curve 11: reserved Bit 15~2: reserved	0	
SFD956	Max speed limit low 16 bits		3392	
SFD957	Max speed limit high 16 bits		3	
SFD958	Initial speed low 16 bits		0	
SFD959	Initial speed high 16 bits		0	
SFD960	Stop speed low 16 bits		0	
SFD961	Stop speed high 16 bits		0	
SFD962	Follow performance parameters	1~100, 100 means the time constant is one tick, 1 means the time constant is 100 tick.	50	
SFD963	Follow feedforward compensation	0~100, percentage	0	
...				

**Note:**

- ※1: As there are many configuration parameters of PLSR, we suggest to use software configuration table to set the parameters.
- ※2: if user needs to set each segment pulse frequency and pulse numbers in the HMI, please configure through the configuration table first, then use instruction DMOV in the program to set the registers (S0+N\*10+0, S0+N\*10+2).

For example:

```

DMOV  HD200  HD10      //HD200 set segment 1 pulse frequency in HMI
DMOV  HD202  HD12      //HD202 set segment 1 pulse numbers in HMI
DMOV  HD204  HD20      //HD204 set segment 2 pulse frequency in HMI
DMOV  HD206  HD22      //HD206 set segment 2 pulse numbers in HMI
DMOV  HD208  HD30      //HD208 set segment 3 pulse frequency in HMI
DMOV  HD210  HD32      //HD210 set segment 3 pulse numbers in HMI
DMOV  HD212  HD40      //HD212 set segment 4 pulse frequency in HMI
DMOV  HD214  HD42      //HD214 set segment 4 pulse numbers in HMI

```

It can also set pulse frequency and numbers in registers HD10, HD12, HD20, HD22, HD30, HD32, HD40, HD42 directly in the HMI.

#### Example 4

There is a transmission mechanism which includes one servo drive (electronic gear ratio is 1:1), one servo motor (encoder is 2500ppr), it connects the ball screw through a reducer (the reduction ratio is 1:2), the ball screw pitch is 10mm, the ball screw drives a working table which can move left and right. Now it needs to move the table from left to right for 200mm, then move in reverse direction for 200mm, the speed is 20mm/s, acceleration time is 100ms, deceleration time is 200ms, the pulse direction terminal is Y2.

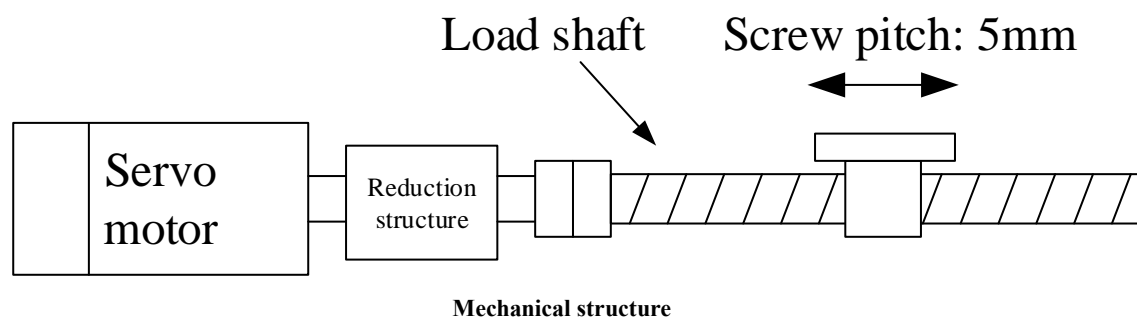

$$\text{Pulse number per rotate} = 20000 = 2500 * 4 * \frac{2}{1}$$

Motion quantity per rotate= pitch = 10mm

$$20\text{mm/s} = \frac{20\text{mm}}{10\text{mm}} * 20000 = 40000 \text{ pulse/s}$$

The max pulse output frequency is 40K/s, less than 200K/s, the PLC can run well.

➤ Pulse curve

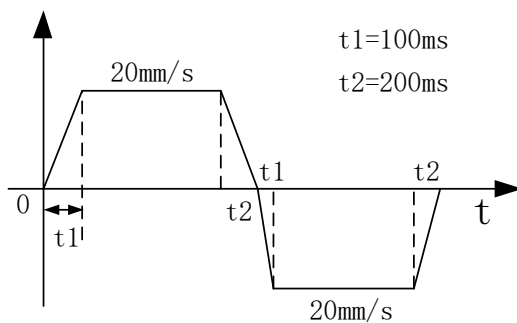

➤ Pulse instruction

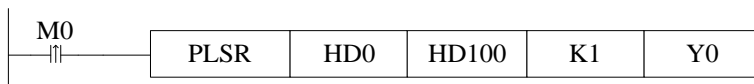

➤ Pulse configuration

(1) Pulse segment configuration

multi section pulse output ✖

data start address:	HD0	user params address:	HD100	system params:	K1	output:	Y0
mode:	relative	start execute section count:	0	Config			

Add Delete Upwards Downwards

	frequence	pulse count	wait condition	wait register	jump register
1	20	200	pulse sending complete	K0	K0
▶ 2	20	-200	pulse sending complete	K0	K0

used space: HD0-HD29,HD100-HD103

Read From PLC Write To PLC OK Cancel

Relative mode

multi section pulse output ✕

data start address:	<input type="text" value="HD0"/>	user params address:	<input type="text" value="HD100"/>	system params:	<input type="text" value="K1"/>	output:	<input type="text" value="Y0"/>
mode:	<input type="text" value="absolut"/> ▾	start execute section count:	<input type="text" value="0"/>	<input type="button" value="Config"/>			

⋮ Add Delete | Upwards Downwards

	frequency	pulse count	wait condition	wait register	jump register
1	20	200	pulse sending complete	K0	K0
▶ 2	20	0	pulse sending complete	K0	K0

used space: HD0-HD29,HD100-HD103

### Absolute mode

#### (2) System parameters (relative mode)

Param	Value
Y0 axis-Common-Parameters setting-Pulse direction logic	positive logic
Y0 axis-Common-Parameters setting-enable soft limit	disable
Y0 axis-Common-Parameters setting-mechanical back to...	negative
Y0 axis-Common-Parameters setting-Pulse unit	1mm
Y0 axis-Common-Parameters setting-Interpolation coordin...	Cross coordin...
Y0 axis-Common-pulse send mode	complete
Y0 axis-Common-Pulse num (1)	20000
Y0 axis-Common-1mm(revolve)	10
Y0 axis-Common-Pulse direction terminal	Y2
Y0 axis-Common-Delayed time of pulse direction (ms)	10

Param	Value
Y0 axis-Common-Gear clearance positive compensation	0
Y0 axis-Common-Gear clearance negative compensation	0
Y0 axis-Common-Electrical origin position	0
Y0 axis-Common-signal terminal switch state setting...	normally on
Y0 axis-Common-signal terminal switch state setting...	normally on
Y0 axis-Common-signal terminal switch state setting...	normally on
Y0 axis-Common-signal terminal switch state setting...	normally on
Y0 axis-Common-Far-point signal terminal setting	X no terminal
Y0 axis-Common-Z phase terminal setting	X no terminal
Y0 axis-Common-positive limit terminal setting	X no terminal



Param	Value
Y0 axis-Common-negative limit terminal setting	X no terminal
Y0 axis-Common-Zero clear CLR output setting	Y no terminal
Y0 axis-Common-Return speed VH	0
Y0 axis-Common-Creeping speed VC	0
Y0 axis-Common-Mechanical zero position	0
Y0 axis-Common-Z phase num	0
Y0 axis-Common-CLR signal delayed time (ms)	20
Y0 axis-Common-grinding wheel radius(polar)	0
Y0 axis-Common-soft limit positive value	0
Y0 axis-Common-soft limit negative value	0

Param	Value
Y0 axis-group 1-Pulse default speed	20
Y0 axis-group 1-Acceleration time of Pulse default s...	100
Y0 axis-group 1-Deceleration time of pulse default s...	200
Y0 axis-group 1-Acceleration and deceleration time (ms)	0
Y0 axis-group 1-pulse acc/dec mode	linear acc/dec
Y0 axis-group 1-Max speed	100
Y0 axis-group 1-Initial speed	0
Y0 axis-group 1-stop speed	0
Y0 axis-group 1-FOLLOW performance param(1-100)	50
Y0 axis-group 1-FOLLOW forward compensation(0-100)	0

(3) Pulse data address distribution table

Address	Notes	Value
HD0 (double word)	Pulse total segments (1 to 100)	2
HD2 (8 words)	Reserved	0
HD10 (double words)	Pulse frequency (#1)	20
HD12 (double word)	Pulse number (#1)	200
HD14	bit15~bit8: waiting condition (#1) H00: pulse sending completion H01: wait time H02: wait signal H03: ACT time H04: EXT signal H05: EXT signal or pulse sending completion bit7~bit0: waiting condition register type	0

	H00: constant H01: D H02: HD H03: FD H04: X H05: M H06: HM	
HD15 (double word)	Constant value/ register no. (for waiting condition)(#1)	0
HD17	bit7~bit0: jump register type H00: constant value H01: D H02: HD H03: FD	0
HD+18 (double word)	Constant value/register no. (for jump register)( #1)	0
HD+20 (double word)	Pulse frequency (#2)	20
HD+22 (double word)	Pulse number (#2)	-200
HD+24	Waiting condition, waiting condition register type (#2)	0
HD+25 (double word)	Constant value or register no. (for waiting condition) (#2)	0
HD+27	Jump type, jump register type (#2)	0
HD+28 (double word)	Constant value or register no. (for jump register) (#2)	0

## (4) System parameters

SFD900	Pulse parameter setting	<p>Bit 1: pulse direction logic 0: positive logic 1: negative logic, default is 0</p> <p>Bit 2: use soft limit function 0: not use 1: use default is 0</p> <p>Bit 3: mechanical return to origin direction 0: negative direction 1: positive direction default is 0</p> <p>Bit 10~8: pulse unit Bit8: 0: pulse number 1: equivalent 000: pulse number 001: 1 um 011: 0.01mm 101: 0.1mm 111: 1 mm Default is 000</p> <p>Bit15: interpolation coordinate mode 0: cross coordinate 1: polar coordinate Default is 0</p>	1792	Common parameter
SFD901	Pulse sending mode	<p>Bit 0: pulse sending mode 0: complete mode 1: subsequence mode, default is 0</p>	0	
SFD902	Pulse number/1 rotation low 16 bits		20000	
SFD903	Pulse number/1 rotation high 16 bits			
SFD904	Motion quantity/1 rotation low 16 bits		10	
SFD905	Motion quantity/1 rotation high 16 bits			
SFD906	Pulse direction terminal	Y terminal no., 0xFF is no terminal	2	
SFD907	Direction delay time	Default is 20, unit: ms	20	
SFD908	Gear clearance positive compensation		0	
SFD909	Gear clearance negative compensation		0	
SFD910	Electrical origin low 16 bits		0	
SFD911	Electrical origin high 16 bits		0	

SFD912	Signal terminal state setting	Bit0: origin signal switch state Bit1: Z phase switch state Bit2: positive limit switch state Bit3: negative limit switch state 0: normally open(positive logic) 1: normally close(negative logic) default is 0	0	Group 1
SFD914	Z phase terminal setting	Bit0~bit7: set X terminal, 0xFF is no terminal(interruption)	0xFF	
SFD915	Limit terminal setting	Bit7~bit0: X terminal of positive limit, 0xFF is no terminal Bit15~bit8: X terminal of negative limit, 0xFF is no terminal	FFFF	
SFD917	Clear signal CLR output terminal	Bit0~Bit7: Y terminal, 0xFF is no terminal	0xFF	
SFD918	Returning speed VH low 16 bits		0	
SFD919	Returning speed VH high 16 bits		0	
SFD922	Crawling speed VC low 16 bits		0	
SFD923	Crawling speed VC high 16 bits		0	
SFD924	Mechanical origin position low 16 bits		0	
SFD925	Mechanical origin position high 16 bits		0	
SFD926	Z phase numbers		0	
SFD927	CLR signal delay time	Default 20, unit: ms	20	
SFD928	Grinding wheel radius(polar coordinate)	Low 16 bits	0	
SFD929		High 16 bits	0	
SFD930	Soft limit positive limit value	Low 16 bits	0	
SFD931		High 16 bits	0	
SFD932	Soft limit negative limit value	Low 16 bits	0	
SFD933		High 16 bits	0	
...				
SFD950	Pulse default speed low 16 bits	It will send pulse with default speed when the speed is 0.	20	
SFD951	Pulse default speed high 16 bits		0	
SFD952	Pulse default speed acceleration time		100	

SFD953	Pulse default speed deceleration time		200
SFD954	Acceleration and deceleration time		0
SFD955	Pulse acceleration and deceleration mode	Bit 1~0: acc/dec mode 00: line 01: S curve 10: sine curve 11: reserved Bit 15~2: reserved	0
SFD956	Max speed limit low 16 bits		100
SFD957	Max speed limit high 16 bits		0
SFD958	Initial speed low 16 bits		0
SFD959	Initial speed high 16 bits		0
SFD960	Stop speed low 16 bits		0
SFD961	Stop speed high 16 bits		0
SFD962	Follow performance parameters	1~100, 100 means the time constant is one tick, 1 means the time constant is 100 tick.	50
SFD963	Follow feedforward compensation	0~100, percentage	0
...			

**Note:**

- ※1: As there are many configuration parameters of PLSR, we suggest to use software configuration table to set the parameters.
- ※2: if user needs to set each segment pulse frequency and pulse numbers in the HMI, please configure through the configuration table first, then use instruction DMOV in the program to set the registers (S0+N\*10+0, S0+N\*10+2).

For example:

```

DMOV  HD200  HD10      //HD200 set segment 1 pulse frequency in HMI
DMOV  HD202  HD12      //HD202 set segment 1 pulse numbers in HMI
DMOV  HD204  HD20      //HD204 set segment 2 pulse frequency in HMI
DMOV  HD206  HD22      //HD206 set segment 2 pulse numbers in HMI

```

It can also set pulse frequency and numbers in registers HD10, HD12, HD20, HD22 directly in the HMI.

**Example 5**

There is a transmission mechanism which includes one servo drive (electronic gear ratio is 1:1), one servo motor (encoder is 2500ppr), it connects the ball screw through a reducer (the reduction ratio is 1:2), the ball screw pitch is 5mm, the ball screw drives a working table which can move left and right. Now it needs to move forth and back on the table, A to B distance is 200mm, A to B speed is 20mm/s, B to A speed is 30mm/s, acceleration time is 100ms, deceleration time is 200ms, the pulse direction terminal is Y2, the mechanical clearance of A to B to A is 3mm, B to A to B is 2mm.

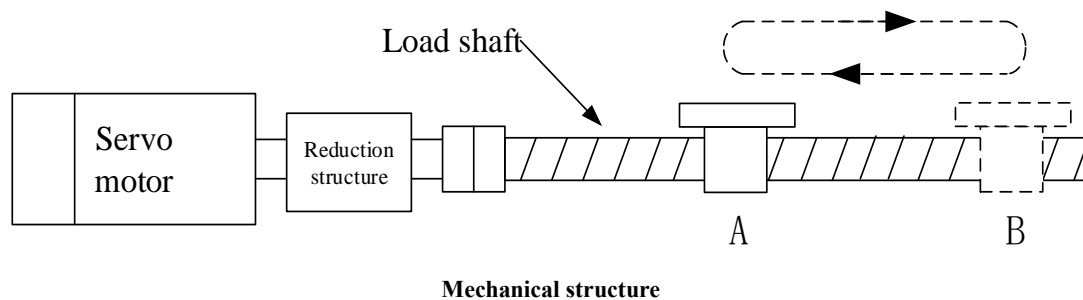

We can calculate the following things:

$$\text{Pulse number per rotate} = 20000 = 2500 * 4 * \frac{2}{1}$$

$$\text{Moving quantity} = \text{pitch} = 5\text{mm}$$

$$20\text{mm/s} = \frac{20\text{mm}}{5\text{mm}} * 20000 = 80000\text{pulse/s}$$

$$30\text{mm/s} = \frac{30\text{mm}}{5\text{mm}} * 20000 = 120000\text{pulse/s}$$

As the acceleration and deceleration time for forward motion and reverse motion is same, but the max frequency is different, so their acceleration and deceleration slope is different.

Forward acceleration slope: 80000Hz/100ms, forward deceleration slope: 80000Hz/200ms.

Reverse acceleration slope: 120000Hz/100ms, reverse deceleration slope: 120000Hz/200ms.

We need to set two groups of parameter as there are two groups of acc/dec slope.

The max frequency is 40K/s and 120K/s, less than 200K/s, so PLC can work normally.

➤ Pulse curve

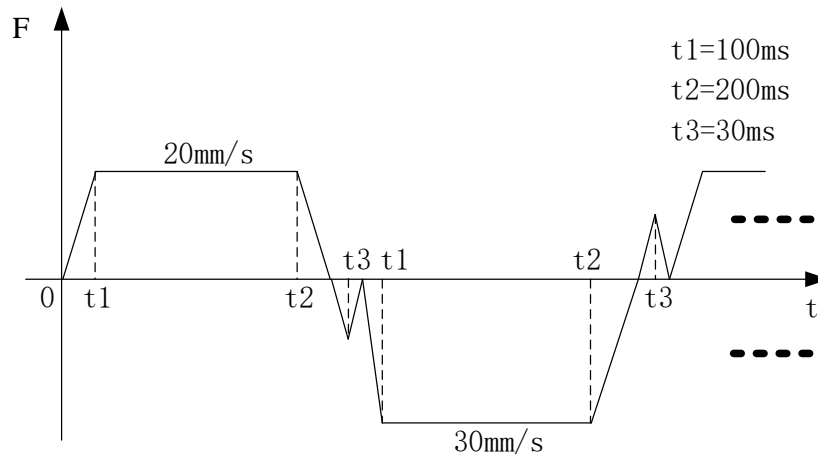

➤ Pulse instruction

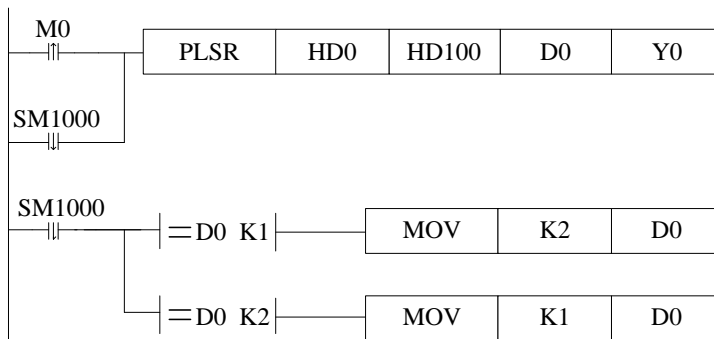

➤ Pulse data configuration

(1) Pulse segment configuration

multi section pulse output ✖

data start address:	HD0	user params address:	HD100	system params:	K1	output:	Y0
mode:	relative ▾	start execute section count:	0	Config			

⋮ Add Delete | Upwards Downwards

	frequence	pulse count	wait condition	wait register	jump register
1	20	200	pulse sending complete	K0	K0
▶ 2	30	-200	pulse sending complete	K0	K0

used space: HD0-HD29,HD100-HD103

Read From PLC
Write To PLC
OK
Cancel

Relative mode

multi section pulse output ✕

data start address: HD0	user params address: HD100	system params: K1	output: Y0
mode: absolut ▼	start execute section count: 0	Config	

⋮ Add Delete | Upwards Downwards

	frequency	pulse count	wait condition	wait register	jump register
1	20	200	pulse sending complete	K0	K0
▶ 2	30	0	pulse sending complete	K0	K0

used space: HD0-HD29,HD100-HD103 Read From PLC Write To PLC OK Cancel

Absolute mode

## (2) System parameters

Param	Value
Y0 axis-Common-Parameters setting-Pulse direction logic	positive logic
Y0 axis-Common-Parameters setting-enable soft limit	disable
Y0 axis-Common-Parameters setting-mechanical back to...	negative
Y0 axis-Common-Parameters setting-Pulse unit	1mm
Y0 axis-Common-Parameters setting-Interpolation coord...	Cross coordi...
Y0 axis-Common-pulse send mode	complete
Y0 axis-Common-Pulse num (1)	20000
Y0 axis-Common-1mm(revolve)	5
Y0 axis-Common-Pulse direction terminal	Y2
Y0 axis-Common-Delayed time of pulse direction (ms)	10

Param	Value
Y0 axis-Common-Gear clearance positive compensation	3
Y0 axis-Common-Gear clearance negative compensation	2
Y0 axis-Common-Electrical origin position	0
Y0 axis-Common-signal terminal switch state setting...	normally on
Y0 axis-Common-signal terminal switch state setting...	normally on
Y0 axis-Common-signal terminal switch state setting...	normally on
Y0 axis-Common-signal terminal switch state setting...	normally on
Y0 axis-Common-Far-point signal terminal setting	X no terminal
Y0 axis-Common-Z phase terminal setting	X no terminal
Y0 axis-Common-positive limit terminal setting	X no terminal



Param	Value
Y0 axis-Common-negative limit terminal setting	X no terminal
Y0 axis-Common-Zero clear CLR output setting	Y no terminal
Y0 axis-Common-Return speed VH	0
Y0 axis-Common-Creeping speed VC	0
Y0 axis-Common-Mechanical zero position	0
Y0 axis-Common-Z phase num	0
Y0 axis-Common-CLR signal delayed time (ms)	20
Y0 axis-Common-grinding wheel radius(polar)	0
Y0 axis-Common-soft limit positive value	0
Y0 axis-Common-soft limit negative value	0

Param	Value
Y0 axis-group 1-Pulse default speed	20
Y0 axis-group 1-Acceleration time of Pulse default s...	100
Y0 axis-group 1-Deceleration time of pulse default s...	200
Y0 axis-group 1-Acceleration and deceleration time (ms)	30
Y0 axis-group 1-pulse acc/dec mode	linear acc/dec
Y0 axis-group 1-Max speed	50
Y0 axis-group 1-Initial speed	0
Y0 axis-group 1-stop speed	0
Y0 axis-group 1-FOLLOW performance param(1-100)	50
Y0 axis-group 1-FOLLOW forward compensation(0-100)	0

Param	Value
Y0 axis-group 2-Pulse default speed	30
Y0 axis-group 2-Acceleration time of Pulse default s...	100
Y0 axis-group 2-Deceleration time of pulse default s...	200
Y0 axis-group 2-Acceleration and deceleration time (ms)	30
Y0 axis-group 2-pulse acc/dec mode	linear acc/dec
Y0 axis-group 2-Max speed	50
Y0 axis-group 2-Initial speed	0
Y0 axis-group 2-stop speed	0
Y0 axis-group 2-FOLLOW performance param(1-100)	50
Y0 axis-group 2-FOLLOW forward compensation(0-100)	0

(3) Pulse data address distribution table(relative mode)

Address	Notes	Value
HD0 (double word)	Pulse total segments (1 to 100)	2
HD2 (8 words)	Reserved	0
HD10 (double words)	Pulse frequency (#1)	20
HD12 (double word)	Pulse number (#1)	200
HD14	bit15~bit8: waiting condition (#1) H00: pulse sending completion H01: wait time H02: wait signal H03: ACT time H04: EXT signal H05: EXT signal or pulse sending completion bit7~bit0: waiting condition register type H00: constant H01: D H02: HD H03: FD H04: X H05: M H06: HM	0
HD15 (double word)	Constant value/ register no. (for waiting condition)(#1)	0
HD17	bit7~bit0: jump register type H00: constant value H01: D H02: HD H03: FD	0
HD+18 (double word)	Constant value/register no. (for jump register)( #1)	0
HD+20 (double word)	Pulse frequency (#2)	20
HD+22 (double word)	Pulse number (#2)	-200
HD+24	Waiting condition, waiting condition register type (#2)	0
HD+25 (double word)	Constant value or register no. (for waiting condition) (#2)	0
HD+27	Jump type, jump register type (#2)	0
HD+28 (double word)	Constant value or register no. (for jump register) (#2)	0

## (4) System parameters

SFD900	Pulse parameter setting	<p>Bit 1: pulse direction logic 0: positive logic 1: negative logic, default is 0</p> <p>Bit 2: use soft limit function 0: not use 1: use default is 0</p> <p>Bit 3: mechanical return to origin direction 0: negative direction 1: positive direction default is 0</p> <p>Bit 10~8: pulse unit</p> <p>Bit8: 0: pulse number 1: equivalent 000: pulse number 001: 1 um 011: 0.01mm 101: 0.1mm 111: 1 mm Default is 000</p> <p>Bit15: interpolation coordinate mode 0: cross coordinate 1: polar coordinate Default is 0</p>	1792	Common parameter
SFD901	Pulse sending mode	<p>Bit 0: pulse sending mode 0: complete mode 1: subsequence mode, default is 0</p>	0	
SFD902	Pulse number/1 rotation low 16 bits		20000	
SFD903	Pulse number/1 rotation high 16 bits		0	
SFD904	Motion quantity/1 rotation low 16 bits		5	
SFD905	Motion quantity/1 rotation high 16 bits		0	
SFD906	Pulse direction terminal	Y terminal no., 0xFF is no terminal	2	
SFD907	Direction delay time	Default is 20, unit: ms	20	
SFD908	Gear clearance positive compensation		0	
SFD909	Gear clearance negative compensation		0	
SFD910	Electrical origin low 16 bits		0	
SFD911	Electrical origin high 16 bits		0	

SFD912	Signal terminal state setting	Bit0: origin signal switch state Bit1: Z phase switch state Bit2: positive limit switch state Bit3: negative limit switch state 0: normally open(positive logic) 1: normally close(negative logic) default is 0	0	Group 1
SFD914	Z phase terminal setting	Bit0~bit7: set X terminal, 0xFF is no terminal(interruption)	0xFF	
SFD915	Limit terminal setting	Bit7~bit0: X terminal of positive limit, 0xFF is no terminal Bit15~bit8: X terminal of negative limit, 0xFF is no terminal	FFFF	
SFD917	Clear signal CLR output terminal	Bit0~Bit7: Y terminal, 0xFF is no terminal	0xFF	
SFD918	Returning speed VH low 16 bits		0	
SFD919	Returning speed VH high 16 bits		0	
SFD922	Crawling speed VC low 16 bits		0	
SFD923	Crawling speed VC high 16 bits		0	
SFD924	Mechanical origin position low 16 bits		0	
SFD925	Mechanical origin position high 16 bits		0	
SFD926	Z phase numbers		0	
SFD927	CLR signal delay time	Default 20, unit: ms	20	
SFD928	Grinding wheel radius(polar coordinate)	Low 16 bits	0	
SFD929		High 16 bits	0	
SFD930	Soft limit positive limit value	Low 16 bits	0	
SFD931		High 16 bits	0	
SFD932	Soft limit negative limit value	Low 16 bits	0	
SFD933		High 16 bits	0	
...				
SFD950	Pulse default speed low 16 bits	It will send pulse with default speed when the speed is 0.	20	
SFD951	Pulse default speed high 16 bits		0	
SFD952	Pulse default speed acceleration time		100	

SFD953	Pulse default speed deceleration time		200	Group 2
SFD954	Acceleration and deceleration time		30	
SFD955	Pulse acceleration and deceleration mode	Bit 1~0: acc/dec mode 00: line 01: S curve 10: sine curve 11: reserved Bit 15~2: reserved	0	
SFD956	Max speed limit low 16 bits		50	
SFD957	Max speed limit high 16 bits		0	
SFD958	Initial speed low 16 bits		0	
SFD959	Initial speed high 16 bits		0	
SFD960	Stop speed low 16 bits		0	
SFD961	Stop speed high 16 bits		0	
SFD962	Follow performance parameters	1~100, 100 means the time constant is one tick, 1 means the time constant is 100 tick.	50	
SFD963	Follow feedforward compensation	0~100, percentage	0	
...				
SFD970	Pulse default speed low 16 bits	It will send pulse with default speed when the speed is 0.	30	
SFD971	Pulse default speed high 16 bits		0	
SFD972	Pulse default speed acceleration time		100	
SFD973	Pulse default speed deceleration time		200	
SFD974	Acceleration and deceleration time		30	
SFD975	Pulse acceleration and deceleration mode	Bit 1~0: acc/dec mode 00: line 01: S curve 10: sine curve 11: reserved Bit 15~2: reserved	0	
SFD976	Max speed limit low 16 bits		50	
SFD977	Max speed limit high 16 bits		0	
SFD978	Initial speed low 16 bits		0	
SFD979	Initial speed high 16 bits		0	
SFD980	Stop speed low 16 bits		0	

SFD981	Stop speed high 16 bits		0
SFD982	Follow performance parameters	1~100, 100 means the time constant is one tick, 1 means the time constant is 100 tick.	50
SFD983	Follow feedforward compensation	0~100, percentage	0
...			

**Note:**

※1: As there are many configuration parameters of PLSR, we suggest to use software configuration table to set the parameters.

※2: if user needs to set each segment pulse frequency and pulse numbers in the HMI, please configure through the configuration table first, then use instruction DMOV in the program to set the registers (S0+N\*10+0, S0+N\*10+2).

For example:

```

DMOV  HD200  HD10      //HD200 set segment 1 pulse frequency in HMI
DMOV  HD202  HD12      //HD202 set segment 1 pulse numbers in HMI
DMOV  HD204  HD20      //HD204 set segment 2 pulse frequency in HMI
DMOV  HD206  HD22      //HD206 set segment 2 pulse numbers in HMI

```

It can also set pulse frequency and numbers in registers HD10, HD12, HD20, HD22 directly in the HMI.

### 1-2-3. Variable frequency pulse output [PLSF]

#### ■ Instruction summarization

Variable frequency pulse output instruction.

Variable frequency pulse output [PLSF]			
16-bit	-	32-bit instruction	PLSF
Execution condition	Normally open/close coil	Suitable mode	XD, XL (except XD1, XL1)
Hardware	-	Software	-

#### ■ Operand

Operand	Function	Type
S0	Pulse frequency	32-bit, double word
S1	System parameters (1 to 4)	32-bit, double word
D	Pulse output terminal	Bit

### ■ Suitable soft component

word	Operand	System								Constant	Module	
		D*	FD	TD*	CD*	DX	DY	DM*	DS*	K/H	ID	QD
S0		•	•	•	•	•	•	•	•	•		
S1		•	•							•		

bit	Operand	System						
		X	Y	M*	S*	T*	C*	Dnm
D			•					

\*Note: D means D, HD. TD means TD, HTD. CD means CD, HCD, HSCD, HSD. DM means DM, DHM.

DS means DS, DHS. M means M, HM, SM. S means S, HS. T means T, HT. C means C, HC.

### Function and action

Instruction mode:

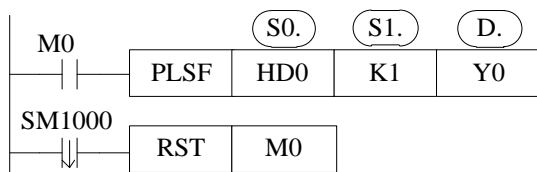

- Frequency range: 1Hz ~100KHz or -100KHz ~ -1Hz (note: PLC can output 100~200KHz pulse, but we cannot ensure all the servo drive can work fine, please connect 500 Ω resistor between output terminal and 24V power supply)
- When the frequency is positive, it outputs pulse in forward direction, when the frequency is negative, it outputs pulse in reverse direction
- Pulse direction terminal is set in system parameters
- The pulse frequency outputting from Y terminal will change as the S0 value
- HSD0 (double word) is cumulative pulse numbers, HSD2 (double word) is cumulative equivalentents
- The frequency jump (acceleration/deceleration) will dynamic adjust as pulse rising or falling slope (refer to chapter 1-2-1-3)
- The system parameters are same to PLSR, refer to chapter 1-2-1-3

### Output mode

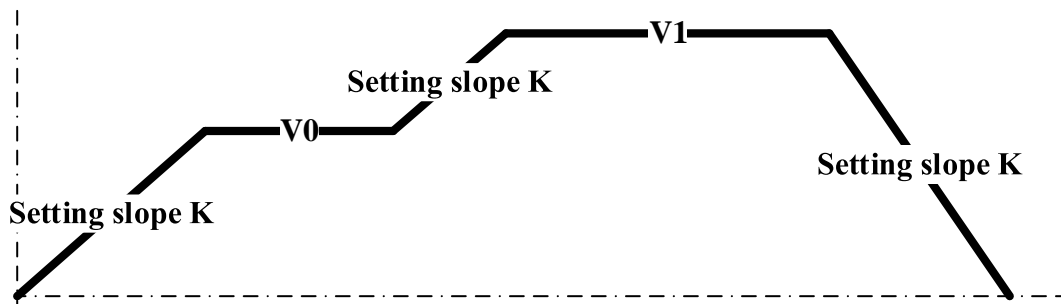

- The pulse output terminal is set in system parameters (refer to chapter 6-2-1-3)
- When the frequency is positive, it outputs pulse in forward direction, when the frequency is negative, it outputs pulse in reverse direction
- When S0 is 0, PLSF stop pulse outputting.
- It will dynamic adjust pulse curve according to pulse slope and setting frequency. If the setting frequency is 0, pulse will stop outputting. And it will output pulses when setting frequency is non-zero value.

**Switching mode analysis**

(A) Pulse default speed acceleration deceleration time is 0  
 The pulse frequency will change as setting frequency.

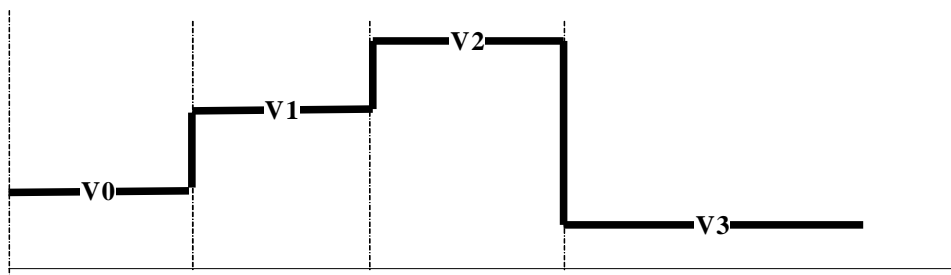

(B) Pulse default speed acceleration deceleration time is not 0  
 (1) the pulse is in stable segment when user setting new frequency, it will switch to setting frequency through the slope.

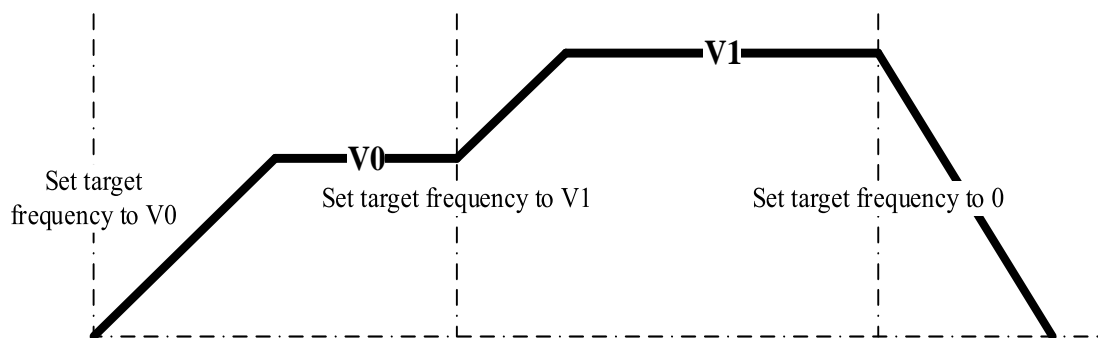



(2) the pulse is not in stable segment when user setting new frequency, it will switch to setting frequency through the slope. (present setting frequency > last time setting frequency, takes present setting frequency as target).

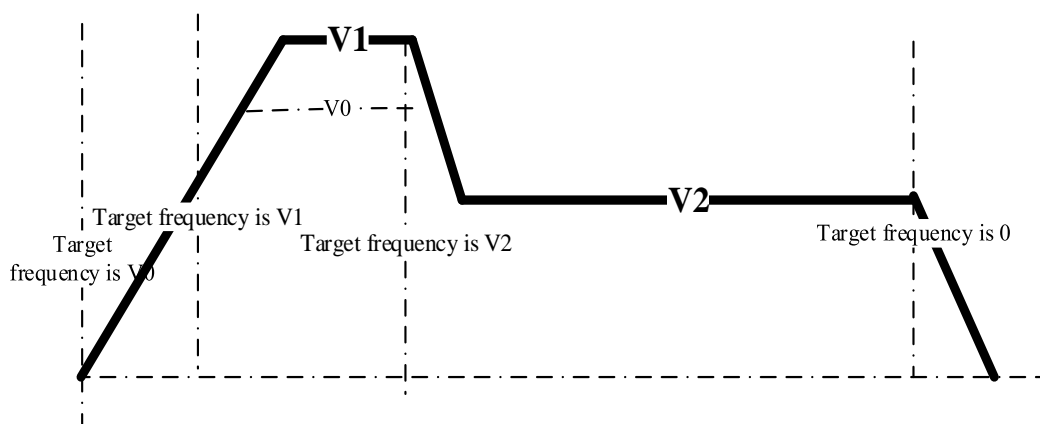

User set target frequency  $V1$  ( $V1 > V0$ ) before reaching setting frequency  $V0$ , at this time, it will go to new setting frequency  $V1$  as the slope.

(3) the pulse is not in stable segment when user setting new frequency, it will switch to setting frequency through the slope. (present setting frequency < last time setting frequency, and present setting frequency < present frequency). setting frequency as target).

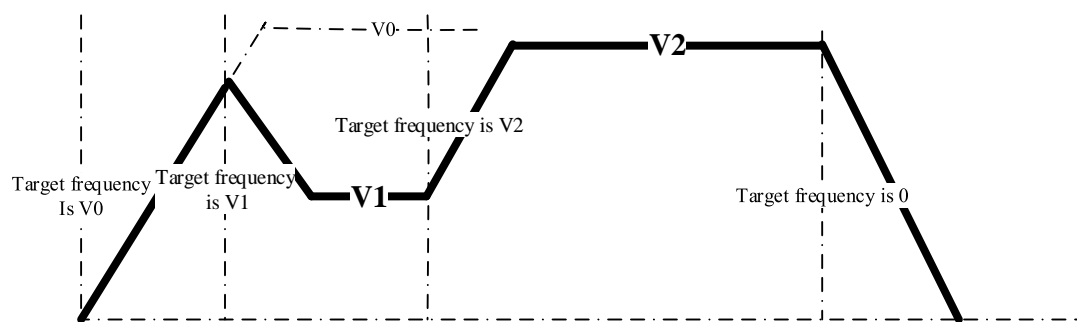

User set target frequency  $V1$  ( $V1 < V0$ ,  $V1 < \text{present frequency}$ ) before reaching setting frequency  $V0$ , at this time, it will go to new setting frequency  $V1$  as the down slope.

### Example 1

As below diagram, the working table needs to move from left to right position X10. Now the position X0 to X10 all installed proximity switch. The speed from left to X0 is  $V0$ , X0 to X1 speed is  $V1$ , X1 to X2 speed is  $V2$ , X2 to X3 speed is  $V3$ , X3 to X4 speed is  $V4$ , X4 to X5 speed is  $V5$ , X5 to X6 speed is  $V6$ , X6 to X7 speed is  $V7$ , X7 to X10 speed is  $V8$ . Acceleration/deceleration slope is 1000Hz/100ms. Pulse direction terminal is Y2.

No.	Speed name	Speed	No.	Speed name	speed
1	V0	1000Hz	6	V5	6000Hz
2	V1	2000Hz	7	V6	7000Hz
3	V2	3000Hz	8	V7	8000Hz
4	V3	4000Hz	9	V8	9000Hz
5	V4	5000Hz			

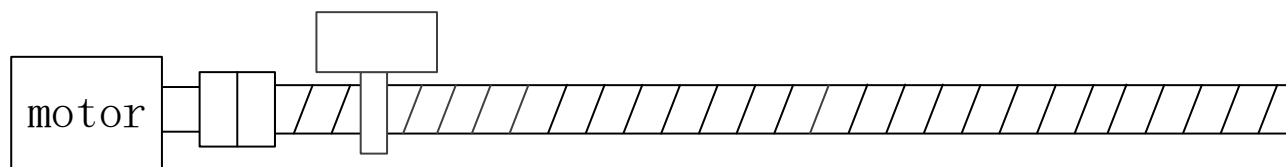

V0 ■ V1 ■ V2 ■ V3 ■ V4 ■ V5 ■ V6 ■ V7 ■ V8 ■  
X0 X1 X2 X3 X4 X5 X6 X7 X10

### Mechanical structure

➤ Pulse curve

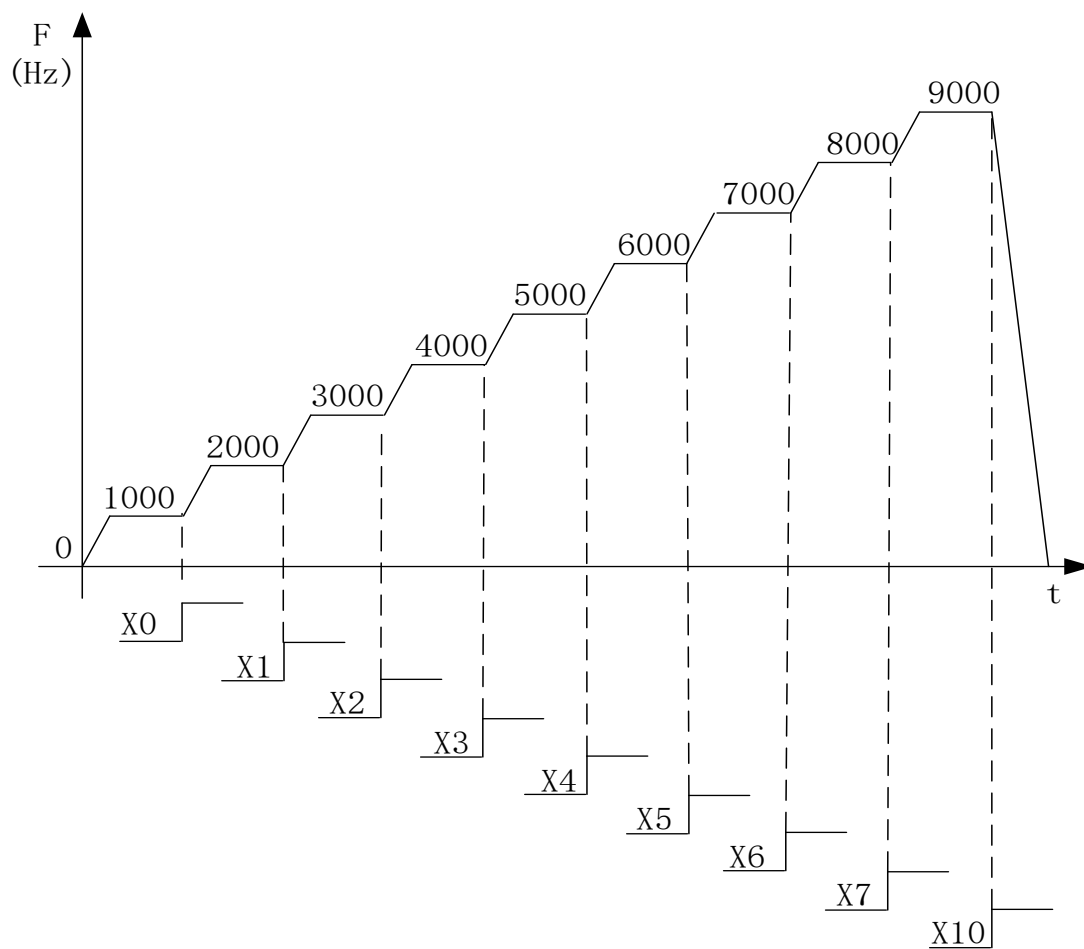

➤ Pulse instruction

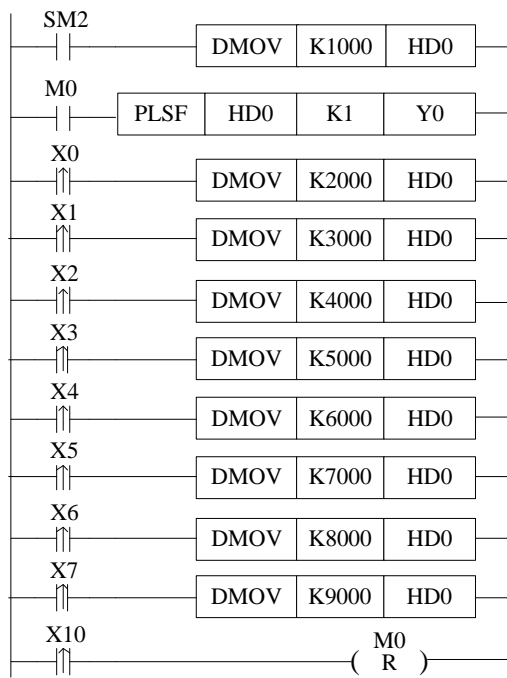

➤ Software configuration

(1) Pulse segment configuration

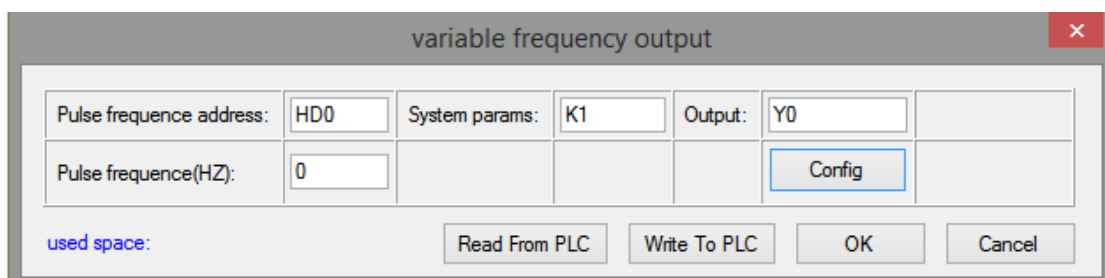

(2) System parameter configuration (relative mode)

Param	Value
Y0 axis-Common-Parameters setting-Pulse direction logic	positive logic
Y0 axis-Common-Parameters setting-enable soft limit	disable
Y0 axis-Common-Parameters setting-mechanical back to...	negative
Y0 axis-Common-Parameters setting-Pulse unit	pulse number
Y0 axis-Common-Parameters setting-Interpolation coord...	Cross coordi...
Y0 axis-Common-pulse send mode	complete
Y0 axis-Common-Pulse num (1)	1
Y0 axis-Common-Offset (1)	1
Y0 axis-Common-Pulse direction terminal	Y2
Y0 axis-Common-Delayed time of pulse direction (ms)	10

Param	Value
Y0 axis-Common-Gear clearance positive compensation	0
Y0 axis-Common-Gear clearance negative compensation	0
Y0 axis-Common-Electrical origin position	0
Y0 axis-Common-signal terminal switch state setting...	normally on
Y0 axis-Common-signal terminal switch state setting...	normally on
Y0 axis-Common-signal terminal switch state setting...	normally on
Y0 axis-Common-signal terminal switch state setting...	normally on
Y0 axis-Common-Far-point signal terminal setting	X no terminal
Y0 axis-Common-Z phase terminal setting	X no terminal
Y0 axis-Common-positive limit terminal setting	X no terminal

Param	Value
Y0 axis-Common-negative limit terminal setting	X no terminal
Y0 axis-Common-Zero clear CLR output setting	Y no terminal
Y0 axis-Common-Return speed VH	0
Y0 axis-Common-Creeping speed VC	0
Y0 axis-Common-Mechanical zero position	0
Y0 axis-Common-Z phase num	0
Y0 axis-Common-CLR signal delayed time (ms)	20
Y0 axis-Common-grinding wheel radius(polar)	0
Y0 axis-Common-soft limit positive value	0
Y0 axis-Common-soft limit negative value	0

Param	Value
Y0 axis-group 1-Pulse default speed	1000
Y0 axis-group 1-Acceleration time of Pulse default s...	100
Y0 axis-group 1-Deceleration time of pulse default s...	100
Y0 axis-group 1-Acceleration and deceleration time (ms)	0
Y0 axis-group 1-pulse acc/dec mode	linear acc/dec
Y0 axis-group 1-Max speed	200000
Y0 axis-group 1-Initial speed	0
Y0 axis-group 1-stop speed	0
Y0 axis-group 1-FOLLOW performance param(1-100)	50
Y0 axis-group 1-FOLLOW forward compensation(0-100)	0

(3) System parameters address:

SFD900	Pulse parameter setting	<p>Bit 1: pulse direction logic 0: positive logic 1: negative logic, default is 0</p> <p>Bit 2: use soft limit function 0: not use 1: use default is 0</p> <p>Bit 3: mechanical return to origin direction 0: negative direction 1: positive direction default is 0</p> <p>Bit 10~8: pulse unit Bit8: 0: pulse number 1: equivalent 000: pulse number 001: 1 um 011: 0.01mm 101: 0.1mm 111: 1 mm Default is 000</p> <p>Bit15: interpolation coordinate mode 0: cross coordinate 1: polar coordinate Default is 0</p>	0	Common parameter
SFD901	Pulse sending mode	<p>Bit 0: pulse sending mode 0: complete mode 1: subsequence mode, default is 0</p>		
SFD902	Pulse number/1 rotation low 16 bits		0	
SFD903	Pulse number/1 rotation high 16 bits		0	
SFD904	Motion quantity/1 rotation low 16 bits		0	
SFD905	Motion quantity/1 rotation high 16 bits		0	
SFD906	Pulse direction terminal	Y terminal no., 0xFF is no terminal	2	
SFD907	Direction delay time	Default is 20, unit: ms	20	
SFD908	Gear clearance positive compensation		0	
SFD909	Gear clearance negative compensation		0	
SFD910	Electrical origin low 16 bits		0	
SFD911	Electrical origin high 16 bits		0	

SFD912	Signal terminal state setting	Bit0: origin signal switch state Bit1: Z phase switch state Bit2: positive limit switch state Bit3: negative limit switch state 0: normally open(positive logic) 1: normally close(negative logic) default is 0	0	Group 1
SFD914	Z phase terminal setting	Bit0~bit7: set X terminal, 0xFF is no terminal(interruption)	0xFF	
SFD915	Limit terminal setting	Bit7~bit0: X terminal of positive limit, 0xFF is no terminal Bit15~bit8: X terminal of negative limit, 0xFF is no terminal	FFFF	
SFD917	Clear signal CLR output terminal	Bit0~Bit7: Y terminal, 0xFF is no terminal	0xFF	
SFD918	Returning speed VH low 16 bits		0	
SFD919	Returning speed VH high 16 bits		0	
SFD922	Crawling speed VC low 16 bits		0	
SFD923	Crawling speed VC high 16 bits		0	
SFD924	Mechanical origin position low 16 bits		0	
SFD925	Mechanical origin position high 16 bits		0	
SFD926	Z phase numbers		0	
SFD927	CLR signal delay time	Default 20, unit: ms	20	
SFD928	Grinding wheel radius(polar coordinate)	Low 16 bits	2	
SFD929		High 16 bits	0	
SFD930	Soft limit positive limit value	Low 16 bits	0	
SFD931		High 16 bits	0	
SFD932	Soft limit negative limit value	Low 16 bits	0	
SFD933		High 16 bits	0	
...				
SFD950	Pulse default speed low 16 bits	It will send pulse with default speed when the speed is 0.	1000	
SFD951	Pulse default speed high 16 bits		0	
SFD952	Pulse default speed acceleration time		100	

SFD953	Pulse default speed deceleration time		100
SFD954	Acceleration and deceleration time		0
SFD955	Pulse acceleration and deceleration mode	Bit 1~0: acc/dec mode 00: line 01: S curve 10: sine curve 11: reserved Bit 15~2: reserved	0
SFD956	Max speed limit low 16 bits		3392
SFD957	Max speed limit high 16 bits		3
SFD958	Initial speed low 16 bits		0
SFD959	Initial speed high 16 bits		0
SFD960	Stop speed low 16 bits		0
SFD961	Stop speed high 16 bits		0
SFD962	Follow performance parameters	1~100, 100 means the time constant is one tick, 1 means the time constant is 100 tick.	0
SFD963	Follow feedforward compensation	0~100, percentage	0
...			

**Note:**

※1: As there are many configuration parameters of PLSF, we suggest to use software configuration table to set the parameters.

**Example 2**

As below diagram, the AD module collects 0-10V voltage signal and transforms to digital value 0-16383, this value will be sent to PLSF pulse frequency register, and PLC will output the pulse curve changing as the voltage signal.

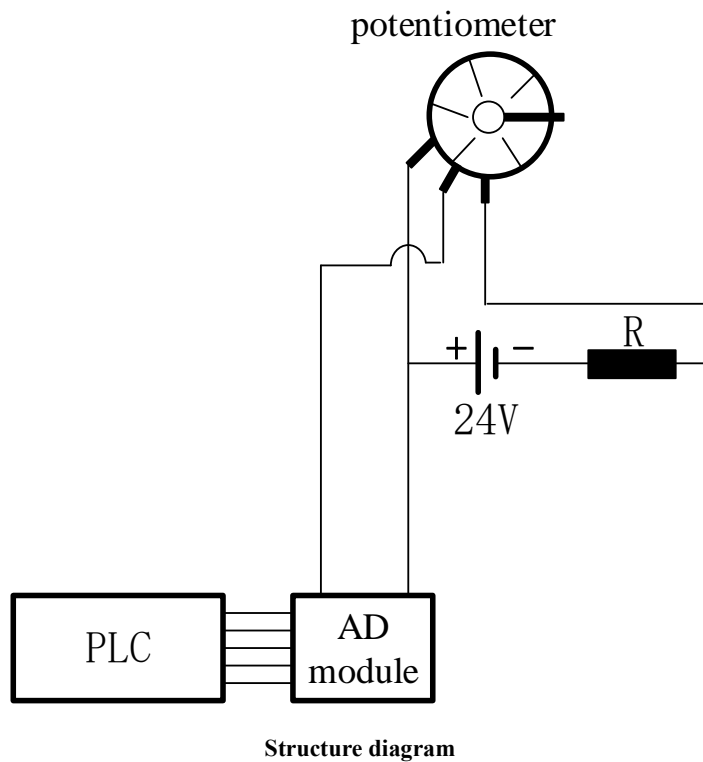

For example: the output signal of potentiometer is shown as below:

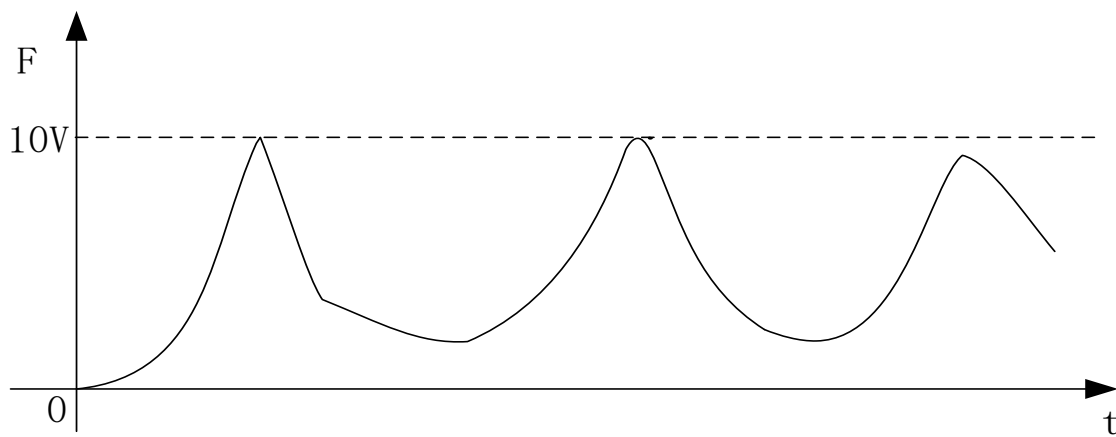

voltage signal diagram

The transformed digital value is 0 to 16383 of 0-10V voltage signal, which means the pulse frequency is 0~16383Hz (because of the response problem, PLSF acceleration deceleration time is 0). The relationship of voltage signal, digital value and pulse output frequency is shown as below diagram:



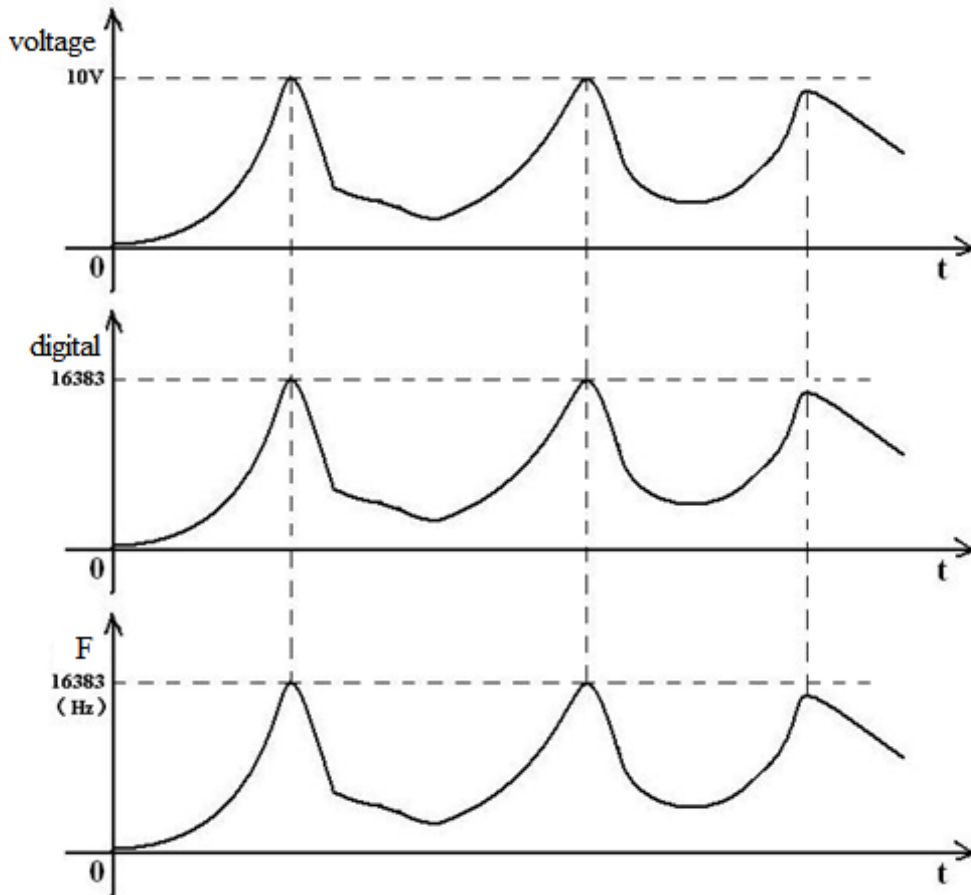

Relationship of voltage signal/digital value/pulse frequency

➤ Pulse instruction

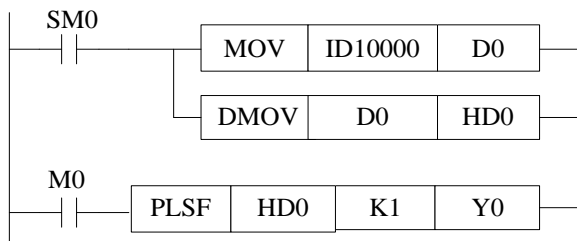

➤ Software configuration

(1) Pulse segment configuration

variable frequency output ✕

Pulse frequency address:	HD0	System params:	K1	Output:	Y0	
Pulse frequency(HZ):	0				Config	

used space: Read From PLC   Write To PLC   **OK**   Cancel

## (2) System parameters (relative mode)

Param	Value
Y0 axis-Common-Parameters setting-Pulse direction logic	positive logic
Y0 axis-Common-Parameters setting-enable soft limit	disable
Y0 axis-Common-Parameters setting-mechanical back to...	negative
Y0 axis-Common-Parameters setting-Pulse unit	pulse number
Y0 axis-Common-Parameters setting-Interpolation coord...	Cross coordi...
Y0 axis-Common-pulse send mode	complete
Y0 axis-Common-Pulse num (1)	1
Y0 axis-Common-Offset (1)	1
Y0 axis-Common-Pulse direction terminal	Y2
Y0 axis-Common-Delayed time of pulse direction (ms)	10

Param	Value
Y0 axis-Common-Gear clearance positive compensation	0
Y0 axis-Common-Gear clearance negative compensation	0
Y0 axis-Common-Electrical origin position	0
Y0 axis-Common-signal terminal switch state setting...	normally on
Y0 axis-Common-signal terminal switch state setting...	normally on
Y0 axis-Common-signal terminal switch state setting...	normally on
Y0 axis-Common-signal terminal switch state setting...	normally on
Y0 axis-Common-Far-point signal terminal setting	X no terminal
Y0 axis-Common-Z phase terminal setting	X no terminal
Y0 axis-Common-positive limit terminal setting	X no terminal

Param	Value
Y0 axis-Common-negative limit terminal setting	X no terminal
Y0 axis-Common-Zero clear CLR output setting	Y no terminal
Y0 axis-Common-Return speed VH	0
Y0 axis-Common-Creeping speed VC	0
Y0 axis-Common-Mechanical zero position	0
Y0 axis-Common-Z phase num	0
Y0 axis-Common-CLR signal delayed time (ms)	20
Y0 axis-Common-grinding wheel radius(polar)	0
Y0 axis-Common-soft limit positive value	0
Y0 axis-Common-soft limit negative value	0

Param	Value
Y0 axis-group 1-Pulse default speed	0
Y0 axis-group 1-Acceleration time of Pulse default s...	0
Y0 axis-group 1-Deceleration time of pulse default s...	0
Y0 axis-group 1-Acceleration and deceleration time (ms)	0
Y0 axis-group 1-pulse acc/dec mode	linear acc/dec
Y0 axis-group 1-Max speed	200000
Y0 axis-group 1-Initial speed	0
Y0 axis-group 1-stop speed	0
Y0 axis-group 1-FOLLOW performance param(1-100)	50
Y0 axis-group 1-FOLLOW forward compensation(0-100)	0

**Note:**

※1: As there are many configuration parameters of PLSF, we suggest to use software configuration table to set the parameters.

#### 1-2-4. Relative single segment positioning [DRVI]

##### ■ Instruction overview

Relative single segment positioning pulse instruction.

Relative single segment positioning [DRVI]			
16-bit instruction	-	32-bit instruction	DRVI
Execution condition	Rising/falling edge coil	Suitable model	XD, XL (except XD1, XL1)
Hardware	V3.3.1 and up	Software	V3.3 and up

##### ■ Operand

Operand	Function	Type
S0	Pulse numbers or soft component address	32-bit, BIN
S1	Pulse frequency or soft component address	32-bit, BIN
S2	Pulse acceleration/deceleration time or soft component address	32-bit, BIN
D0	Pulse output terminal	Bit
D1	Pulse direction terminal	Bit

■ Suitable soft component

Word	Operand	System							Constant	Module	
		D*	FD	TD*	CD*	DX	DY	DM*	DS*	K/H	ID
	S0	•	•	•	•	•	•	•	•		
	S1	•	•	•	•	•	•	•	•		
S2	•	•	•	•	•	•	•	•			
Bit	Operand	System									
		X	Y	M*	S*	T*	C*	Dnm			
	D1		•								
	D2		•								

\*Note: D means D, HD. TD means TD, HTD. CD means CD, HCD, HSCD, HSD. DM means DM, DHM. DS means DS, DHS. M means M, HM, SM. S means S, HS. T means T, HT. C means C, HC.

**Function and action**

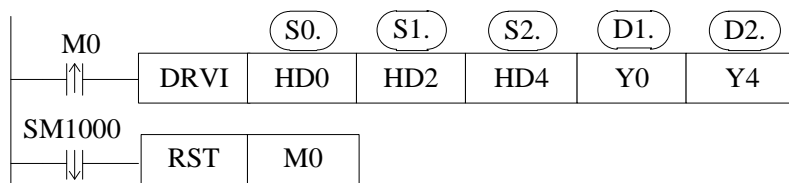

- Pulse frequency output range: 1Hz ~100KHz (note: PLC can output 100~200KHz pulse, but we cannot ensure all the servo drive can work fine, please connect 500Ω resistor between output terminal and 24V power supply)
- Pulse numbers: K-2,147,483,648 ~ K2,147,483,647; negative value means output pulse in reverse direction.
- Relative driving mode: move from the present position (the distance between present position and target position), HSD0, HSD2, HSD4, HSD6..... are the reference point.

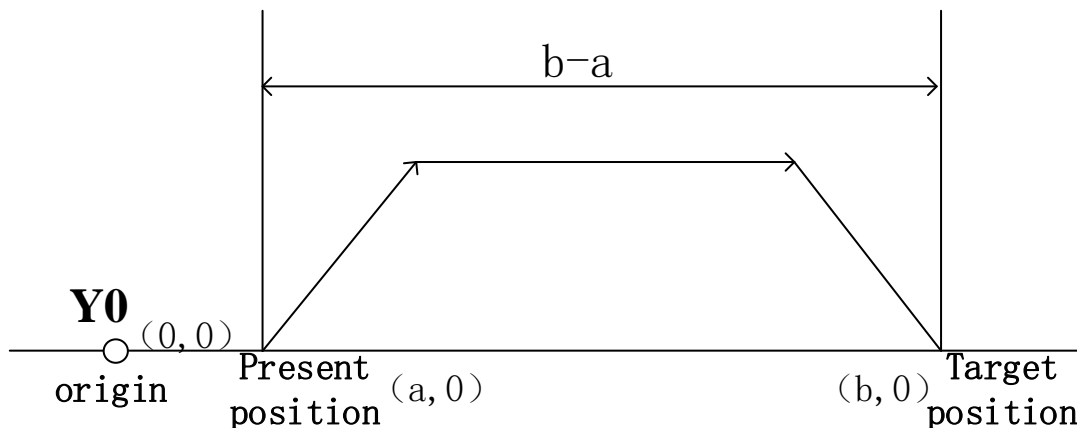

- The pulse number is accumulated in register HSD0 (double word).
- The pulse frequency can be real-time changed when the instruction is executing, the new frequency will be effective at once. (PLC firmware v3.4.5 and up can support)
- The acceleration and deceleration time is same for DRVI instruction.
- The direction of relative positioning instruction depends on S0 (pulse number), if the number of pulses is set to a positive value, the pulse is sent in forward direction and the accumulative pulse register (HSD0, HSD4...) value increases; if the number of pulses is set to a negative value, the pulse is sent in reverse direction and the accumulative pulse register (HSD0, HSD4...) value decreases.
- DRVI does not use the system parameter block configuration mode, if the public and the first set of parameters (except the deceleration parameters) are configured, they will be effective for DRVI.

**Example 1**

X axis present coordinates is (100, 0), it needs to move to target position (3000, 0) with the speed 1000Hz, start frequency and end frequency is 0Hz, pulse output terminal is Y0, direction terminal is Y4. As HSD0(dword) present value is 100, the relative distance from target position 3000 to present position 100 is  $3000-100=2900$ . The execution diagram of DRVI is shown as below:

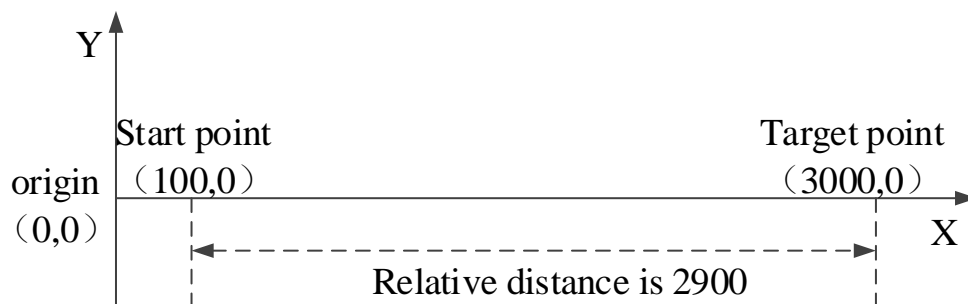

Pulse coordinates diagram

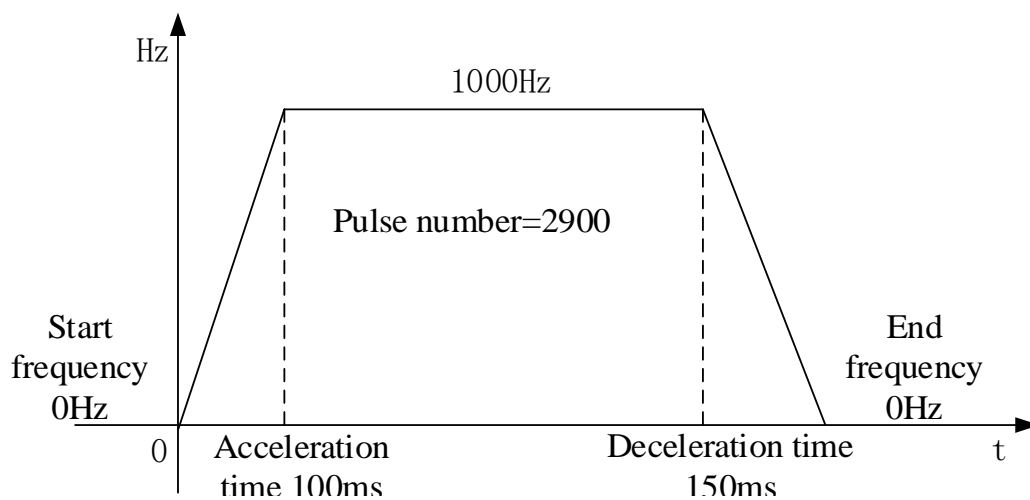

Pulse curve diagram

➤ **Program:**

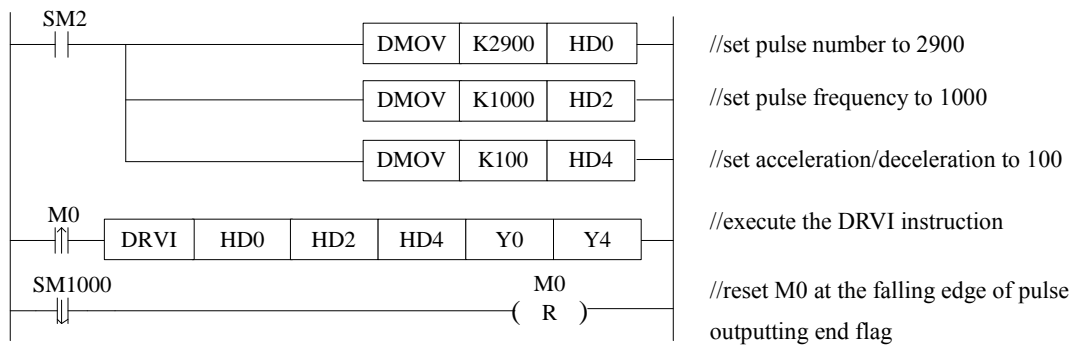

**Example 2**

X axis present coordinates is (3000, 0), it needs to move to target position (100, 0) with the speed 1000Hz, start frequency and end frequency is 0Hz, pulse output terminal is Y0, direction terminal is Y4. As HSD0(dword) present value is 3000, the relative distance from target position 100 to present position 3000 is  $100-3000=-2900$ . The execution diagram of DRVI is shown as below:

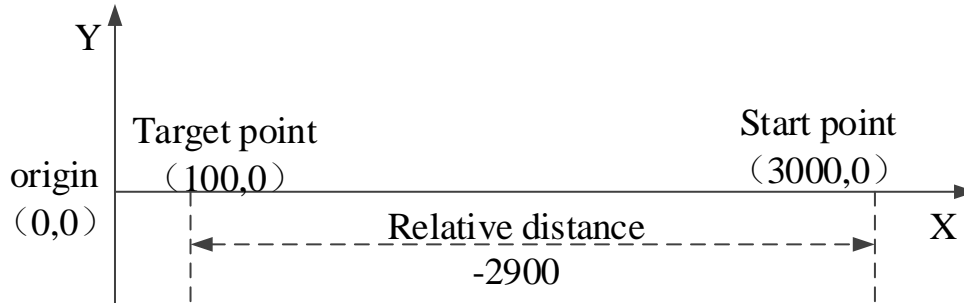

**Pulse coordinate diagram**

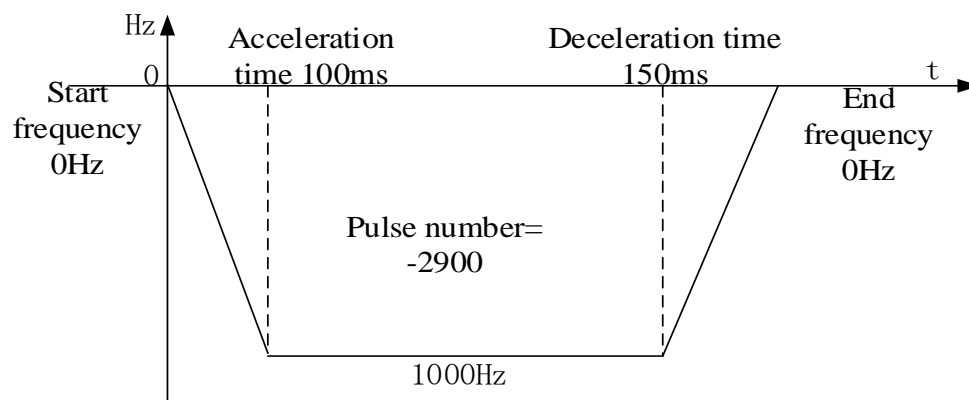

**Pulse curve diagram**

➤ Program:

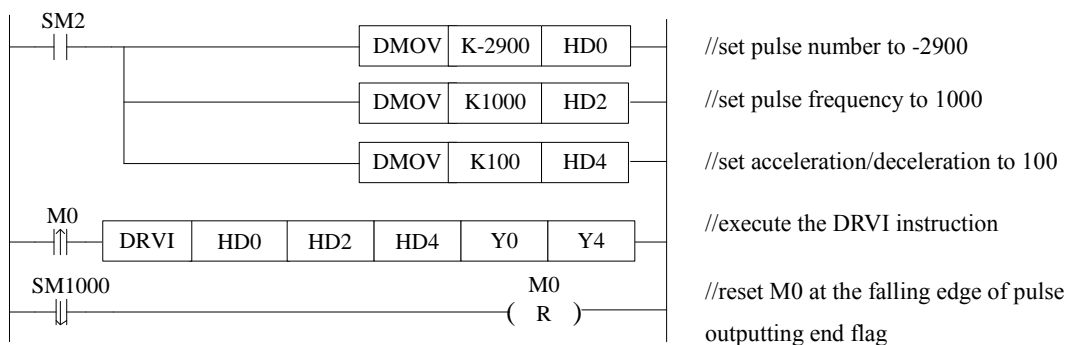

**Example 3**

There is a ball screw workbench, the motor has 5000 pulses per circle, X axis present coordinate is (100mm, 0), start speed and end speed is 0mm/s, it needs to reach the target position (220mm, 0) with the speed 15000 (30mm/s), the pulse output terminal is Y0, pulse direction terminal is Y4, as the accumulated pulse number register HSD0 present value is 50000 (100mm), the relative distance from target position 110000 (220mm) to present position 50000 (100mm) is 60000=110000-50000. The execution diagram of DRVI is shown as below:

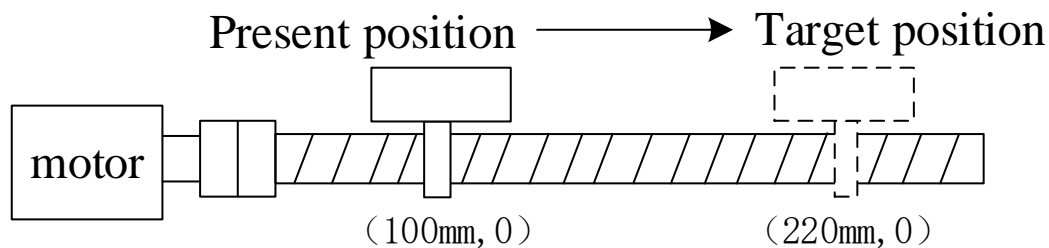

Ball screw pitch: 10mm

Ball screw diagram

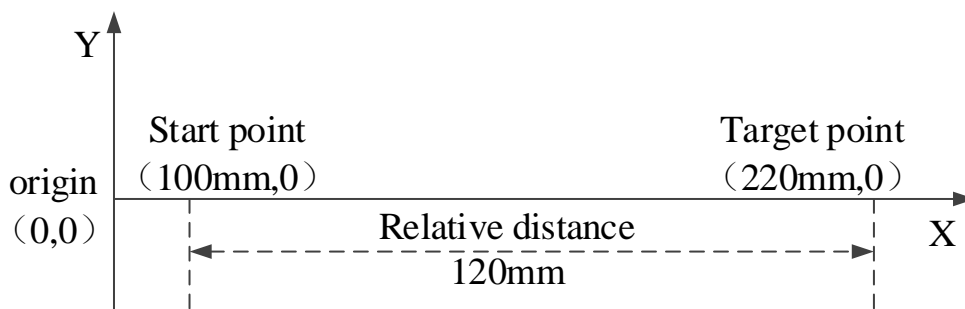

Pulse coordinate diagram

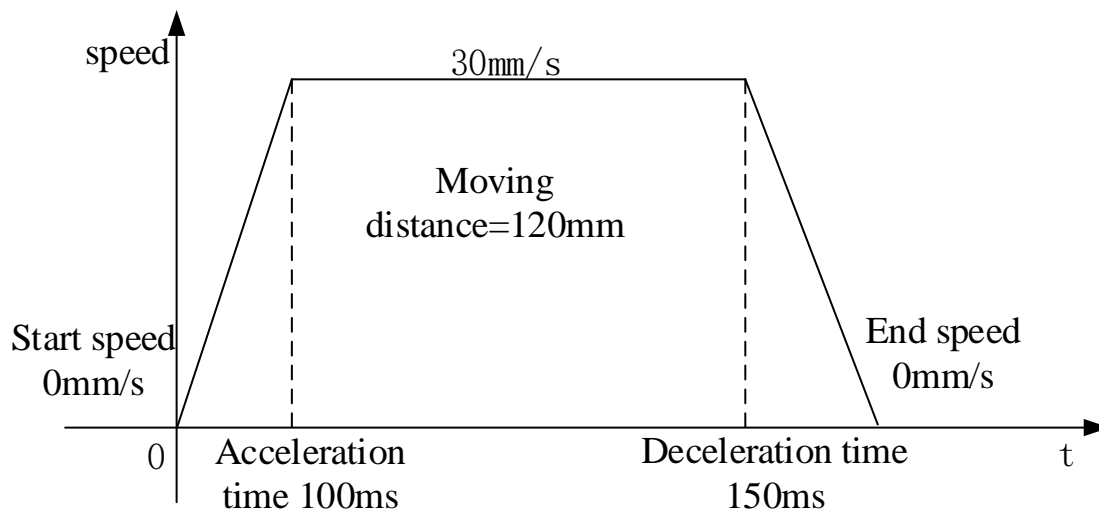

pulse curve diagram

➤ **Program:**

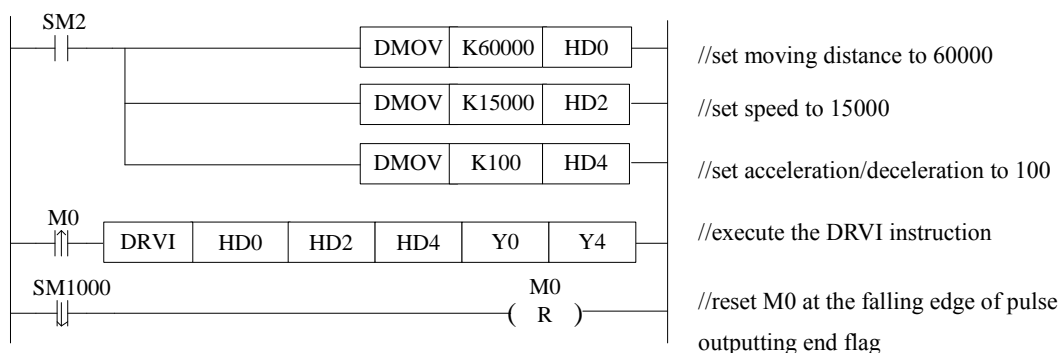

**Example 4**

There is a ball screw workbench, the motor has 5000 pulses per circle, X axis present coordinate is (220mm, 0), start speed and end speed is 0mm/s, it needs to reach the target position (100mm, 0) with the speed 15000 (30mm/s), the pulse output terminal is Y0, pulse direction terminal is Y4, as the accumulated pulse number register HSD0 present value is 110000 (220mm), the relative distance from target position 50000 (100mm) to present position 110000 (220mm) is  $-60000=50000-110000$ . The execution diagram of DRVI is shown as below:



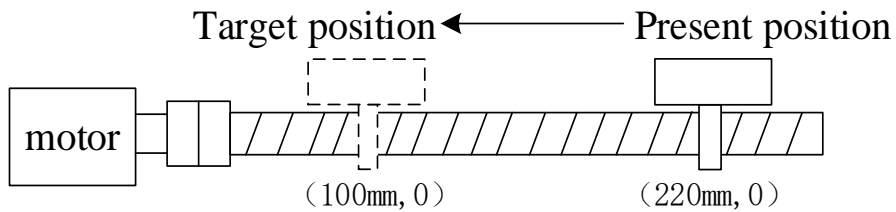

Ball screw pitch: 10mm

Ball screw diagram

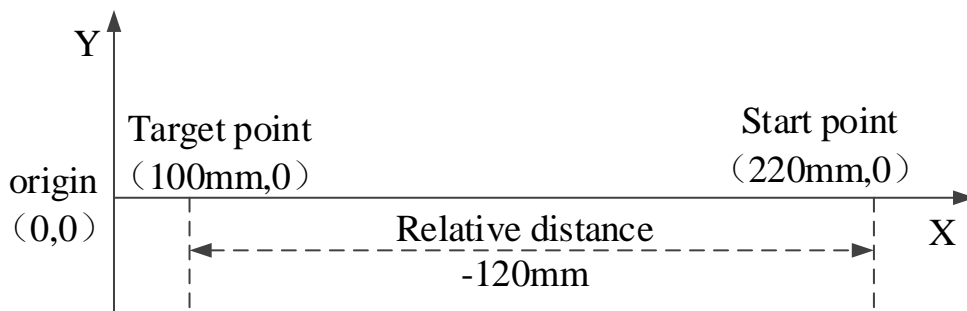

Pulse coordinate diagram

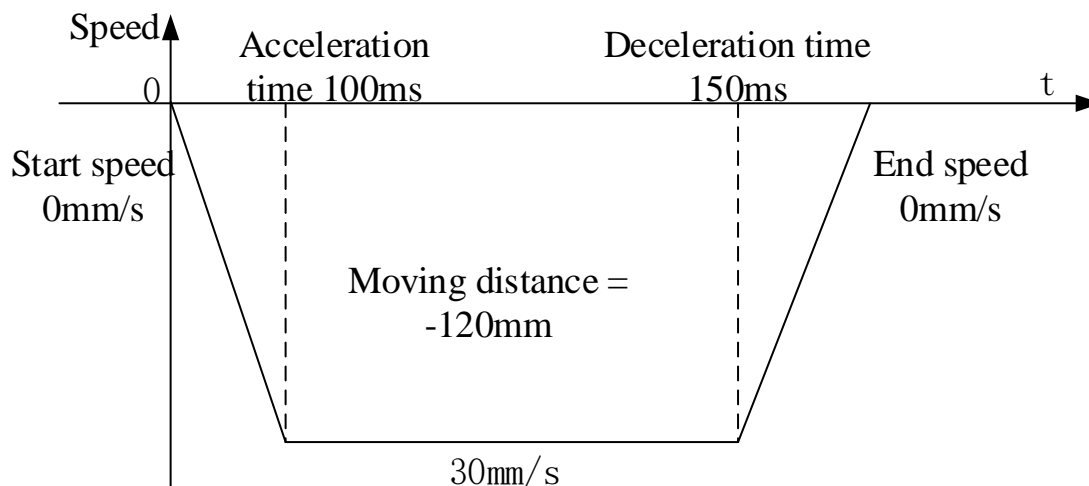

Pulse curve diagram

➤ **Program:**

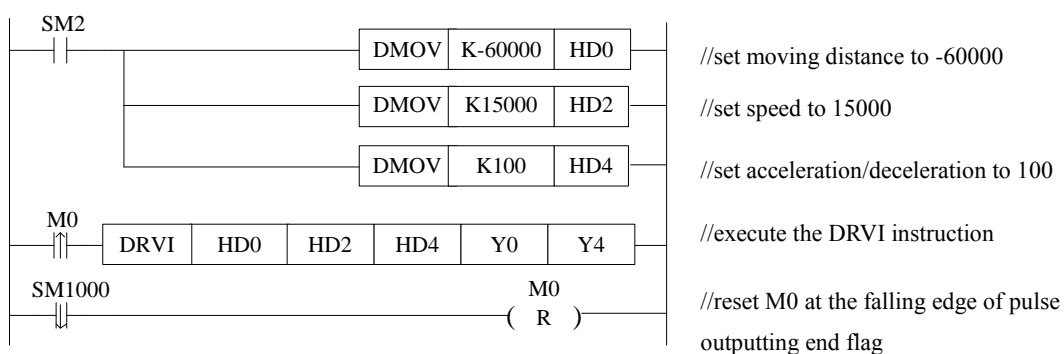

### 1-2-5. Absolute single-segment positioning [DRVA]

#### 1. Instruction summarization

Absolute single-segment positioning instruction.

Absolute single-segment positioning [DRVA]			
16-bit instruction	-	32-bit instruction	DRVA
Execution condition	Rising/falling edge of the coil	Suitable model	XD, XL (except XD1, XL1)
Hardware	V3.3.1 and up	Software	V3.3 and up

#### 2. operand

Operand	Function	Type
S0	Output pulse numbers register address	32-bit, BIN
S1	Output pulse frequency register address	32-bit, BIN
S2	Pulse acceleration/deceleration time register address	32-bit, BIN
D0	Pulse output terminal	Bit
D1	Pulse output direction	Bit

#### 3. Suitable soft component

word	Operand	System								Constant	Module	
		D*	FD	ID*	CD*	DX	DY	DM*	DS*	K/H	ID	QD
	S0	•	•	•	•	•	•	•	•	•		
	S1	•	•	•	•	•	•	•	•	•		
	S2	•	•	•	•	•	•	•	•	•		

  

Bit	Operand	System						
		X	Y	M*	S*	T*	C*	Dnm
	D0		•					
	D1		•					

\*Note: D means D, HD. TD means TD, HTD. CD means CD, HCD, HSCD, HSD. DM means DM, DHM.

DS means DS, DHS. M means M, HM, SM. S means S, HS. T means T, HT. C means C, HC.

### Function and action

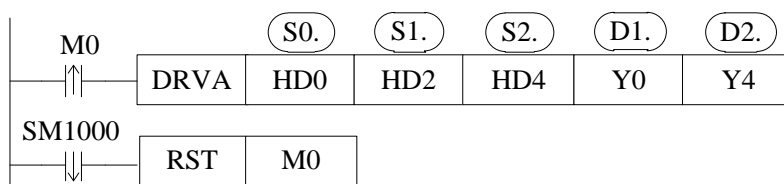

- Pulse frequency output range: 1Hz ~100KHz (note: PLC can output 100~200KHz pulse, but we cannot ensure all the servo drive can work fine, please connect 500Ω resistor between output terminal and 24V power supply)
- Pulse numbers: K-2,147,483,648 ~ K2,147,483,647; negative value means output pulse in reverse direction.
- Absolute driving mode: move from the origin point (the distance between origin position and target position), origin point is the reference point.

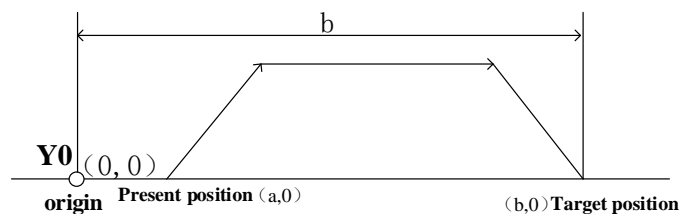

- DRVA does not use the system parameter block configuration mode, if the public and the first set of parameters (except the deceleration parameters) are configured, they will be effective for DRVA.
- The pulse number is accumulated in register HSD0 (double word).
- The pulse frequency can be real-time changed when the instruction is executing, the new frequency will be effective at once. (PLC firmware v3.4.5 and up can support)

- The acceleration and deceleration time is same for DRVA instruction.
- The direction of absolute positioning instruction depends on whether the target position is larger than present position, if the target position is larger than present position (the target position is on the right of present position on the axis), the pulse is sent in forward direction and the accumulative pulse register (HSD0, HSD4...) value increases; if the target position is smaller than present position (the target position is on the left of present position on the axis), the pulse is sent in reverse direction and the accumulative pulse register (HSD0, HSD4...) value decreases, if the target position is equal to present position (the target position overlaps present position on the axis), it will not send pulse.
- When S0 parameters are same to pulse accumulated register HSD0, SM1000 will not act, no falling edge.

**Example 1**

X axis present coordinates is (100, 0), it needs to move to target position (3000, 0) with the speed 1000Hz, start frequency and end frequency is 0Hz, pulse output terminal is Y0, direction terminal is Y4. As HSD0(dword) present value is 100, the target position is 3000, target position is larger than present position, send forward direction pulse, the execution diagram of DRVA is shown as below:

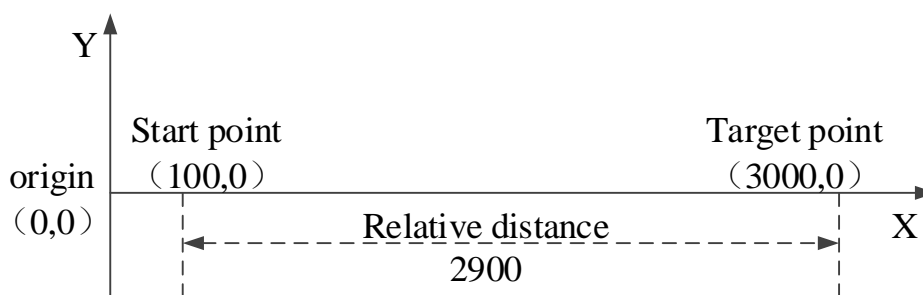
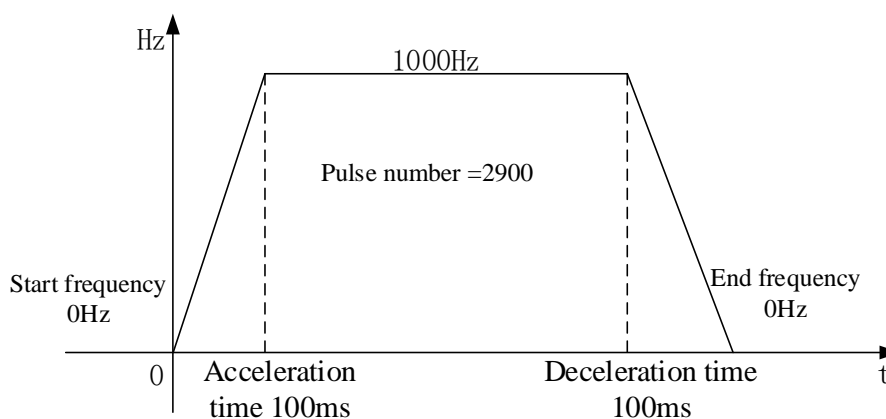
**Pulse coordinate diagram****Pulse curve diagram**

➤ **Program:**

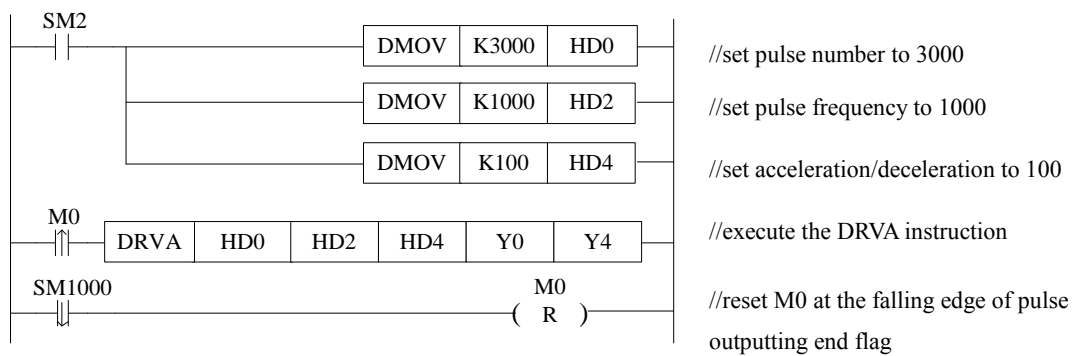

**Example 2**

X axis present coordinates is (3000, 0), it needs to move to target position (100, 0) with the speed 1000Hz, start frequency and end frequency is 0Hz, pulse output terminal is Y0, direction terminal is Y4. As HSD0(dword) present value is 3000, the target position is 100, present position is 3000, the relative distance is  $100-3000=-2900$ , the execution diagram of DRVA is shown as below:

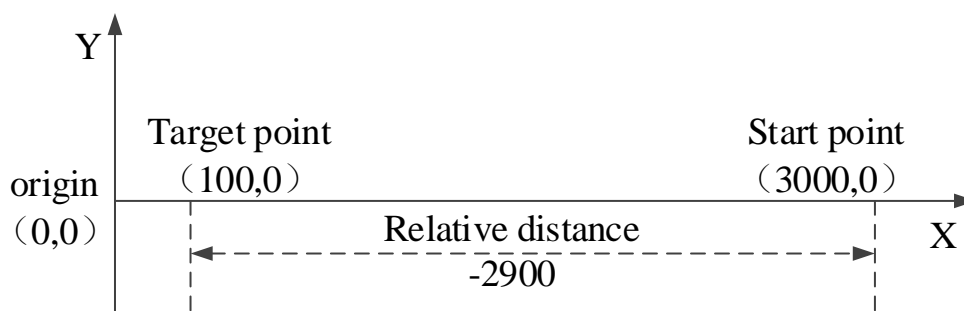

**Pulse coordinate diagram**

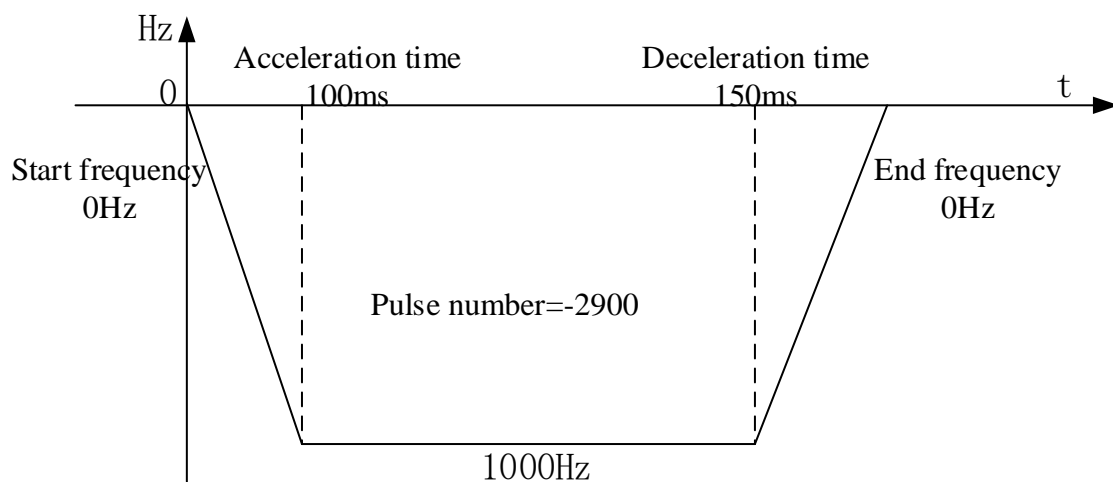

**Pulse curve diagram**

➤ Program:

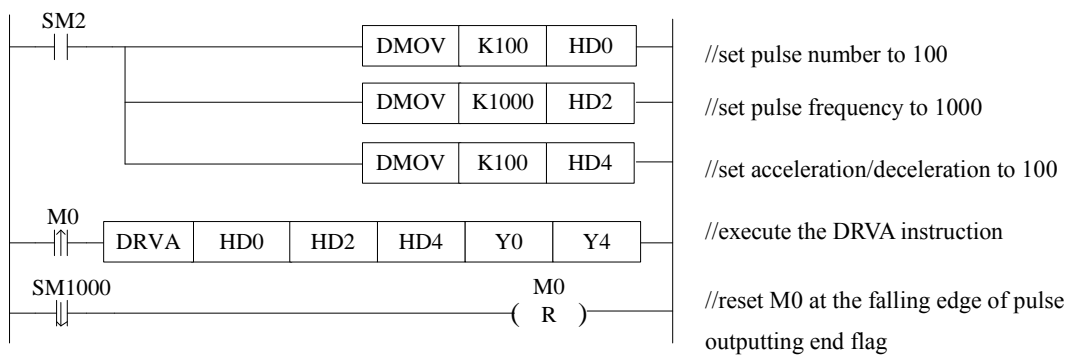

**Example 3**

There is a ball screw workbench, the motor has 5000 pulses per circle, X axis present coordinate is (100mm, 0), start speed and end speed is 0mm/s, it needs to reach the target position (220mm, 0) with the speed 15000 (30mm/s), the pulse output terminal is Y0, pulse direction terminal is Y4, as the accumulated pulse number register HSD0 present value is 50000 (100mm), the relative distance from target position 110000 (220mm) to present position 50000 (100mm) is 60000=110000-50000. The execution diagram of DRVA is shown as below:

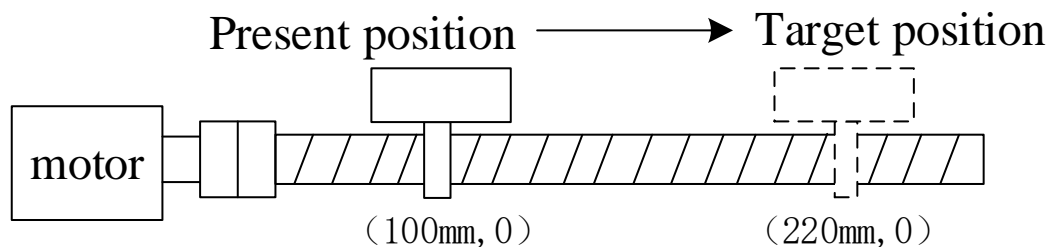

Ball screw pitch: 10mm

Ball screw diagram

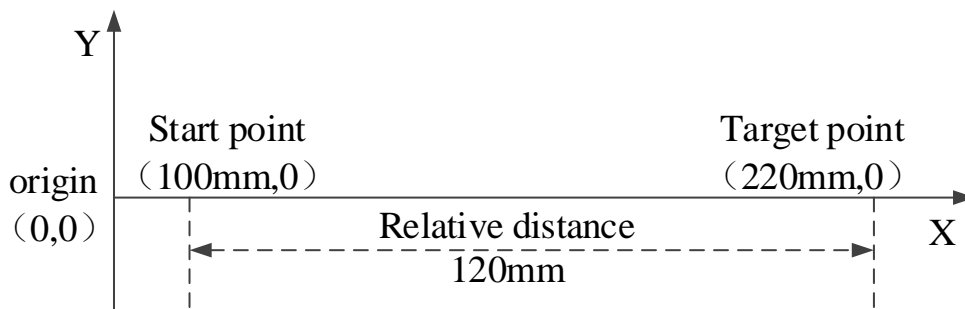

Pulse coordinate diagram

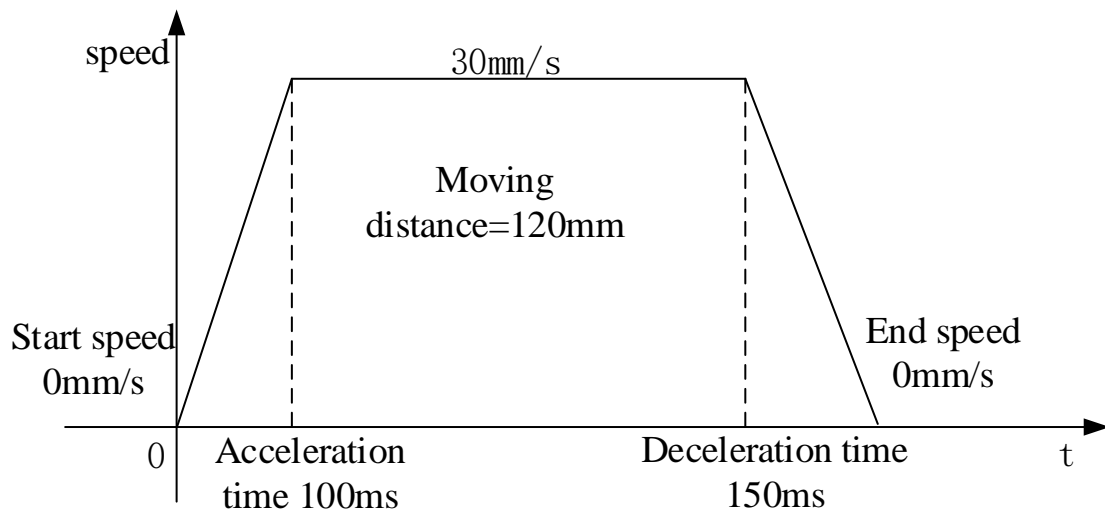

pulse curve diagram

## ➤ Program:

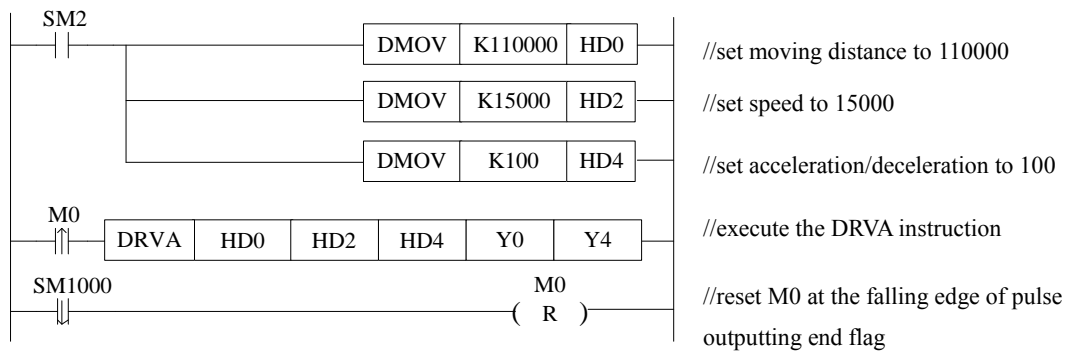
**Example 4**

There is a ball screw workbench, the motor has 5000 pulses per circle, X axis present coordinate is (220mm, 0), start speed and end speed is 0mm/s, it needs to reach the target position (100mm, 0) with the speed 15000 (30mm/s), the pulse output terminal is Y0, pulse direction terminal is Y4, as the accumulated pulse number register HSD0 present value is 110000 (220mm), the relative distance from target position 50000 (100mm) to present position 110000 (220mm) is  $-60000=50000-110000$ . The execution diagram of DRVA is shown as below:

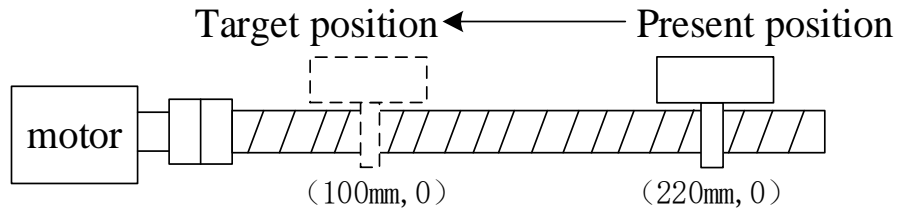

Ball screw pitch: 10mm

Ball screw diagram

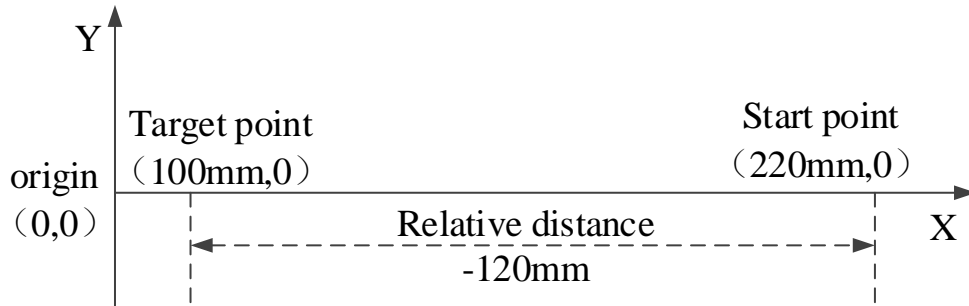

Pulse coordinate diagram

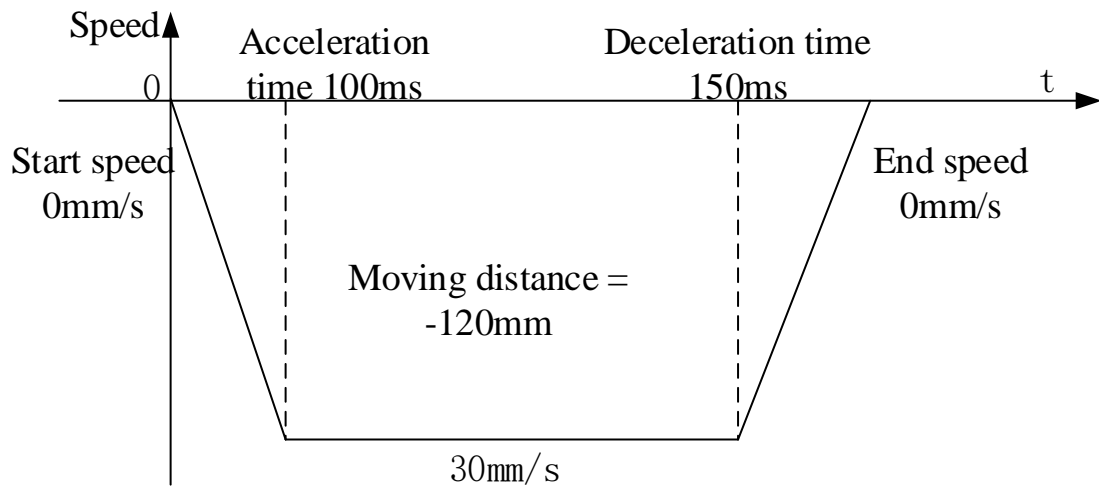

Pulse curve diagram



➤ **Program:**

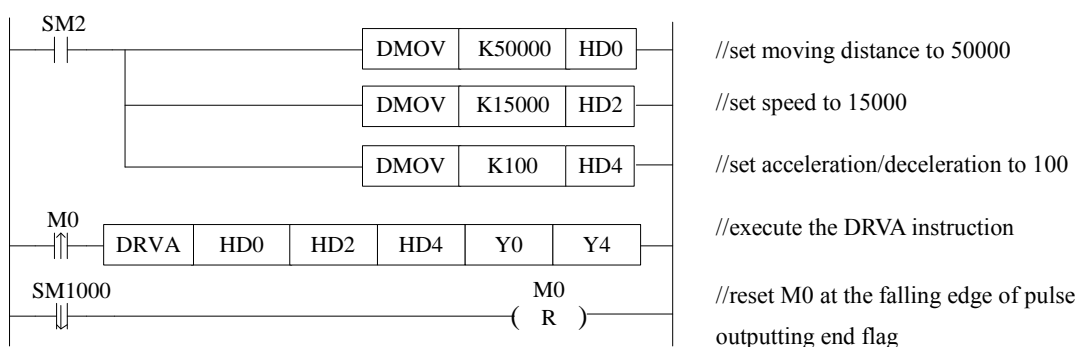

## 1-2-6. Mechanical origin return[ZRN]

### 1. Instruction overview

Mechanical origin return instruction. (note: ZRN cannot support the function of soft limit and origin auxiliary signal)

Mechanical origin return [ZRN]			
16-bit instruction		32-bit instruction	ZRN
Execution condition	Rising/falling edge of the coil	Suitable model	XD, XL (except XD1, XL1)
Hardware	-	Software	-

### 2. Operand

Operand	Function	Type
S	System parameter block address	32-bit, double words
D	Pulse output terminal	Bit

### 3. Suitable soft component

word	Operand	System								Constant	Module	
		D*	FD	TD*	CD*	DX	DY	DM*	DS*	K/H	ID	QD
	S	•	•	•	•	•	•	•	•			
Bit	Operand	System										
		X	Y	M*	S*	T*	C*	Dnm				
	D		•									

\*Note: D means D, HD. TD means TD, HTD. CD means CD, HCD, HSCD, HSD. DM means DM, DHM.

DS means DS, DHS. M means M, HM, SM. S means S, HS. T means T, HT. C means C, HC.

**Function and action**

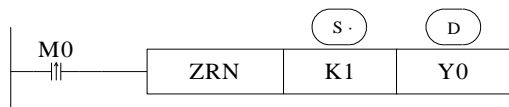

- The system parameter block please refer to chapter 1-2-1-3.
- ZRN instruction panel configuration is shown as below:

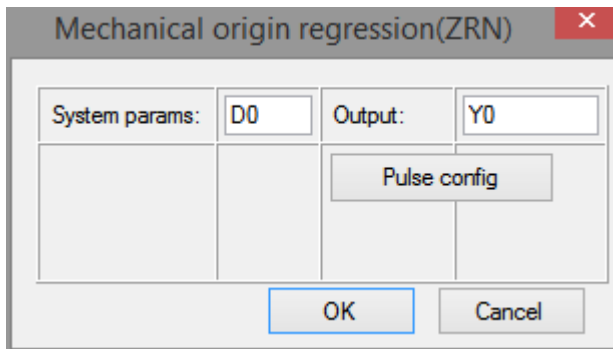

- Mechanical origin returning diagram:

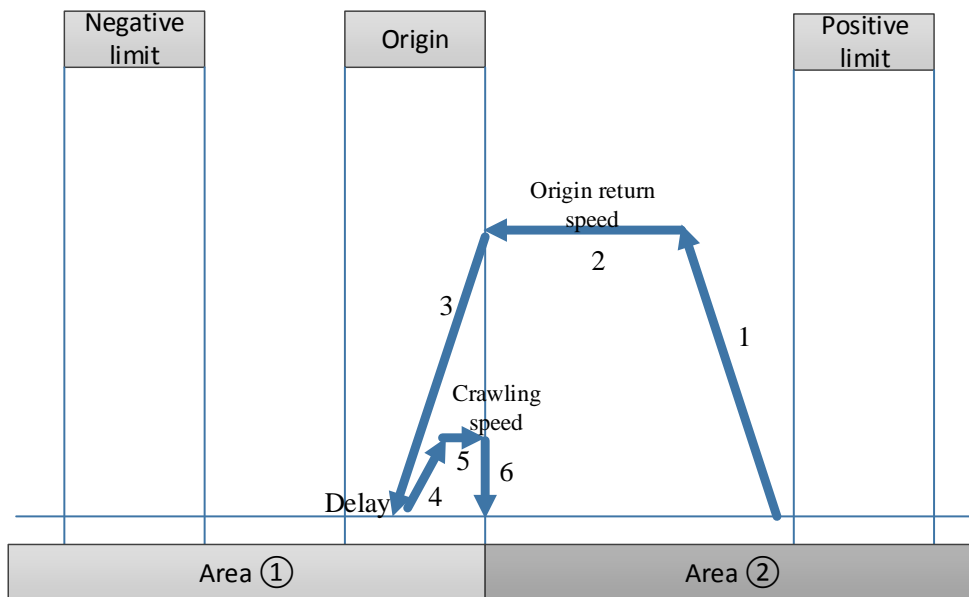

**Note:**

If setting the servo Z phase, it starts to count the Z phase signal at the moment of leaving the origin signal with crawling speed (5), it stops mechanical origin return instruction after Z phase signal counting reached, please see below diagram:

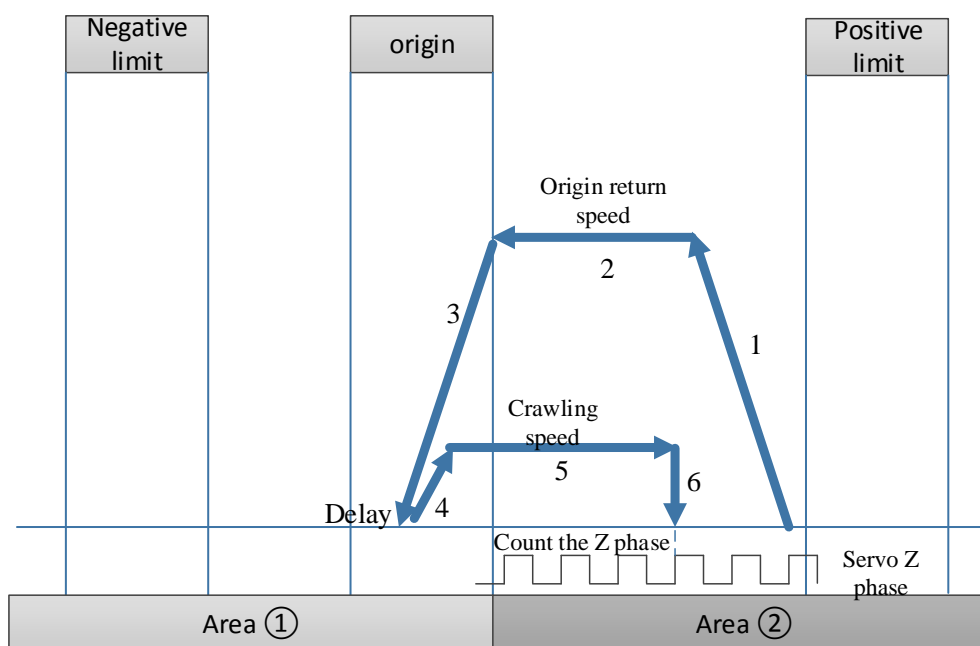

- Mechanical origin return movement

(1) when the origin return starts, it accelerates as the acceleration slope, after reaching the origin return speed, it will move towards origin return direction with this speed.

(2) when it meets the rising edge of origin signal, it will decelerate with deceleration slope until stop (frequency = 0).

(3) delay (direction delay time in SFD), then accelerate with acceleration slope until reaching the crawling speed, it stops origin return action at the moment of leaving the origin signal falling edge (if setting the Z phase pulse, it starts counting the Z phase after leaving the origin signal falling edge, it will stop origin return action after the counting value reached).

(4) if setting the origin return clear signal CLR, it will output CLR signal and delay (the CLR signal delay time in SFD, CLR signal can be used to clear the servo motor error counter), finally, copy the mechanical origin position to present position and the origin return action finished.

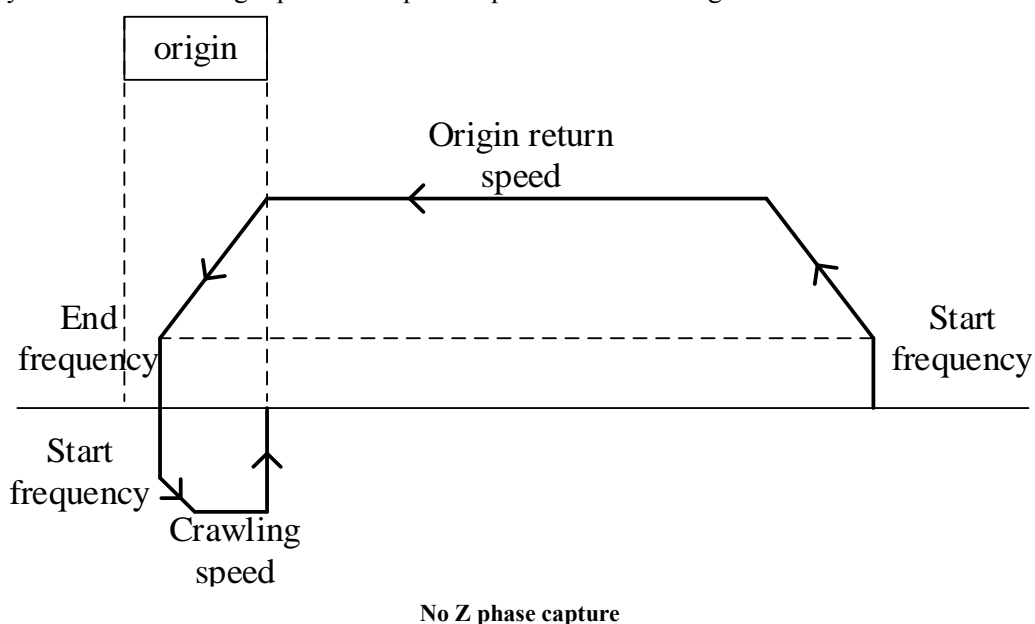

No Z phase capture

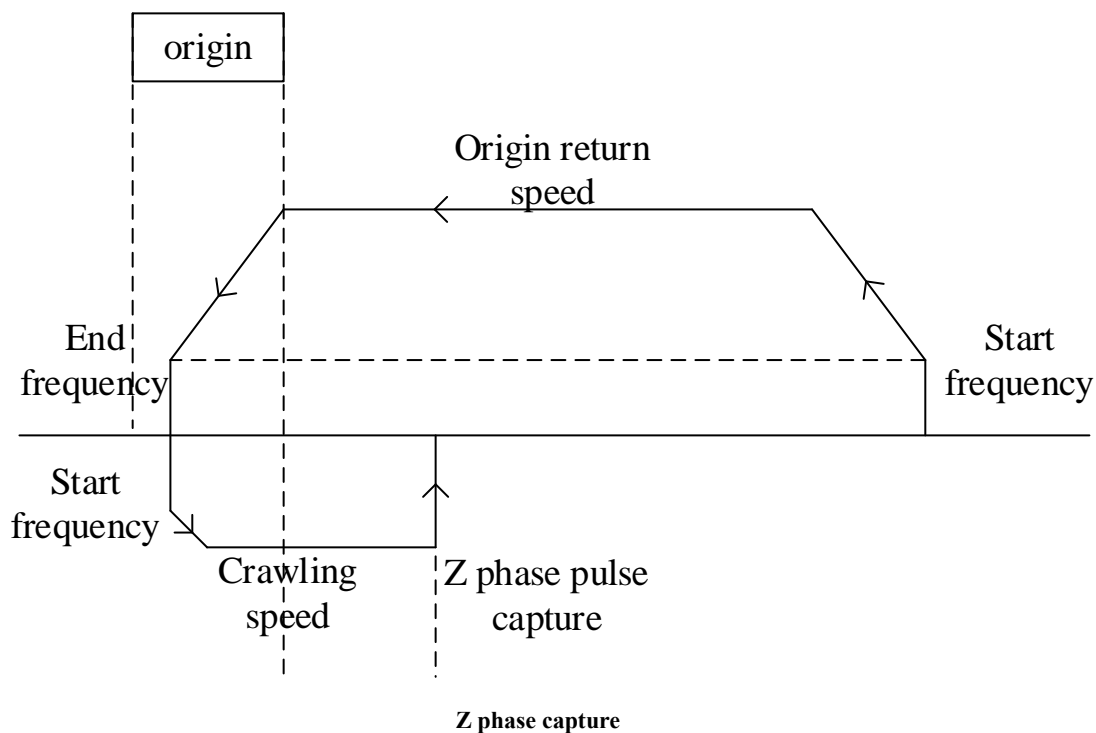

**Mechanical origin input terminal positive/negative logic (normally on/off) setting:**

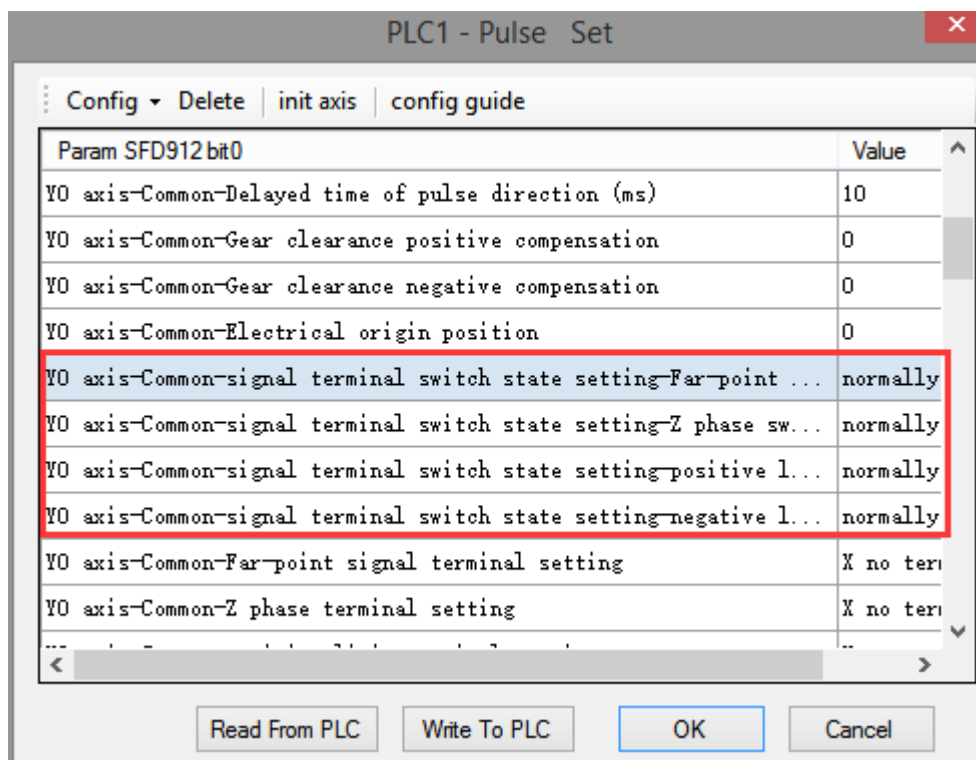

**Mechanical origin return setting notes:**

The origin signal terminal can select all input points on the PLC; However, if the selected input

point is the external interrupt terminal on the PLC, the process of returning to the mechanical origin will be processed according to the interrupt, so as to further improve the accuracy of returning to the mechanical origin (it will not be affected if Z phase is used to return to the origin). The selected input point is the external interrupt terminal not from the PLC, which will be affected by the scanning cycle of PLC in the process of mechanical origin (it will not be affected if Z phase is used to return to the origin). For detailed external interrupt terminals, please refer to appendix 4 of this manual.

**Pulse output terminal configuration table:**

PLC mode	Pulse channel	Pulse output terminal	Max output frequency	Output mode	Output mode
XD2-16T/RT XD2-24T/RT XD2-32T/RT XD2-48T/RT XD2-60T/RT	2	Y0, Y1	0~100KHz	Open collector mode	Pulse + direction
XD3-16T/RT XD3-24T/RT XD3-32T/RT XD3-48T/RT XD3-60T/RT	2	Y0, Y1	0~100KHz	Open collector mode	Pulse + direction
XD5-16T/RT XD5-24T/RT XD5-32T/RT XD5-48T/RT XD5-60T/RT	2	Y0, Y1	0~100KHz	Open collector mode	Pulse + direction
XD5-24T4 XD5-32T4	4	Y0, Y1, Y2, Y3	0~100KHz	Open collector mode	Pulse + direction
XD5-48T6 XD5-60T6	6	Y0, Y1, Y2, Y3, Y4, Y5	0~100KHz	Open collector mode	Pulse + direction
XDM-24T4 XDM-32T4 XDM-60T4	4	Y0, Y1, Y2, Y3	0~100KHz	Open collector mode	Pulse + direction
XDM-60T10	10	Y0, Y1, Y2, Y3, Y4, Y5, Y6, Y7, Y10, Y11	0~100KHz	Open collector mode	Pulse + direction
XD5E-30T4	4	Y0, Y1, Y2, Y3	0~100KHz	Open collector mode	Pulse + direction
XL3-16	2	Y0, Y1	0~100KHz	Open collector mode	Pulse + direction

				mode	
--	--	--	--	------	--

**Note:**

- 1: PLC can output 100 KHz to 200 KHz pulses, but we cannot sure that all servo is running, please connect 500  $\Omega$  resistance between output and 24V power supply.
2. when using the positioning command, the pulse direction terminal can be freely defined in all the output transistor terminals except the pulse output terminal;
3. response time of pulse output transistor is 0.5us, response time of other output transistors is below 0.2ms.
4. when the pulse output terminal does not make the pulse output, it can also be used as the pulse direction terminal.

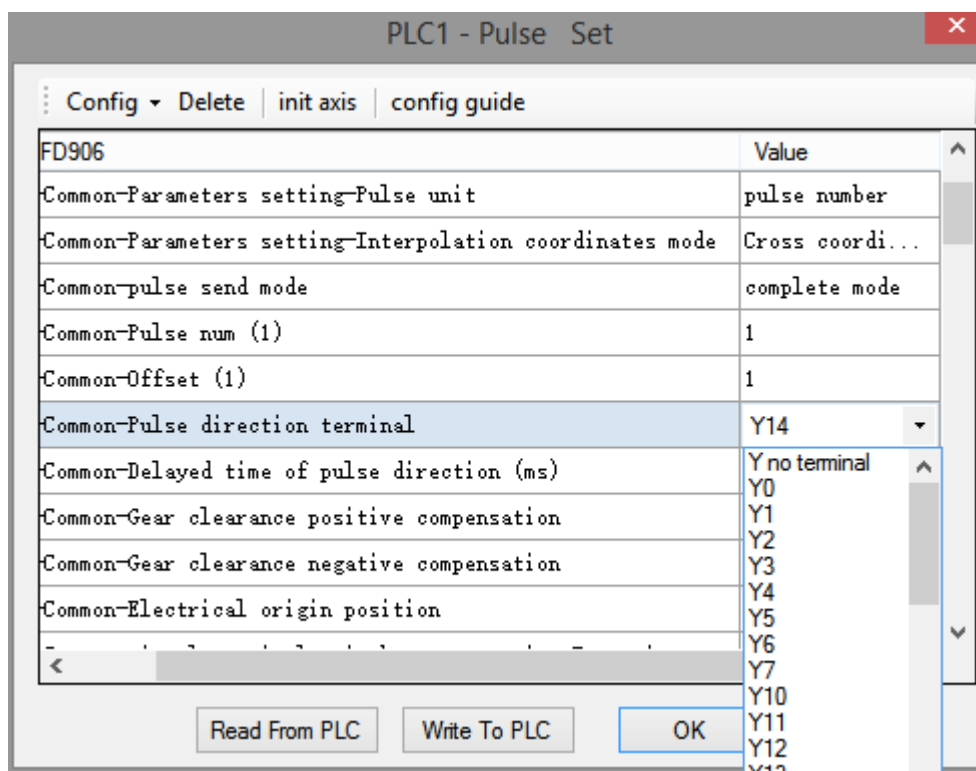
**Mechanical origin returning pulse direction signal:**

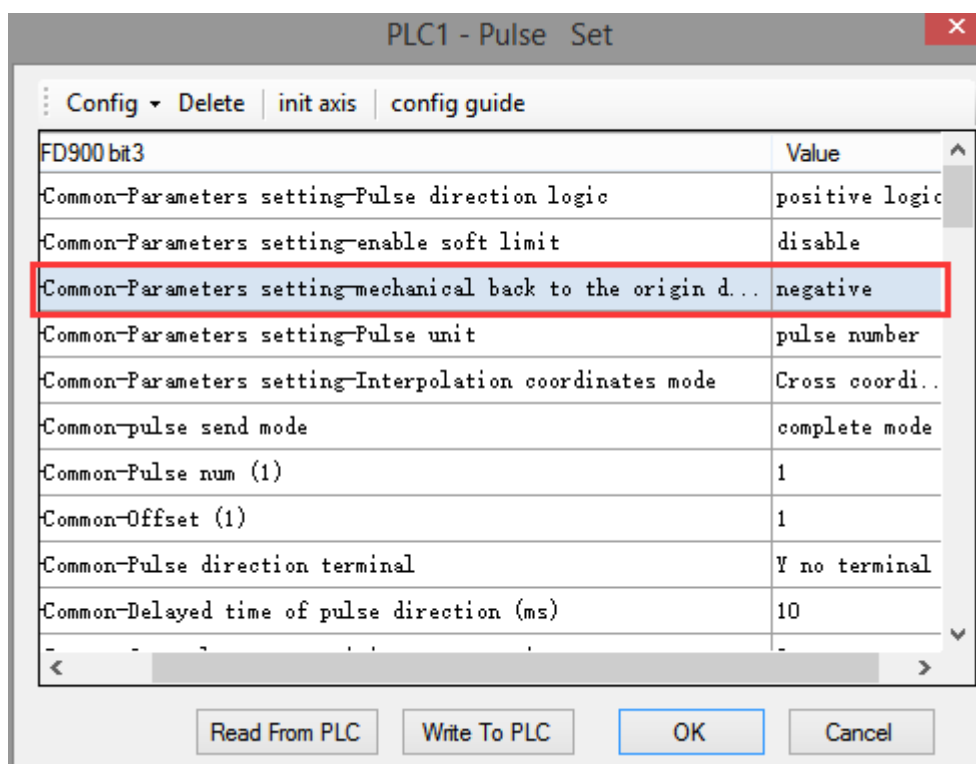
**Origin direction setting of mechanical origin returning:****Clear output signal CLR**

CLR signal setting, to output an output signal immediately after the end of returning to the mechanical origin, this signal can be sent to some other control equipment to achieve the purpose of rapid information transmission between each other. For example, after returning to the mechanical origin, the CLR signal is output to the servo driver immediately, so as to output clearance signal to clear the Error Counter of the servo motor. At last, copy the mechanical origin position value to the current position and the origin returning action is completed. The parameter configuration table is as follows:

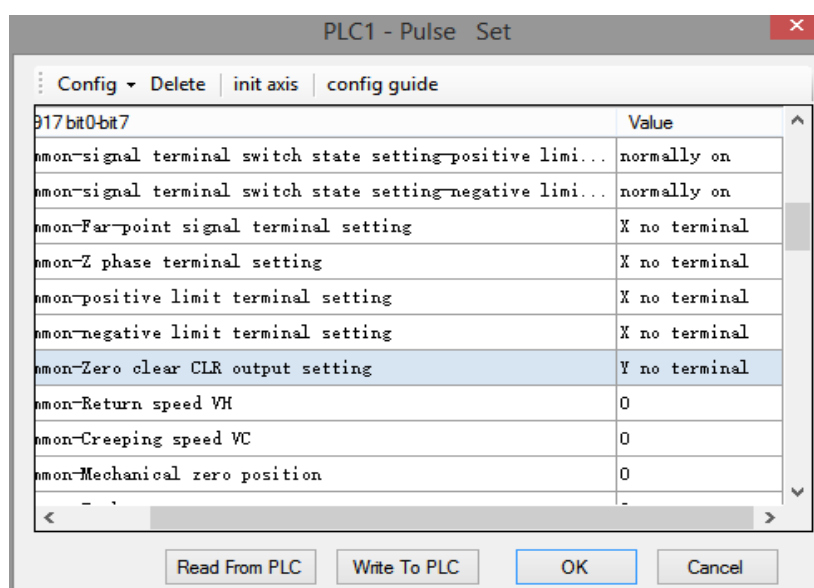

**CLR signal delay time:**

the pulse width of CLR signal outputting after mechanical origin returning, the unit is ms, range is 0~32767 (default 20ms). The parameter configuration table is as follows:

Parameter	Value
Common-Zero clear CLR output setting	Y no terminal
Common-Return speed VH	0
Common-Creeping speed VC	0
Common-Mechanical zero position	0
Common-Z phase num	0
Common-CLR signal delayed time (ms)	20
Common-grinding wheel radius(polar Interpolation)	0
Common-soft limit positive value	0
Common-soft limit negative value	0
Common-encoder pulse number/1 rotate(closed-loop pulse)	1

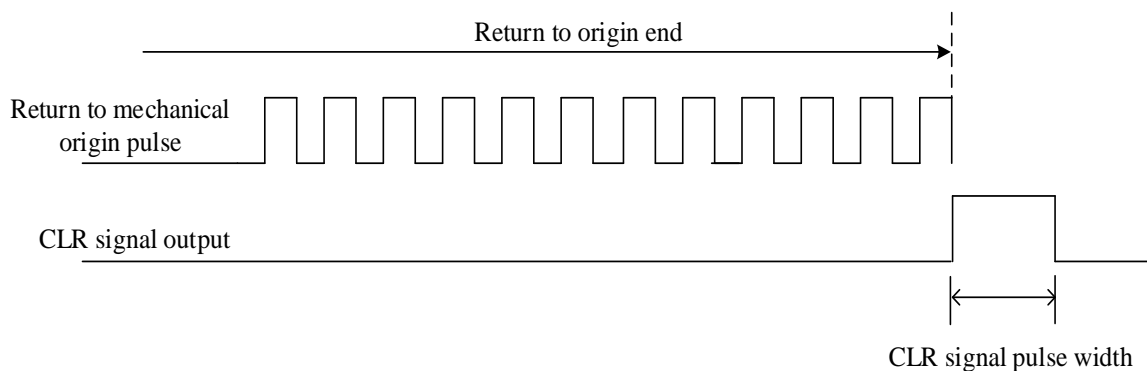

**CLR signal diagram**

**Note:**

1. The CLR signal output terminal should use the output terminal of the PLC.
2. Do not set the delay time of CLR signal too small, or the servo driver may be unable to receive the CLR signal.



## Motion analysis

### 1. The table is in area 2 when ZRN instruction started:

When the table is in area 2, it can be subdivided into three situations: the table is between the origin and the positive limit, the table is in the positive limit and the table is out of the positive limit.

- (1) The workbench is between origin and positive limit, return to origin in reverse direction

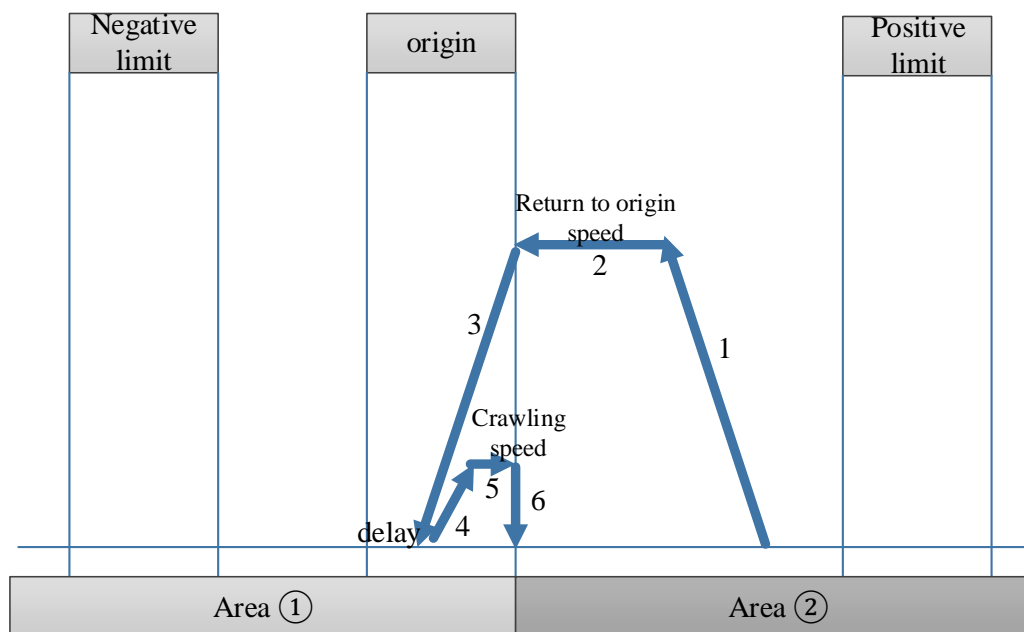

**Reverse return to origin**

#### **Actions:**

- (1) When the origin regression action starts, the acceleration is carried out first with the set acceleration slope, and the acceleration is accelerated to the origin regression speed, and then the regression speed of the origin is pushed back toward the mechanical origin direction.
- (2) When encountering the rising edge of the mechanical origin signal, slow down with the set deceleration slope until the deceleration to complete rest (frequency =0).
- (3) delay (direction delay time in SFD), and then accelerate as the set acceleration slope, move forward until reaching the crawling speed, when leaving the mechanical origin falling edge signal instantaneous stop zero movement (if it sets the Z phase pulse, it starts to count Z phase signal after leaving the origin signal falling edge, then immediately stop motion when the counting reached).
- (4) If "zeroing clear CLR signal" is set, it will output the clear signal immediately and delay (CLR signal delay time in SFD can be used to clear the Error Counter of the servo motor), At last, copy the mechanical origin position value to the current position and the zeroing action will be completed.

**Special case 1:**

When the acceleration of the just started ZRN instruction has reached the rising edge of the mechanical origin signal, the deceleration slope is used as the deceleration action until the deceleration is completely still (frequency =0); delay (direction delay time in SFD) and then run in reverse direction at low speed as acceleration slope until reach origin regression speed, when leaving the origin falling edge signal instantaneous stop zero movement (if it sets the Z phase pulse, it starts to count Z phase signal after leaving the origin signal falling edge, then immediately stop motion when the counting reached), if "zeroing clear CLR signal" is set, it will output the clear signal immediately and delay (CLR signal delay time in SFD can be used to clear the Error Counter of the servo motor), At last, copy the mechanical origin position value to the current position and the zeroing action will be completed.

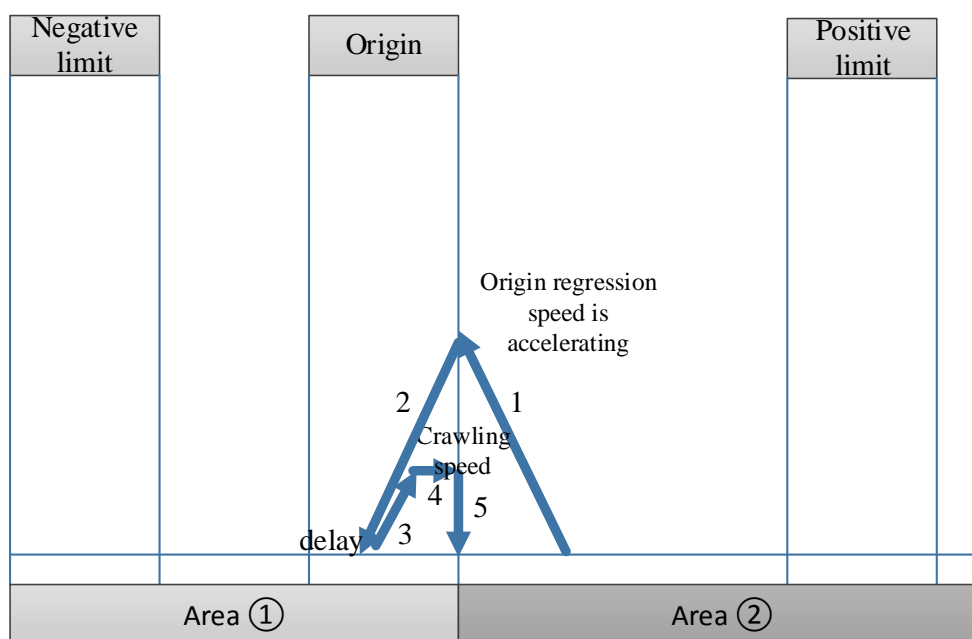
**Special case 2:**

When the acceleration of the just started ZRN instruction, it just accelerated to origin regression speed and reached the rising edge of the mechanical origin signal, the deceleration slope is used as the deceleration action until the deceleration is completely still (frequency =0); delay (direction delay time in SFD) and then run in reverse direction at low speed as acceleration slope until reach origin regression speed, when leaving the origin falling edge signal instantaneous stop zero movement (if it sets the Z phase pulse, it starts to count Z phase signal after leaving the origin signal falling edge, then immediately stop motion when the counting reached), if "zeroing clear CLR signal" is set, it will output the clear signal immediately and delay (CLR signal delay time in SFD can be used to clear the Error Counter of the servo motor), At last, copy the mechanical origin position value to the current position and the zeroing action will be completed.

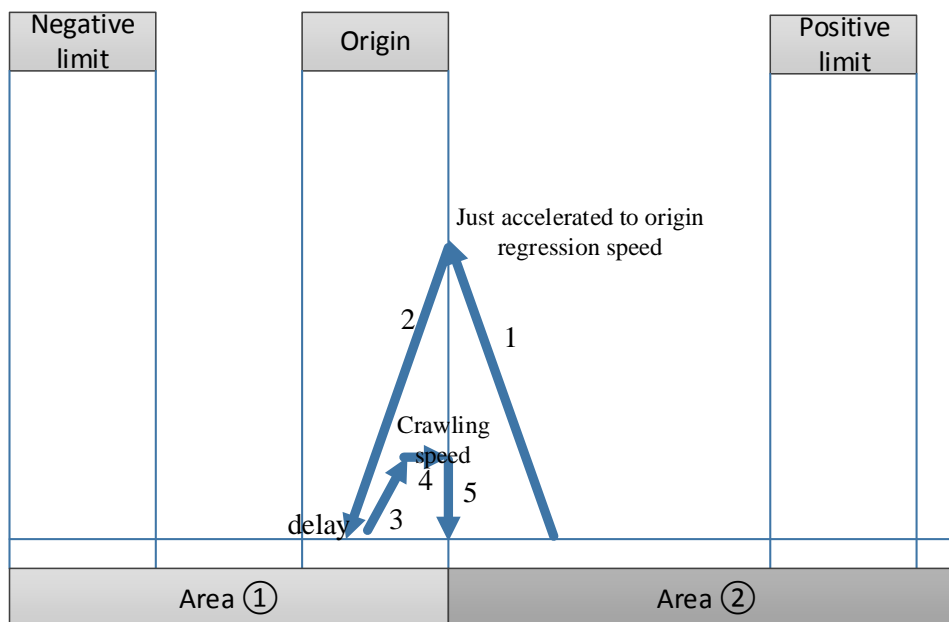
**Note:**

※1: In the above cases, as long as the rising edge of the origin signal is touched (the right edge of the origin), whether the acceleration has reached the speed of returning to the mechanical origin, is in the process of acceleration, or just accelerated to the speed of returning to the origin, the deceleration starts immediately according to the deceleration slope, until the speed is 0. Similarly, when the working table described below touches the rising edge of the negative limit (the right edge of the negative limit) and the rising edge of the positive limit (the left edge of the positive limit), please operate in the same way.

※2: when it sets the servo Z phase pulse, Z phase pulse returning to origin capture function is effective, it will stop the mechanical origin regression in Z phase mode.

※3: If the stopping position falls beyond the negative limit position, it may lead to collision. Please try your best to avoid such situation. This can be done by reducing the set deceleration slope or lengthening the length between the negative limit and the mechanical limit.

(2) workbench is between origin and positive limit, return to origin in forward direction

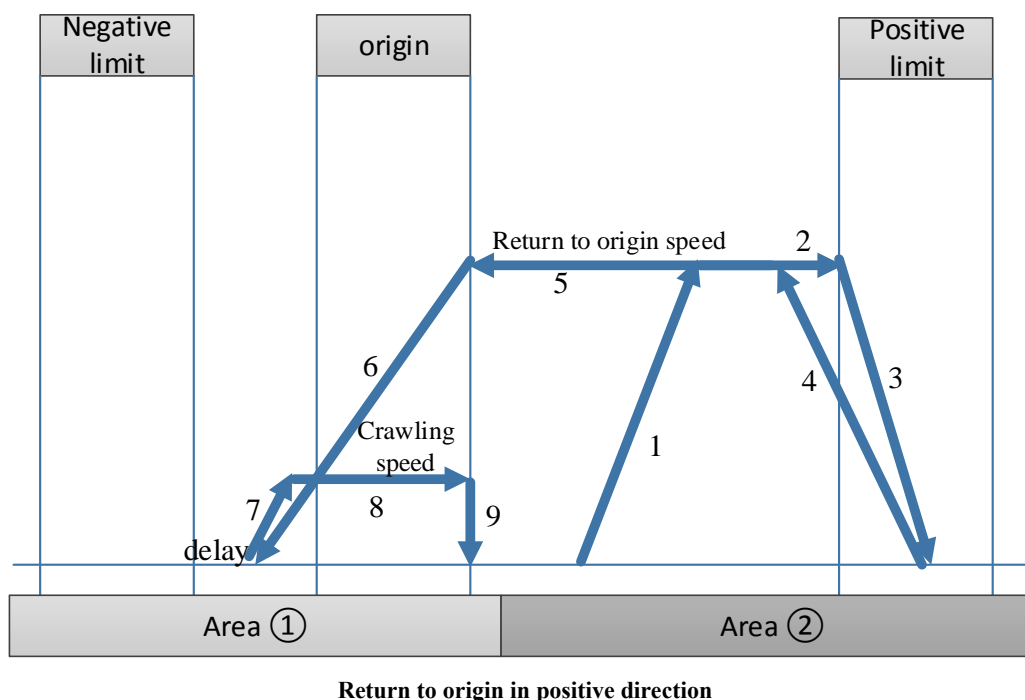
**Action:**

- (1) When the origin regression action starts, the acceleration is carried out first with the set acceleration slope, and the acceleration is accelerated to the origin regression speed, and then the regression speed of the origin moves toward the positive limit direction.
- (2) When encountering the rising edge of the positive limit signal, slow down with the set deceleration slope until the deceleration to complete rest (frequency =0).
- (3) Immediately reverse and start accelerating according to the specified acceleration slope until reaching origin regression speed, then the speed begins to recede towards the origin.
- (4) when encountering the rising edge of origin signal, slow down with the set deceleration slope until the deceleration to complete rest (frequency =0).
- (5) delay (direction delay time in SFD), and then accelerate as the set acceleration slope, move forward until reaching the crawling speed, when leaving the mechanical origin falling edge signal instantaneous stop zero movement (if it sets the Z phase pulse, it starts to count Z phase signal after leaving the origin signal falling edge, then immediately stop motion when the counting reached).
- (6) If "zeroing clear CLR signal" is set, it will output the clear signal immediately and delay (CLR signal delay time in SFD can be used to clear the Error Counter of the servo motor), At last, copy the mechanical origin position value to the current position and the zeroing action will be completed.

**Special case 1:**

For the just started ZRN instruction, when accelerating in the positive limit direction and already reached the rising edge of the positive limit signal, the deceleration slope is used as the deceleration action until the deceleration is completely still (frequency =0); then accelerate in reverse direction as acceleration slope until reach origin regression speed, then go back in origin direction, when meet the rising edge of origin signal, decelerate as deceleration slope until the

deceleration is completely still (frequency=0). Delay (direction delay time in SFD), low speed slow move in reverse direction with acceleration slope until reaching the origin regression speed, When leaving the origin falling edge signal instantaneous stop pulse outputting (if it sets the Z phase pulse, it starts to count Z phase signal after leaving the origin signal falling edge, then immediately stop zero return motion when the counting reached), if "zeroing clear CLR signal" is set, it will output the clear signal immediately and delay (CLR signal delay time in SFD can be used to clear the Error Counter of the servo motor), At last, copy the mechanical origin position value to the current position and the zeroing action will be completed.

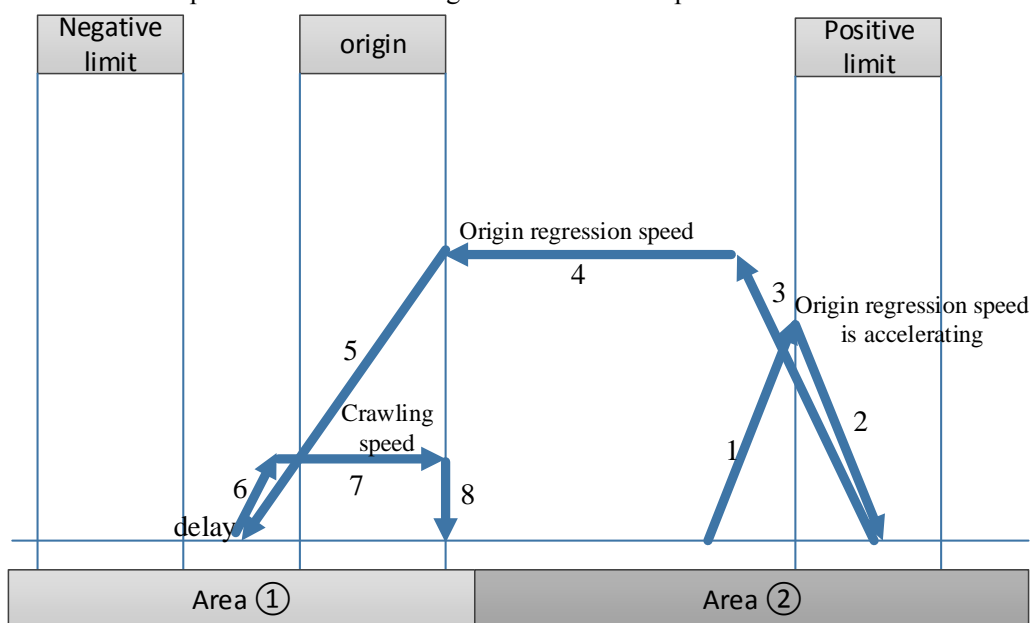

### Special case 2:

For the just started ZRN instruction, when accelerating to origin regression speed in the positive limit direction and just reached the rising edge of the positive limit signal, the deceleration slope is used as the deceleration action until the deceleration is completely still (frequency =0); then accelerate in reverse direction as acceleration slope until reach origin regression speed, then go back in origin direction, when meet the rising edge of origin signal, decelerate as deceleration slope until the deceleration is completely still (frequency=0). Delay (direction delay time in SFD), low speed slow move in reverse direction with acceleration slope until reaching the origin regression speed,

When leaving the origin falling edge signal instantaneous stop pulse outputting (if it sets the Z phase pulse, it starts to count Z phase signal after leaving the origin signal falling edge, then immediately stop zero return motion when the counting reached), if "zeroing clear CLR signal" is set, it will output the clear signal immediately and delay (CLR signal delay time in SFD can be used to clear the Error Counter of the servo motor), At last, copy the mechanical origin position value to the current position and the zeroing action will be completed.

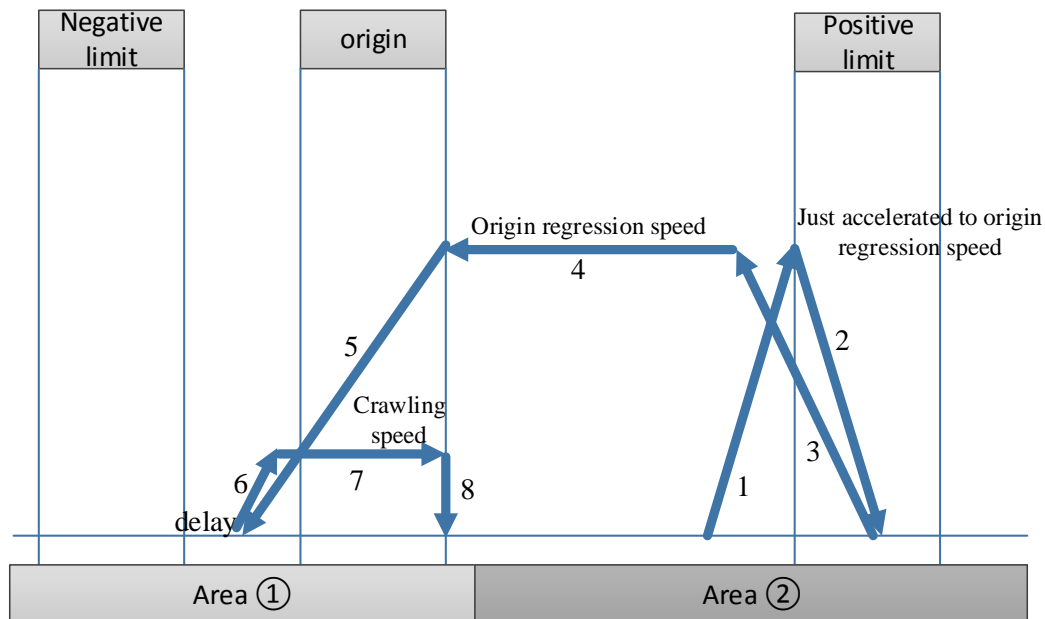

### Conclusion:

In the above cases, as long as the rising edge of the origin signal is touched (the right edge of the origin), whether the acceleration has reached the speed of returning to the mechanical origin, is in the process of acceleration, or just accelerated to the speed of returning to the origin, the deceleration starts immediately according to the deceleration slope, until the deceleration is 0. Similarly, when the working table described below touched the rising edge of the negative limit (the right edge of the negative limit) and the rising edge of the positive limit (the left edge of the positive limit), please operate them in the same way.

### Note:

※1: When the servo Z phase pulse is set, the Z phase pulse back to the origin capture function is effective, and the mechanical return to the origin will be stopped according to the Z phase mode.

※2: When the working table moves towards the positive limit with the speed of returning to the mechanical origin, it will start to decelerate according to the deceleration slope when it encounters the positive limit signal rising edge, and the deceleration stop position may fall on the positive limit or exceed the positive limit; Accidents that can occur when the positive limit is exceeded can be avoided by reducing the deceleration slope or widening the positive limit signal width. If the stopping position falls beyond the negative limit position, it may impact the machine. Please try your best to avoid such situation. This can be done by reducing the set deceleration slope or lengthening the length between the negative limit and the mechanical limit.

### (3) Execute origin returning when the workbench is in the positive limit

When the workbench is in the positive limit, return to the origin can only be performed by default in the reverse return to the origin mode, no matter whether the direction of return to the origin is set as forward return to the origin or reverse return to the origin, as shown in the figure below:

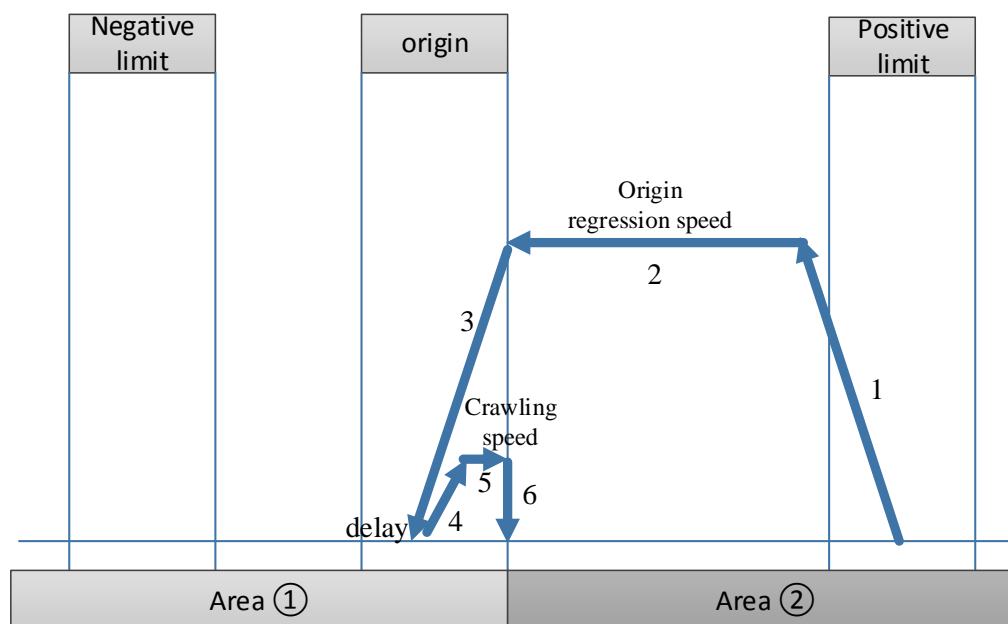

In the positive limit and execute origin returning

#### Action:

- (1) When the origin regression action starts, the acceleration is carried out first with the set acceleration slope, and accelerated to the origin regression speed, and then the regression speed of the origin is withdrawn back to the direction of the origin.
- (2) When encountering the rising edge of the origin signal, slow down with the deceleration slope until the deceleration is complete still (frequency = 0).
- (3) delay (the direction delay time in SFD), accelerate as the acceleration slope until reach the crawling speed, then move forward, stop zero returning action at the moment of leaving the falling edge of origin signal (if it set Z phase pulse, it starts counting the Z phase after leaving the falling edge of the origin signal, stop zero returning action at once when the count value reached)
- (4) if "zeroing clear CLR signal" is set, it will output the clear signal immediately and delay (CLR signal delay time in SFD can be used to clear the Error Counter of the servo motor), At last, copy the mechanical origin position value to the current position and the zeroing action will be completed.

#### Conclusion:

In the above cases, as long as the rising edge of the origin signal is touched (the right edge of the origin), whether the acceleration has reached the speed of returning to the mechanical origin, is in the process of acceleration, or just accelerated to the speed of returning to the origin, the deceleration starts immediately according to the deceleration slope, until the deceleration is 0. Similarly, when the working table described below touched the rising edge of the negative limit (the right edge of the negative limit) and the rising edge of the positive limit (the left edge of the positive limit), please operate them in the same way.

#### Note:

※1: When the servo Z phase pulse is set, the Z phase pulse back to the origin capture function is effective, and the mechanical return to the origin will be stopped according to the Z phase mode.

※2: If the stopping position falls beyond the negative limit position, it may impact the machine. Please try your best to avoid such situation. This can be done by reducing the set deceleration slope or lengthening the length between the negative limit and the mechanical limit.

(4) execute the origin returning when workbench exceeds the positive limit

When the working table exceeds the positive limit, in order to prevent the occurrence of machine impact caused by positive return-to-origin, do not execute the return-to-origin. Please move the working table back to the negative( or positive) limit or between the positive limit and the negative limit manually, and then execute the mechanical return-to-origin instruction!

The limit switch width of the negative limit and positive limit can also be widened to avoid the occurrence of breaking off the positive limit and negative limit when the pulse deceleration stops.

(5) When the table moves back toward the origin with the speed of mechanical return, it will start to slow down according to the set deceleration slope when it touches the rising edge of the mechanical origin. Due to the setting of different speed of mechanical return to the origin and deceleration slope, the final stop position of the table is relatively long, which shall be executed according to the following situations:

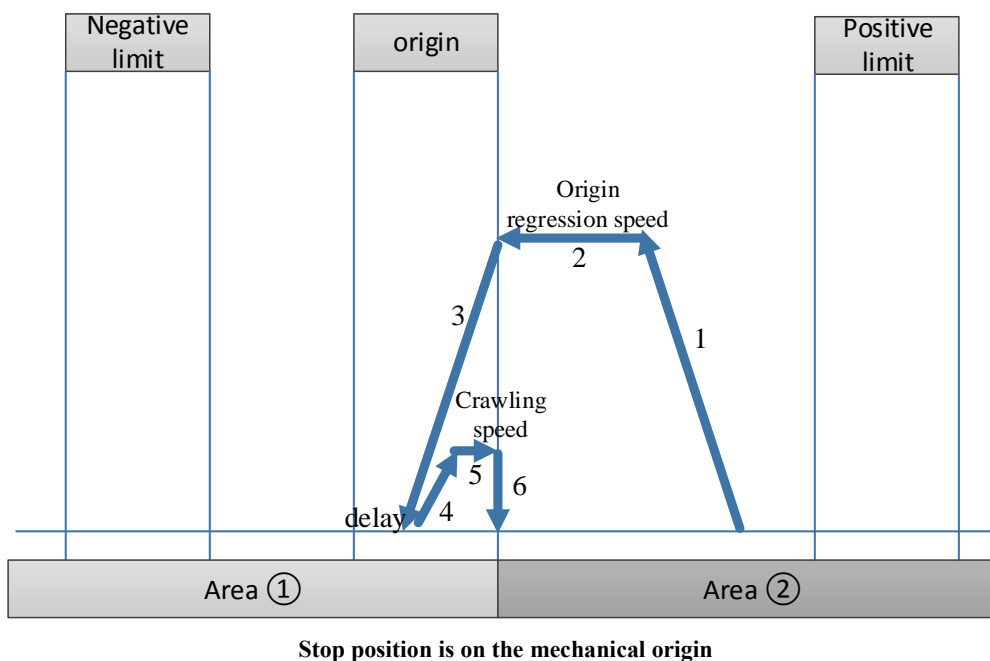



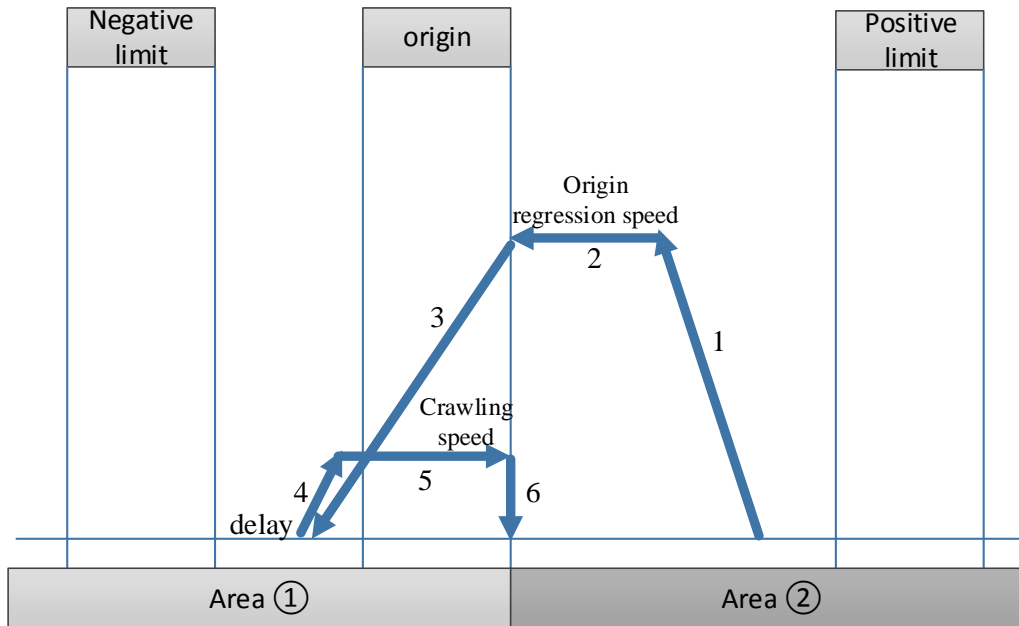

Stop position is between mechanical origin and negative limit

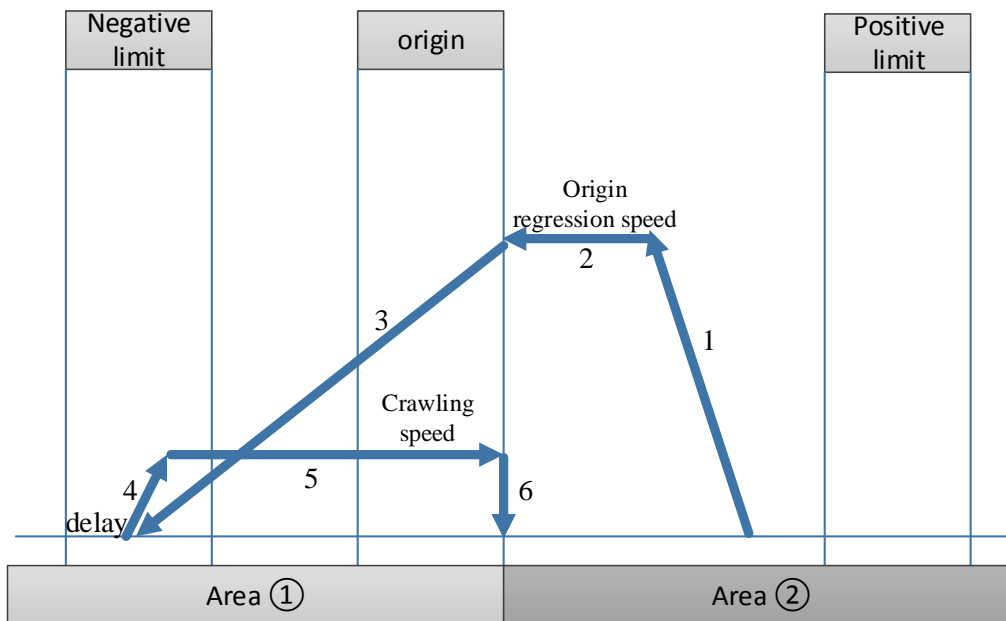

Stop position is on the negative limit

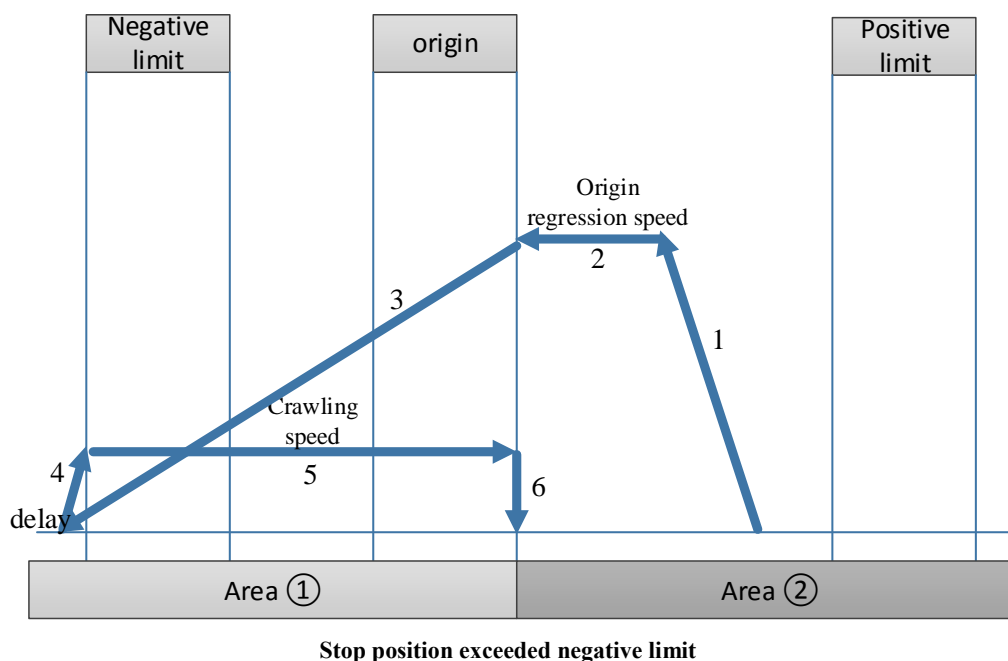
**Note:**

※1: When the servo Z phase pulse is set, the Z phase pulse back to the origin capture function is effective, and the mechanical return to the origin will be stopped according to the Z phase mode.

※2: If the stopping position falls beyond the negative limit position, it may impact the machine. Please try your best to avoid such situation. This can be done by reducing the set deceleration slope or lengthening the length between the negative limit and the mechanical limit.

2. when the mechanical origin returning instruction ZRN starts, the working table is in area ①:  
When the work table is located in the region, it can be divided into four situations: the work table is between the origin and the negative limit, the work table is at the mechanical origin, the work table is at the negative limit and the work table is beyond the negative limit position.

(1) execute origin regression when the work table is between the origin and negative limit

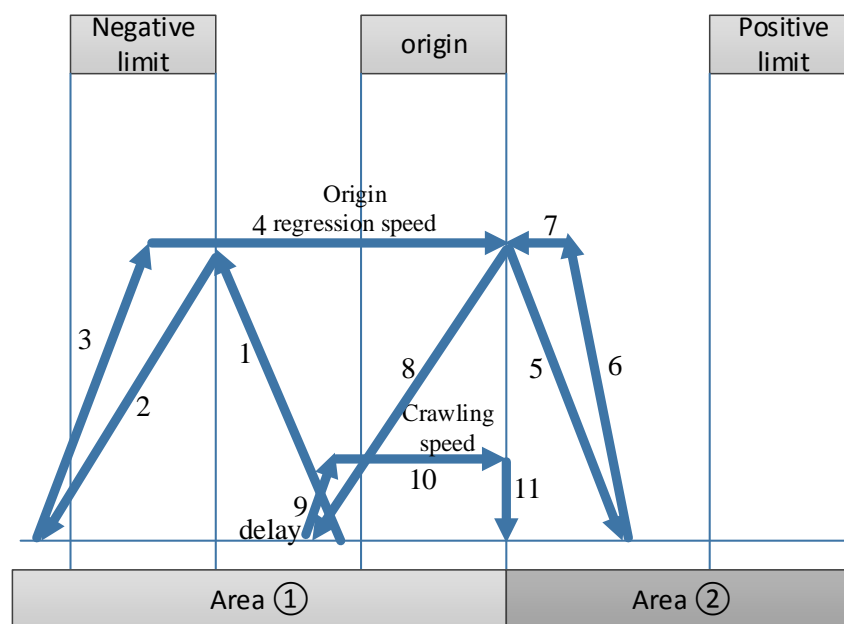

Execute origin regression in reverse direction

**Action:**

- (1) When the origin regression action starts, the acceleration is carried out first by the set acceleration slope, and then go back in the negative limit direction with the origin regression speed after accelerating to the origin regression speed.
- (2) when the work table encounters the rising edge of negative limit with the origin regression speed, it decelerates as the set deceleration slope until stop.
- (3) accelerate as the set acceleration slope until reach the origin regression speed, move forward in mechanical origin direction.
- (4) When the working table breaks away from the falling edge of the mechanical origin at the speed of mechanical return, it immediately begins to slow down according to the set deceleration slope, until the speed is 0.
- (5) The working table immediately accelerates to the speed of returning to the mechanical origin according to the set acceleration slope, and moves back toward the mechanical origin.
- (6) When encountering the rising edge of the origin signal, slow down with the deceleration slope until complete still (frequency =0).
- (7) delay (the direction delay time in SFD), accelerate as the acceleration slope until reach the crawling speed, then move forward, stop zero returning action at the moment of leaving the falling edge of origin signal (if it set Z phase pulse, it starts counting the Z phase after leaving the falling edge of the origin signal, stop zero returning action at once when the count value reached)
- (8) if "zeroing clear CLR signal" is set, it will output the clear signal immediately and delay (CLR signal delay time in SFD can be used to clear the Error Counter of the servo motor), At last, copy the mechanical origin position value to the current position and the zeroing action will be completed.

**Conclusion:**

In the above cases, as long as the rising edge of the origin signal is touched (the right edge of the origin), whether the acceleration has reached the speed of returning to the mechanical origin, is in

the process of acceleration, or just accelerated to the speed of returning to the origin, the deceleration starts immediately according to the deceleration slope, until the deceleration is 0. Similarly, when the working table described below touches the rising edge of the negative limit (the right edge of the negative limit) and the rising edge of the positive limit (the left edge of the positive limit), please operate them in the same way.

**Note:**

※1: When the servo Z phase pulse is set, the Z phase pulse back to the origin capture function is effective, and the mechanical return to the origin will be stopped according to the Z phase mode.

※2: If the stopping position falls beyond the negative limit position, it may impact the machine. Please try your best to avoid such situation. This can be done by reducing the set deceleration slope or lengthening the length between the negative limit and the mechanical limit.

(2) execute the origin regression when the work table is between origin and negative limit

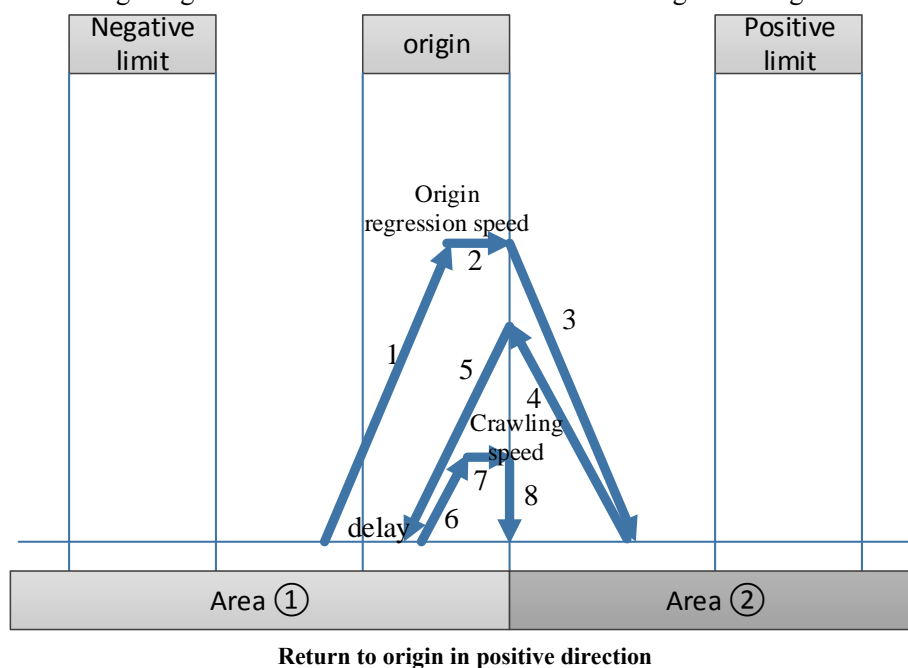

**Action:**

(1) When the origin regression action starts, the acceleration is carried out first with the set acceleration slope, and then accelerated to the origin regression speed and moved forward in mechanical origin direction.

(2) When the working table breaks away from the falling edge of the mechanical origin at the speed of mechanical return, it immediately begins to slow down according to the set deceleration slope, until the speed is 0.

(3) accelerate as the set acceleration slope until reach the mechanical origin regression speed, go back in mechanical origin direction.

(4) when the work table encounters the rising edge of origin signal, it decelerates as the set deceleration slope until stop (frequency is 0). Delay (the direction delay time in SFD), accelerate as the acceleration slope until reach the crawling speed, then move forward, stop zero returning action at the moment of leaving the falling edge of origin signal (if it set Z phase pulse, it starts counting the Z phase after leaving the falling edge of the origin signal, stop zero returning action

at once when the count value reached)

(5) if "zeroing clear CLR signal" is set, it will output the clear signal immediately and delay (CLR signal delay time in SFD can be used to clear the Error Counter of the servo motor), At last, copy the mechanical origin position value to the current position and the zeroing action will be completed.

### Conclusion:

In the above cases, as long as the rising edge of the origin signal is touched (the right edge of the origin), whether the acceleration has reached the speed of returning to the mechanical origin, is in the process of acceleration, or just accelerated to the speed of returning to the origin, the deceleration starts immediately according to the deceleration slope, until the deceleration is 0. Similarly, when the working table described below touches the rising edge of the negative limit (the right edge of the negative limit) and the rising edge of the positive limit (the left edge of the positive limit), please operate them in the same way.

### Note:

※1: When the servo Z phase pulse is set, the Z phase pulse back to the origin capture function is effective, and the mechanical return to the origin will be stopped according to the Z phase mode.

※2: When the origin returning action is started, the speed shall be accelerated by the set acceleration slope first. No matter whether the speed is accelerated to the speed of mechanical return to the origin, the work table will start to decelerate according to the set deceleration slope as soon as it touches the decline edge of mechanical origin signal.

(3) execute the origin returning when the work table is at the mechanical origin

When execute the reverse origin returning and the work table is at the mechanical origin, it will switch to positive origin returning inside, the details please refer to condition (4).

(4) execute the positive origin regression when the work table is at the mechanical origin

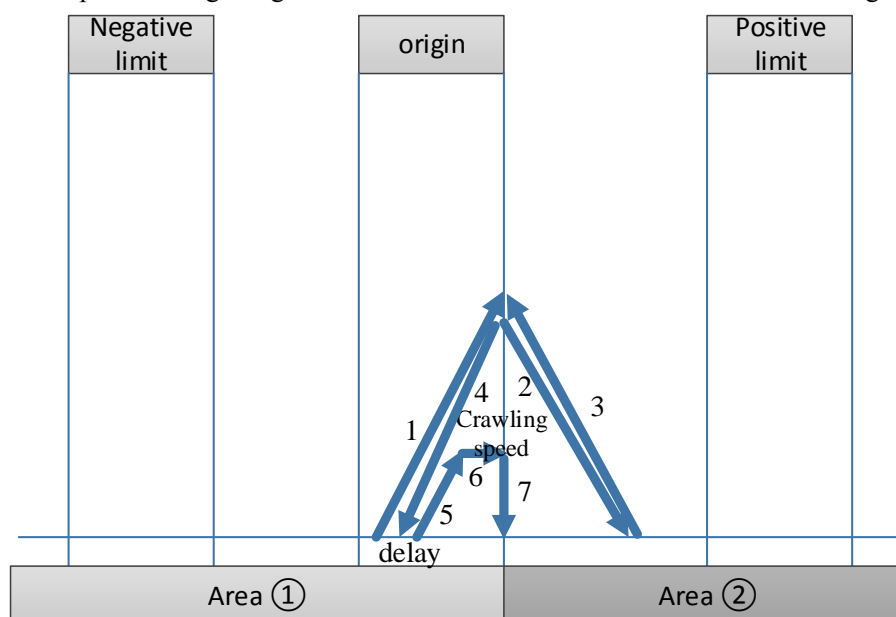

**Action:**

- (1) When the origin regression action starts, the acceleration is carried out first with the set acceleration slope, and then accelerated to the origin regression speed and moved forward in falling edge of mechanical origin direction.
- (2) Whether the table has been accelerated to the speed of the mechanical return to the origin according to the set acceleration slope, it will immediately begin to decelerate according to the set deceleration slope at the descent edge of the mechanical origin until the speed is 0.
- (3) The working table immediately starts to accelerate to the speed of returning to the mechanical origin according to the set acceleration slope, and moves back toward the mechanical origin.
- (4) Whether the table has been accelerated to the speed of the mechanical return to the origin according to the set acceleration slope, it will immediately begin to decelerate according to the set deceleration slope at the rising edge of the mechanical origin until the speed is 0. Delay (the direction delay time in SFD), accelerate as the acceleration slope until reach the crawling speed, then move forward, stop zero returning action at the moment of leaving the falling edge of origin signal (if it set Z phase pulse, it starts counting the Z phase after leaving the falling edge of the origin signal, stop zero returning action at once when the count value reached)
- (5) if "zeroing clear CLR signal" is set, it will output the clear signal immediately and delay (CLR signal delay time in SFD can be used to clear the Error Counter of the servo motor), At last, copy the mechanical origin position value to the current position and the zeroing action will be completed.

**Conclusion:**

In the above cases, as long as the rising edge of the origin signal is touched (the right edge of the origin), whether the acceleration has reached the speed of returning to the mechanical origin, is in the process of acceleration, or just accelerated to the speed of returning to the origin, the deceleration starts immediately according to the deceleration slope, until the deceleration is 0. Similarly, when the working table described below touches the rising edge of the negative limit (the right edge of the negative limit) and the rising edge of the positive limit (the left edge of the positive limit), please operate them in the same way.

**Note:**

- ※1: When the servo Z phase pulse is set, the Z phase pulse back to the origin capture function is effective, and the mechanical return to the origin will be stopped according to the Z phase mode.
- ※2: When the origin returning action is started, the speed shall be accelerated by the set acceleration slope first. No matter whether the speed is accelerated to the speed of mechanical return to the origin, the work table will start to decelerate according to the set deceleration slope as soon as it touches the decline edge of mechanical origin signal.

(5) execute the origin returning when the working table is at the negative limit

When the working table is at the negative limit, whatever the origin returning direction is set to positive or negative, it must execute as defaulted positive direction, shown as below:

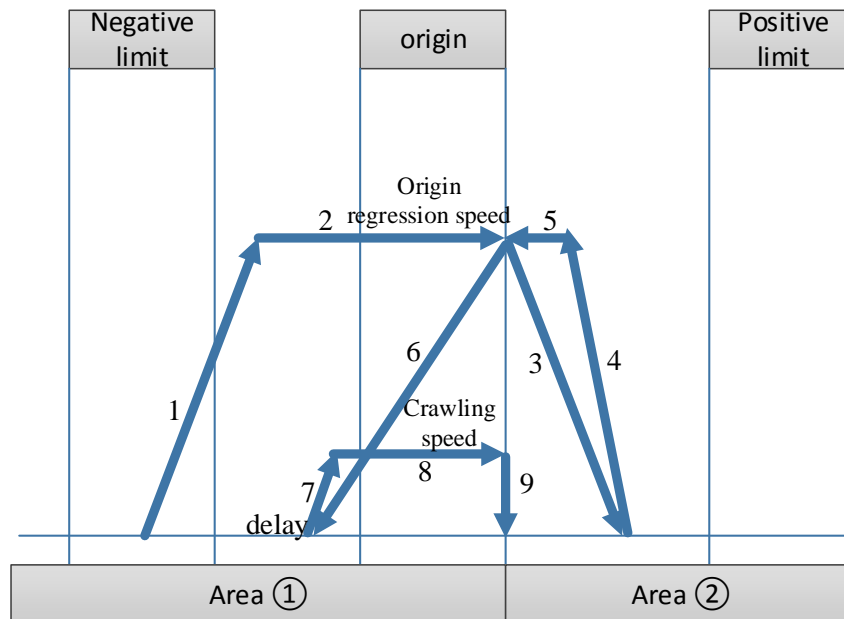

Execute origin regression at the negative limit

**Action:**

- (1) When the origin regression action starts, the acceleration is carried out first with the set acceleration slope, and then accelerated to the origin regression speed and moved forward in origin direction.
- (2) When encountering the descent edge of the origin signal, slow down by the deceleration slope until complete rest (frequency =0).
- (3) The table starts to accelerate immediately according to the set acceleration slope. Whether it has accelerated to the speed of mechanical return to the origin or not, as long as the table touches the rising edge of mechanical origin signal, it will immediately start to decelerate according to the set deceleration slope.
- (4) when the work table decelerated to stop, it started to delay (the direction delay time in SFD), then accelerated as the acceleration slope until reaching the crawling speed, then move forward, stop zero returning action at the moment of leaving the falling edge of origin signal (if it set Z phase pulse, it starts counting the Z phase after leaving the falling edge of the origin signal, stop zero returning action at once when the count value reached)
- (5) if "zeroing clear CLR signal" is set, it will output the clear signal immediately and delay (CLR signal delay time in SFD can be used to clear the Error Counter of the servo motor), At last, copy the mechanical origin position value to the current position and the zeroing action will be completed.

**Conclusion:**

In the above cases, as long as the rising edge of the origin signal is touched (the right edge of the origin), whether the acceleration has reached the speed of returning to the mechanical origin, is in the process of acceleration, or just accelerated to the speed of returning to the origin, the deceleration starts immediately according to the deceleration slope, until the deceleration is 0. Similarly, when the working table described below touches the rising edge of the negative limit (the right edge of the negative limit) and the rising edge of the positive limit (the left edge of the positive limit), please operate them in the same way.

Note: When the servo Z phase pulse is set, the Z phase pulse back to the origin capture function is effective, and the mechanical return to the origin will be stopped according to the Z phase mode.

(6) execute origin returning when the work table exceeded negative limit

When the working table exceeds the negative limit, in order to prevent the occurrence of machine impact caused by reverse-returning to the origin, please do not go back to the origin. Please move the working table back to the negative or positive limit or between them by manual and then carry out the execution of the mechanical returning to the origin instruction!

The limit switch width of the negative limit and positive limit can also be widened to avoid the occurrence of breaking off the positive limit and negative limit when the pulse deceleration stops.

3. When in consideration of equipment cost or mechanical structure, negative limit switches and mechanical origin switches may need to be used with a proximity switch or travel switch.

First, we set the mechanical origin and negative limit switch in system parameter block as the same input point. When executing the ZRN mechanical return instruction, this input point is used as the mechanical origin. This input point is used as a negative limit when using pulse output commands such as PLSR, PLSF, DRVI, and DRVA.

In view of the position of the work table returning to the mechanical origin, the following will be explained according to the following situations: the work table is between negative limit and positive limit, the work table is in negative limit, the work table is in positive limit, the work table exceeds positive limit position and the work table exceeds negative limit position.

(1) execute reverse origin returning when the work table is between negative limit and positive limit

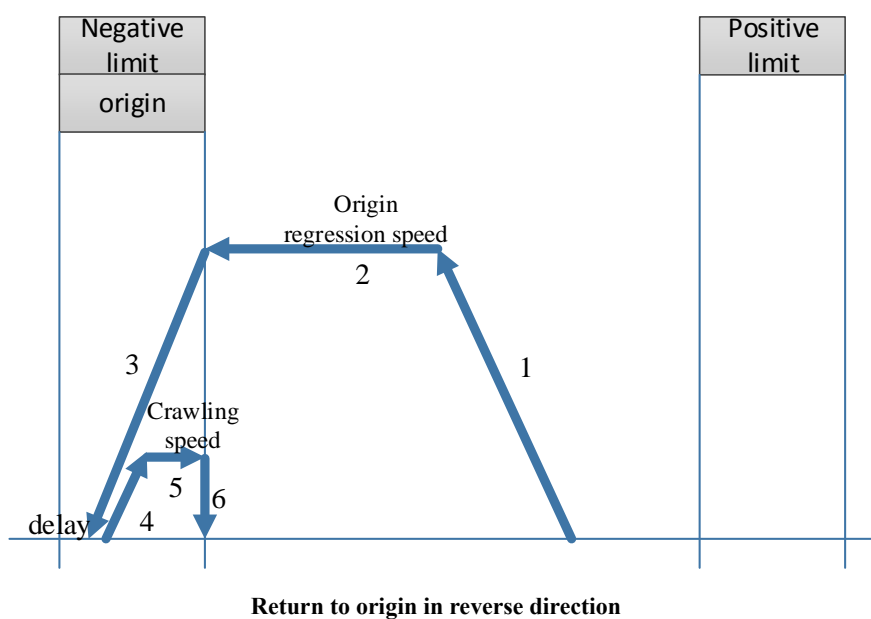

**Action:**

(1) When the origin regression action starts, the acceleration is carried out first with the set acceleration slope, and accelerated to the origin regression speed, and then went back toward the



mechanical origin direction.

(2) When encountering the rising edge of the origin signal, slow down by the deceleration slope until complete rest (frequency =0).

(3) delay (the direction delay time in SFD), then accelerated as the acceleration slope until reaching the crawling speed, then move forward, stop zero returning action at the moment of leaving the falling edge of origin signal (if it set Z phase pulse, it starts counting the Z phase after leaving the falling edge of the origin signal, stop zero returning action at once when the count value reached)

(4) if "zeroing clear CLR signal" is set, it will output the clear signal immediately and delay (CLR signal delay time in SFD can be used to clear the Error Counter of the servo motor), At last, copy the mechanical origin position value to the current position and the zeroing action will be completed.

### Special case 1:

When the acceleration of the just started ZRN instruction has reached the rising edge of the mechanical origin signal, the deceleration slope is used as the deceleration action until the deceleration is completely still (frequency =0); delay (the direction delay time in SFD), then reverse move at slow speed as acceleration slope until reach origin regression speed, when at the moment of leaving the origin signal falling edge, if "zeroing clear CLR signal" is set, it will output the clear signal immediately and delay (CLR signal delay time in SFD can be used to clear the Error Counter of the servo motor), At last, copy the mechanical origin position value to the current position and the zeroing action will be completed.

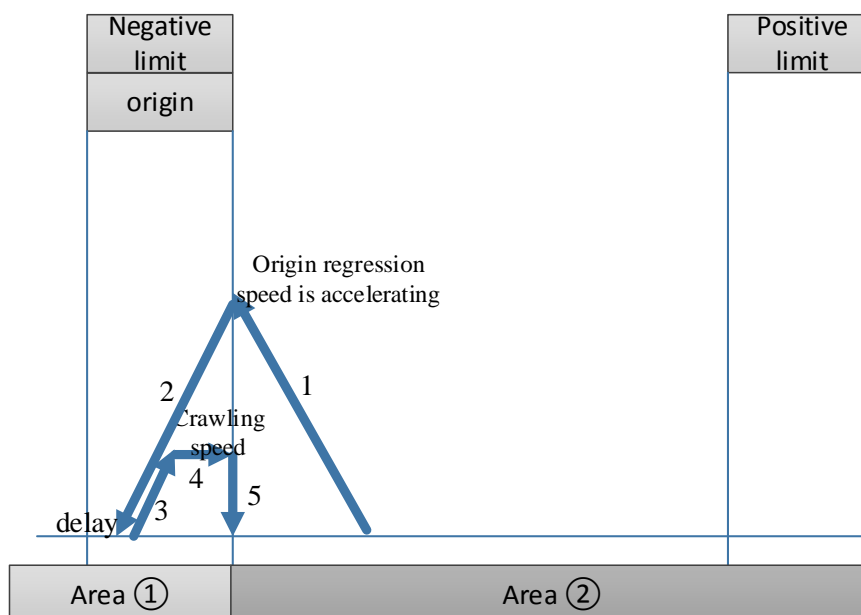

### Special case 2:

In the acceleration process of the just started ZRN instruction, when it just accelerated to origin regression speed, it reached the rising edge of the mechanical origin signal, the deceleration slope is used as the deceleration action until the deceleration is completely still (frequency =0); delay (the direction delay time in SFD), then reverse move at slow speed as acceleration slope until

reach origin regression speed, stop returning action at the moment of leaving the origin signal falling edge (if it set Z phase pulse, it starts counting the Z phase after leaving the falling edge of the origin signal, stop zero returning action at once when the count value reached), if "zeroing clear CLR signal" is set, it will output the clear signal immediately and delay (CLR signal delay time in SFD can be used to clear the Error Counter of the servo motor), At last, copy the mechanical origin position value to the current position and the zeroing action will be completed.

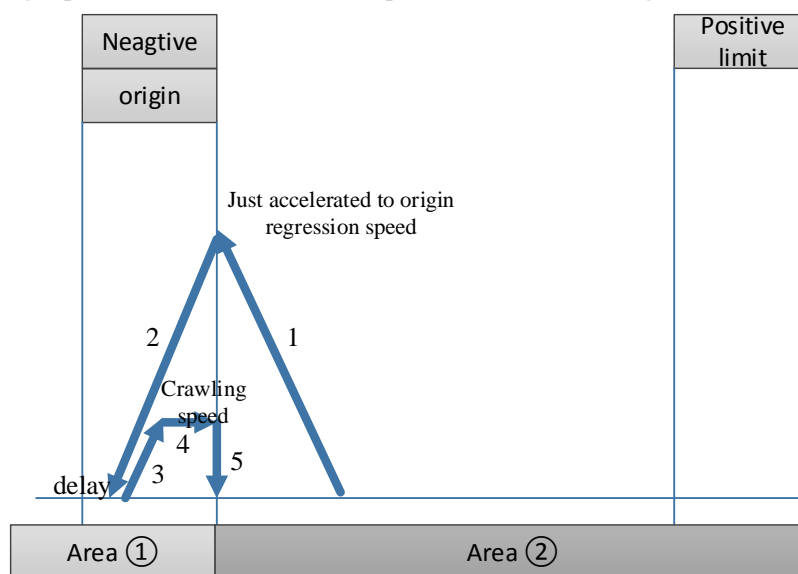

#### Conclusion:

In the above cases, as long as the rising edge of the origin signal is touched (the right edge of the origin), whether the acceleration has reached the speed of returning to the mechanical origin, is in the process of acceleration, or just accelerated to the speed of returning to the origin, the deceleration starts immediately according to the deceleration slope, until the deceleration is 0. Similarly, when the working table described below touches the rising edge of the negative limit (the right edge of the negative limit) and the rising edge of the positive limit (the left edge of the positive limit), please operate them in the same way.

#### Note:

- ※1: When the servo Z phase pulse is set, the Z phase pulse back to the origin capture function is effective, and the mechanical return to the origin will be stopped according to the Z phase mode.
- ※2: If the stopping position falls beyond the negative limit position, it may lead to machine impact. Please try your best to avoid such situation. This can be done by reducing the stated deceleration slope or lengthening the length between the negative limit and the mechanical limit.

- (2) execute origin returning in forward direction when the work table is between negative limit and positive limit

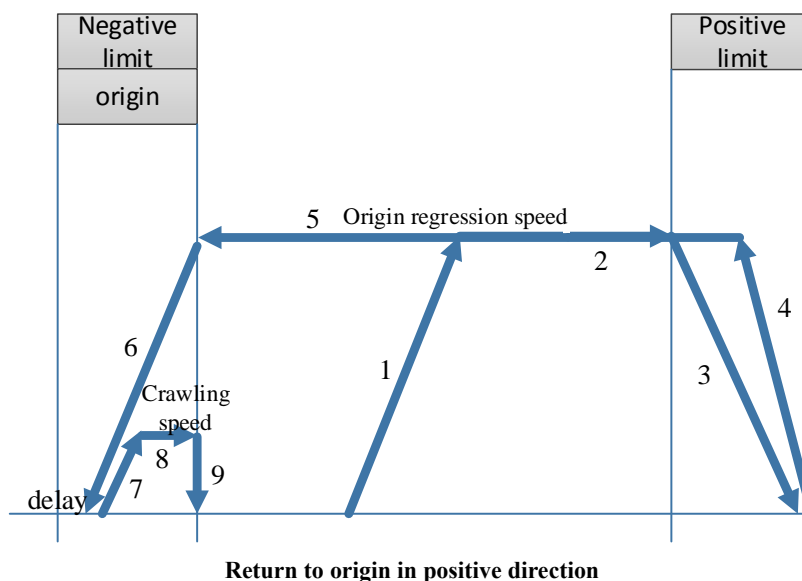

**Action:**

- (1) When the origin regression action starts, the acceleration is carried out first with the set acceleration slope, and accelerated to the origin regression speed, and then went forward toward the positive direction of positive limit.
- (2) When encountering the rising edge of the origin signal, slow down by the deceleration slope until complete rest (frequency =0).
- (3) Immediately reverse and start accelerating according to the specified acceleration slope until reaching the origin regression speed and begins to recede towards the origin.
- (4) When encountering the rising edge of the origin signal, slow down by the deceleration slope until complete rest (frequency =0).
- (5) delay (the direction delay time in SFD), then accelerated as the acceleration slope until reaching the crawling speed, then move forward, stop zero returning action at the moment of leaving the falling edge of origin signal (if it set Z phase pulse, it starts counting the Z phase after leaving the falling edge of the origin signal, stop zero returning action at once when the count value reached)
- (6) if "zeroing clear CLR signal" is set, it will output the clear signal immediately and delay (CLR signal delay time in SFD can be used to clear the Error Counter of the servo motor), At last, copy the mechanical origin position value to the current position and the zeroing action will be completed.

**Special case 1:**

For the just started ZRN instruction, when it has already reached the rising edge of the positive limit signal in the process of accelerating towards positive limit, the deceleration slope is used as the deceleration action until the deceleration is completely still (frequency =0); immediately reverse and start accelerating according to the set acceleration slope until reaching the origin regression speed, then start go back, when encountering the rising edge of the origin signal, slow down by the deceleration slope until complete stop (frequency =0); delay(direction delay time in SFD), then reverse move at slow speed as acceleration slope until reach origin regression speed, at

the moment of leaving the origin signal falling edge, stop pulse outputting at once(if it set Z phase pulse, it starts counting the Z phase after leaving the falling edge of the origin signal, stop zero returning action at once when the count value reached). If "zeroing clear CLR signal" is set, it will output the clear signal immediately and delay (CLR signal delay time in SFD can be used to clear the Error Counter of the servo motor), At last, copy the mechanical origin position value to the current position and the zeroing action will be completed.

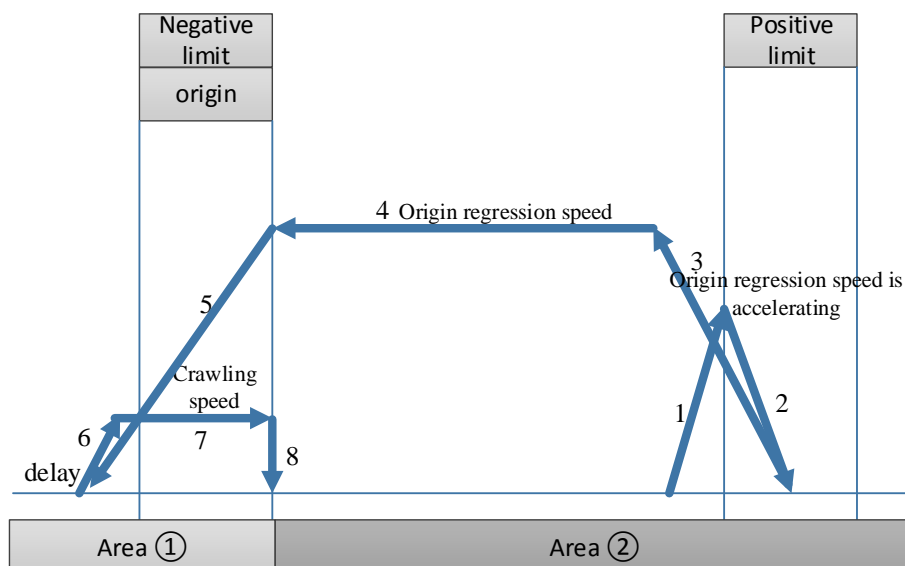

### Special case 2:

For the just started ZRN instruction, when it just reached the rising edge of the positive limit signal in the process of accelerating towards positive limit and just accelerated to origin returning speed, the deceleration slope is used as the deceleration action until the deceleration is completely still (frequency =0); immediately reverse and start accelerating according to the set acceleration slope until reaching the origin regression speed, then start go back, when encountering the rising edge of the origin signal, slow down by the deceleration slope until complete stop (frequency =0); delay(direction delay time in SFD), then reverse move at slow speed as acceleration slope until reach origin regression speed, at the moment of leaving the origin signal falling edge, stop pulse outputting at once(if it set Z phase pulse, it starts counting the Z phase after leaving the falling edge of the origin signal, stop zero returning action at once when the count value reached). If "zeroing clear CLR signal" is set, it will output the clear signal immediately and delay (CLR signal delay time in SFD can be used to clear the Error Counter of the servo motor), At last, copy the mechanical origin position value to the current position and the zeroing action will be completed.

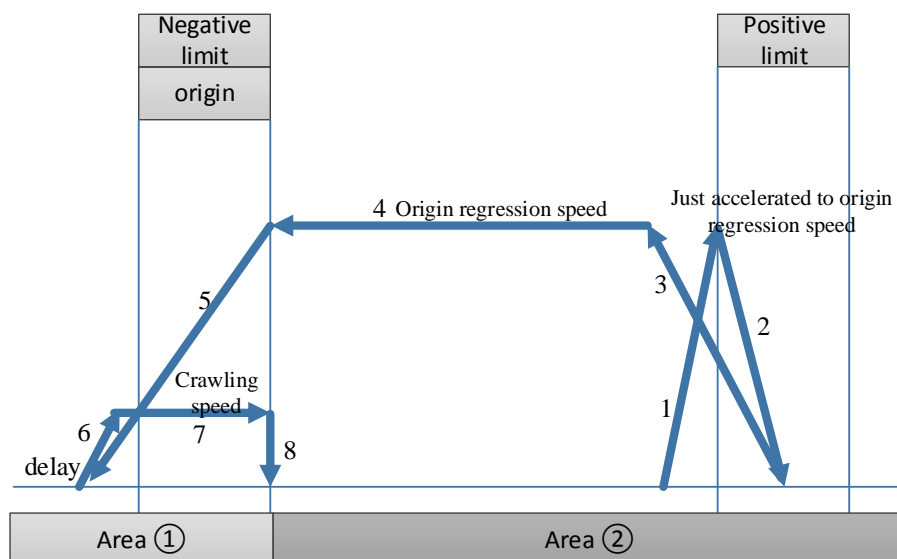

### Conclusion:

In the above cases, as long as the rising edge of the origin signal is touched (the right edge of the origin), whether the acceleration has reached the speed of returning to the mechanical origin, is in the process of acceleration, or just accelerated to the speed of returning to the origin, the deceleration starts immediately according to the deceleration slope, until the deceleration is 0. Similarly, when the working table described below touches the rising edge of the negative limit (the right edge of the negative limit) and the rising edge of the positive limit (the left edge of the positive limit), please operate them in the same way.

### Note:

- ※1: When the servo Z phase pulse is set, the Z phase pulse back to the origin capture function is effective, and the mechanical return to the origin will be stopped according to the Z phase mode.
- ※2: When the working table moves towards the positive limit with the speed of returning to the mechanical origin, it will start to decelerate according to the deceleration slope when it encounters the positive limit signal rising edge, and the deceleration stop position may fall on the positive limit or exceed the positive limit; Accidents that can occur when the positive limit is exceeded, which can be avoided by reducing the deceleration slope or widening the positive limit signal width.
- ※3: If the stopping position falls beyond the negative limit position, it may lead to machine impact. Please try your best to avoid such situation. This can be done by reducing the stated deceleration slope or lengthening the length between the negative limit and the mechanical limit.

### (3) execute the origin returning when the work table is in the positive limit

When the work station is in the positive limit, return to the origin can only be performed by default in the reverse return to the origin mode, no matter whether the direction of return to the origin is set as forward return to the origin or reverse return to the origin, as shown in the figure below:

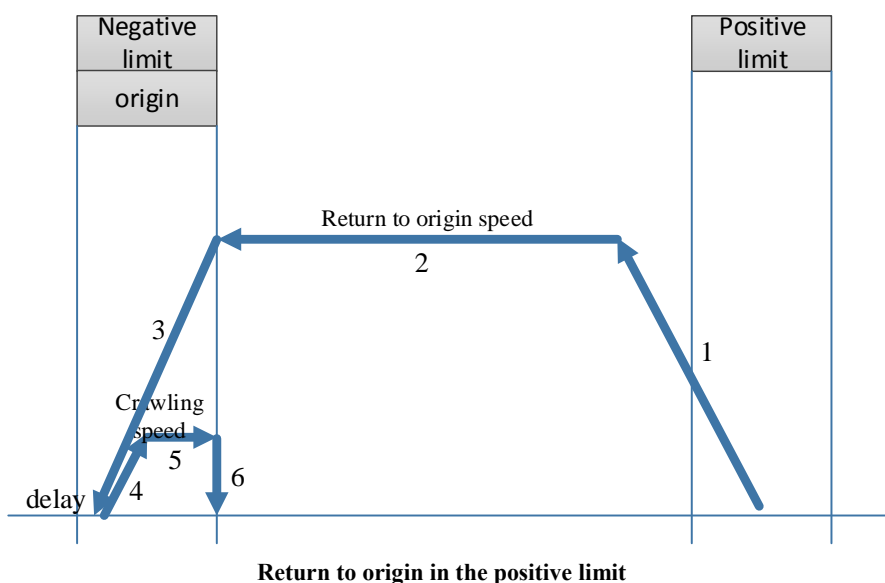
**Action:**

- (1) When the origin regression action starts, the acceleration is carried out first with the set acceleration slope, and accelerated to the origin regression speed, and then the regression speed of the origin is withdrawn back towards the direction of the origin.
- (2) When encountering the rising edge of the origin signal, slow down by the deceleration slope until complete rest (frequency =0).
- (3) delay (the direction delay time in SFD), then accelerated as the acceleration slope until reaching the crawling speed, then move forward, stop zero returning action at the moment of leaving the falling edge of origin signal (if it set Z phase pulse, it starts counting the Z phase after leaving the falling edge of the origin signal, stop zero returning action at once when the count value reached)
- (4) if "zeroing clear CLR signal" is set, it will output the clear signal immediately and delay (CLR signal delay time in SFD can be used to clear the Error Counter of the servo motor), At last, copy the mechanical origin position value to the current position and the zeroing action will be completed.

**Conclusion:**

In the above cases, as long as the rising edge of the origin signal is touched (the right edge of the origin), whether the acceleration has reached the speed of returning to the mechanical origin, is in the process of acceleration, or just accelerated to the speed of returning to the origin, the deceleration starts immediately according to the deceleration slope, until the deceleration is 0. Similarly, when the working table described below touches the rising edge of the negative limit (the right edge of the negative limit) and the rising edge of the positive limit (the left edge of the positive limit), please operate them in the same way.

Note:

- ※1: When the servo Z phase pulse is set, the Z phase pulse back to the origin capture function is effective, and the mechanical return to the origin will be stopped according to the Z phase mode.
- ※2: If the stopping position falls beyond the negative limit position, it may lead to machine

impact. Please try your best to avoid such situation. This can be done by reducing the stated deceleration slope or lengthening the length between the negative limit and the mechanical limit.

(4) execute origin returning when the work table is at the mechanical origin

When the worktable is at the mechanical origin, the worktable will return to the origin in positive direction no matter the setting direction is positive or negative, as shown in the figure below:

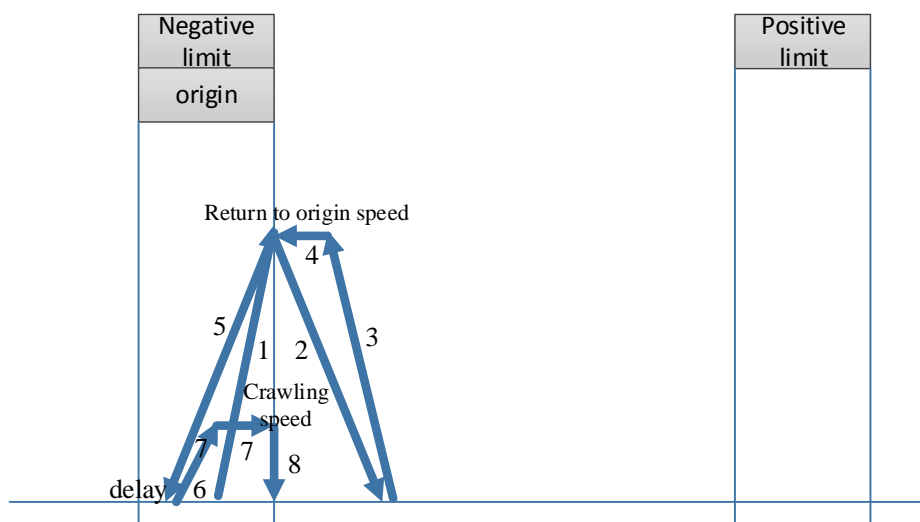

**Action:**

- (1) When the origin regression action starts, the acceleration is carried out first with the set acceleration slope, after accelerated to the origin regression speed, move forward towards mechanical origin falling edge direction with origin returning speed.
- (2) Whether or not the work table has been accelerated to the speed of the mechanical return to the origin according to the set acceleration slope, it will immediately begin to decelerate according to the set deceleration slope when leaving the descent edge of the mechanical origin until the speed acceleration is 0.
- (3) The working table immediately starts to accelerate to the speed of returning to the mechanical origin according to the set acceleration slope, and moves back toward the mechanical origin.
- (4) whatever the working table has been accelerated to the speed of mechanical return to the origin according to the set acceleration slope, when encountering the rising edge of the origin signal, the deceleration slope is used as the deceleration action until complete rest (frequency =0). Delay (the direction delay time in SFD), then accelerated as the acceleration slope until reaching the crawling speed, then move forward, stop zero returning action at the moment of leaving the falling edge of origin signal (if it set Z phase pulse, it starts counting the Z phase after leaving the falling edge of the origin signal, stop zero returning action at once when the count value reached)
- (4) if "zeroing clear CLR signal" is set, it will output the clear signal immediately and delay (CLR signal delay time in SFD can be used to clear the Error Counter of the servo motor), At last, copy the mechanical origin position value to the current position and the zeroing action will be completed.

**Conclusion:**

In the above cases, as long as the rising edge of the origin signal is touched (the right edge of the origin), whether the acceleration has reached the speed of returning to the mechanical origin, is in the process of acceleration, or just accelerated to the speed of returning to the origin, the deceleration starts immediately according to the deceleration slope, until the deceleration is 0. Similarly, when the working table described below touches the rising edge of the negative limit (the right edge of the negative limit) and the rising edge of the positive limit (the left edge of the positive limit), please operate them in the same way.

**Note:**

※1: When the servo Z phase pulse is set, the Z phase pulse back to the origin capture function is effective, and the mechanical return to the origin will be stopped according to the Z phase mode.

※2: When the return operation of the origin is started, it will be accelerated by the set acceleration slope first. No matter the speed is accelerated to the speed of mechanical return to the origin, the work table will start to decelerate according to the set deceleration slope as soon as it touches the decline edge of mechanical origin signal.

※3: When the table starts to accelerate towards the mechanical origin signal, whether it has accelerated to the speed of mechanical return to the origin or not, as long as the table touches the rising edge of the mechanical origin signal, it will immediately start to decelerate according to the set deceleration slope.

**(5) execute the origin returning when the work table exceeds the positive limit**

When the working table exceeds the positive limit, in order to prevent the occurrence of machine impact caused by positive return-to-origin, do not execute the return-to-origin. Please move the working table back to the negative(positive) limit or between the positive limit and the positive limit manually, and then execute the mechanical return-to-origin instruction!

The limit switch width of the negative limit and positive limit can also be widened to avoid the occurrence of breaking off the positive limit and negative limit when the pulse deceleration stops.

**(6) execute the origin returning when the work table exceeds the negative limit**

When the working table exceeds the negative limit, in order to prevent the occurrence of machine impact caused by positive return-to-origin, do not execute the return-to-origin. Please move the working table back to the negative(positive) limit or between the positive limit and the positive limit manually, and then execute the mechanical return-to-origin instruction!

The limit switch width of the negative limit and positive limit can also be widened to avoid the occurrence of breaking off the positive limit and negative limit when the pulse deceleration stops.

**Example 1**

As shown in the diagram below, one servo driver (electronic gear ratio is 1:1 by default) controls one servo motor (encoder 2500 lines), which is connected to the ball screw, whose pitch is 10mm. the ball screw drives workbench which can move right and left. Now the workbench needs to return to the origin, left limit switch connects the PLC input X0 (normally open), the right limit



switch connects the PLC input X2 (normally open), the origin position switch connects the PLC input X1 (normally open), the origin regression speed VH is 10000hz, direction delay time in SFD is 100 ms, crawling speed VC is 100hz, not count the Z phase signal, pulse output port is Y0, direction terminal is Y2, mechanical origin position is set to 0, accelerate slope is 1000hz per 100 ms, The deceleration slope is 1000Hz per 150ms.

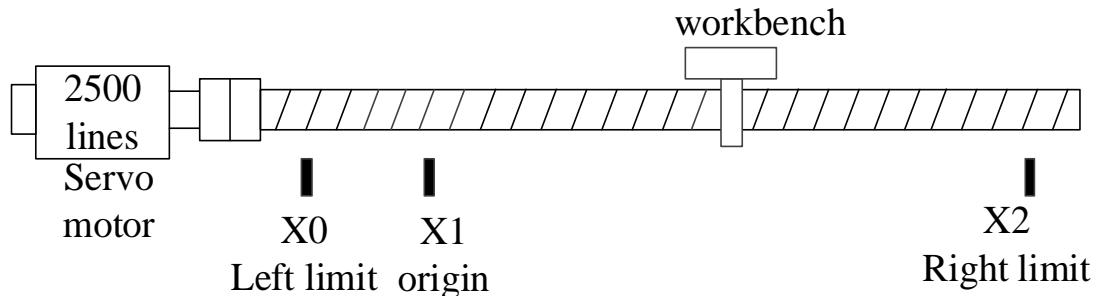

Structure diagram

➤ **The instruction to return to the mechanical origin**

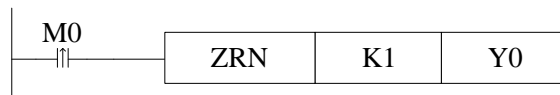

➤ **System parameter configurations**

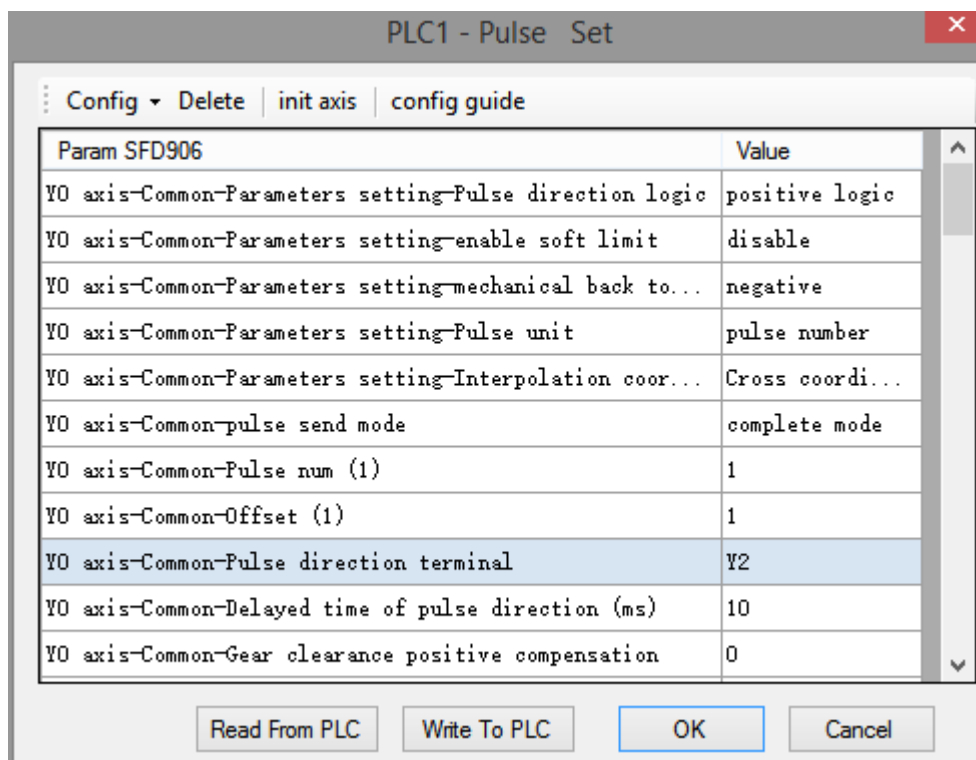

PLC1 - Pulse Set

Config ▾ Delete | init axis | config guide

Param SFD915 bit8-bit15	Value
Y0 axis-Common-Gear clearance positive compensation	0
Y0 axis-Common-Gear clearance negative compensation	0
Y0 axis-Common-Electrical origin position	0
Y0 axis-Common-signal terminal switch state setting...	normally on
Y0 axis-Common-signal terminal switch state setting...	normally on
Y0 axis-Common-signal terminal switch state setting...	normally on
Y0 axis-Common-signal terminal switch state setting...	normally on
Y0 axis-Common-Far-point signal terminal setting	X1
Y0 axis-Common-Z phase terminal setting	X no terminal
Y0 axis-Common-positive limit terminal setting	X2
Y0 axis-Common-negative limit terminal setting	X0

Read From PLC Write To PLC OK Cancel

PLC1 - Pulse Set

Config ▾ Delete | init axis | config guide

Param SFD936(dword)	Value
Y0 axis-Common-positive limit terminal setting	X2
Y0 axis-Common-negative limit terminal setting	X0
Y0 axis-Common-Zero clear CLR output setting	Y no terminal
Y0 axis-Common-Return speed VH	10000
Y0 axis-Common-Creeping speed VC	100
Y0 axis-Common-Mechanical zero position	0
Y0 axis-Common-Z phase num	0
Y0 axis-Common-CLR signal delayed time (ms)	100
Y0 axis-Common-grinding wheel radius(polar Interpola...	0
Y0 axis-Common-soft limit positive value	0
Y0 axis-Common-soft limit negative value	0

Read From PLC Write To PLC OK Cancel

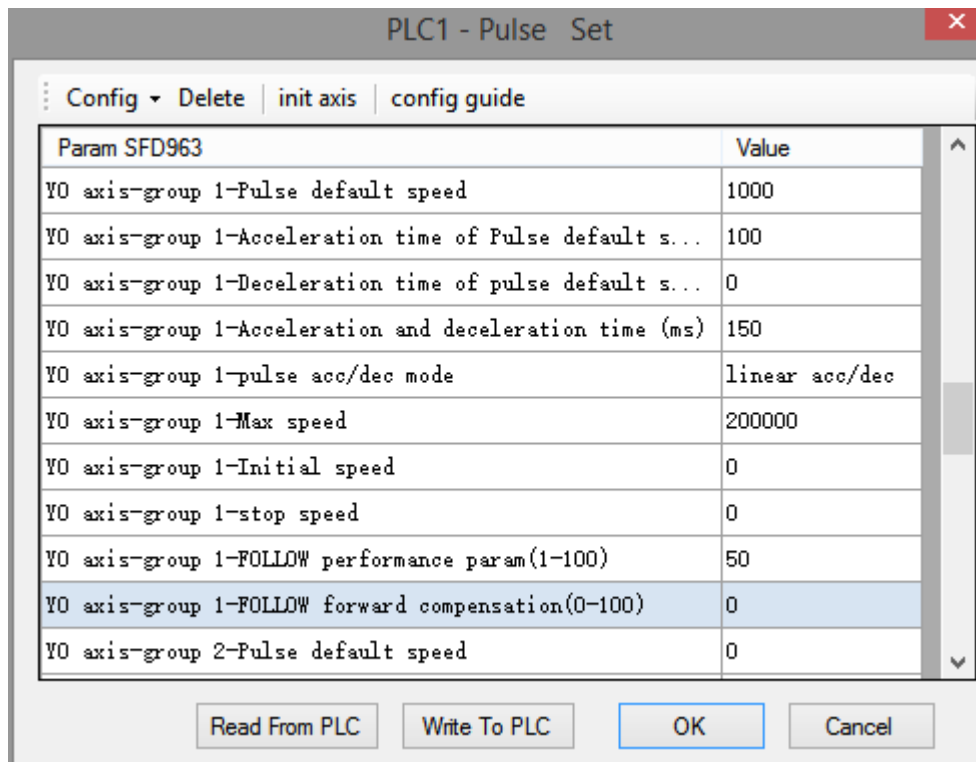

➤ Mechanical origin regression motion diagram

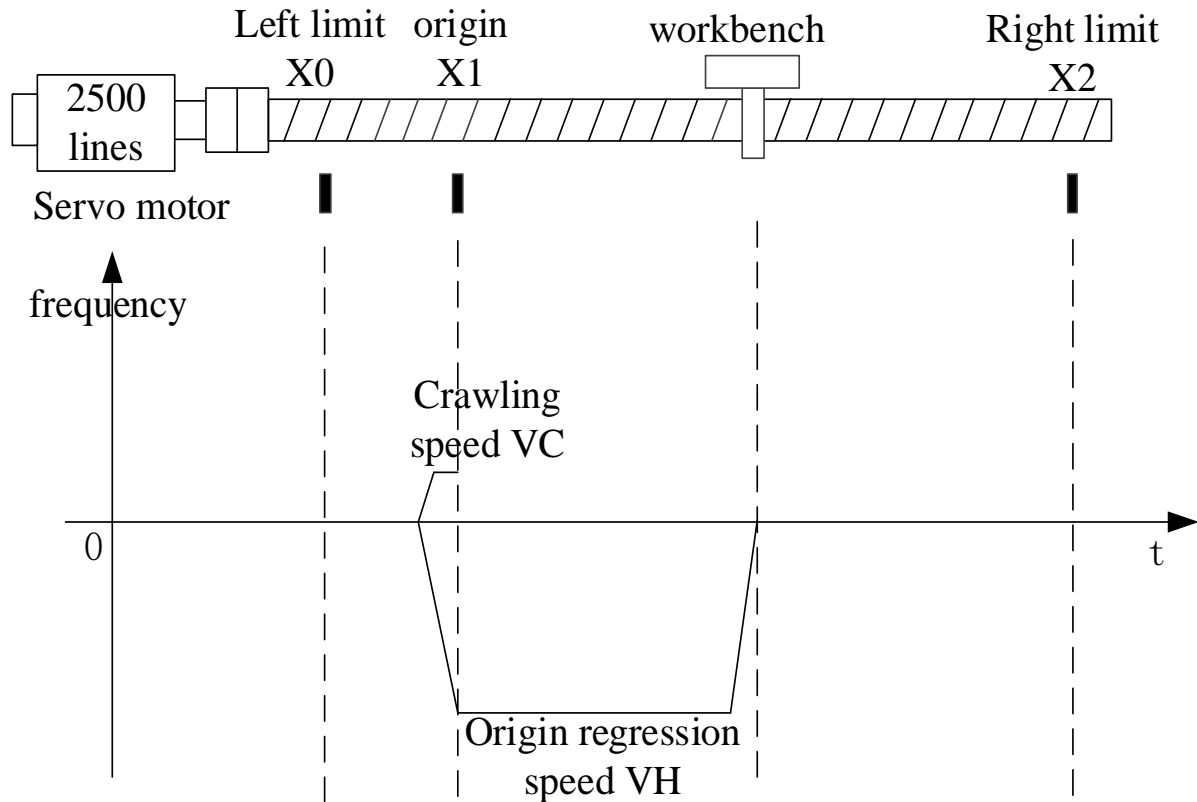

- in the moment of leaving the falling edge of origin signal X1 with crawling speed, the mechanical origin regression end immediately.
- if origin regression speed, acceleration/deceleration time, and left limit origin position settings are unreasonable, in the deceleration process of touching the origin signal it has already touched left limit, although there are solutions for such special cases inside the software, we try our best to avoid such special cases in the design of the solution. Special circumstances are not explained here.
- Y2 pulse direction terminal always keeps OFF when the workbench is moving from right to left, Y2 is ON when reverse moving with crawling speed until stop.

### Example 2

As shown in the diagram below, one servo driver (electronic gear ratio is 1:1 by default) controls one servo motor (encoder 2500 lines), which is connected to the ball screw, whose pitch is 10mm. the ball screw drives workbench which can move right and left. Now the workbench needs to return to the origin, left limit switch connects the PLC input X0 (normally open), the right limit switch connects the PLC input X2 (normally open), the origin position switch connects the PLC input X1 (normally open), the origin regression speed VH is 10000hz, direction delay time in SFD is 100 ms, crawling speed VC is 100hz, count the Z phase signal when reverse leaving the origin signal(connects to PLC input X4), Z phase number is set to 6, pulse output port is Y0, direction terminal is Y2, mechanical origin position is set to 0, accelerate slope is 1000hz per 100 ms, The deceleration slope is 1000Hz per 150ms.

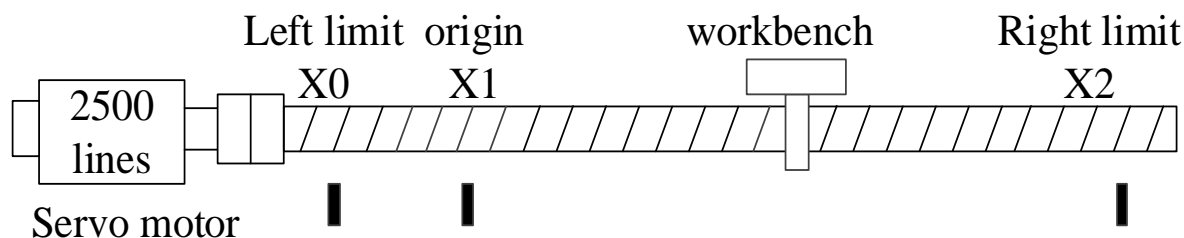

Structure diagram

#### ➤ The instruction of origin regression

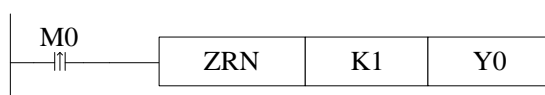

#### ➤ System parameter configurations

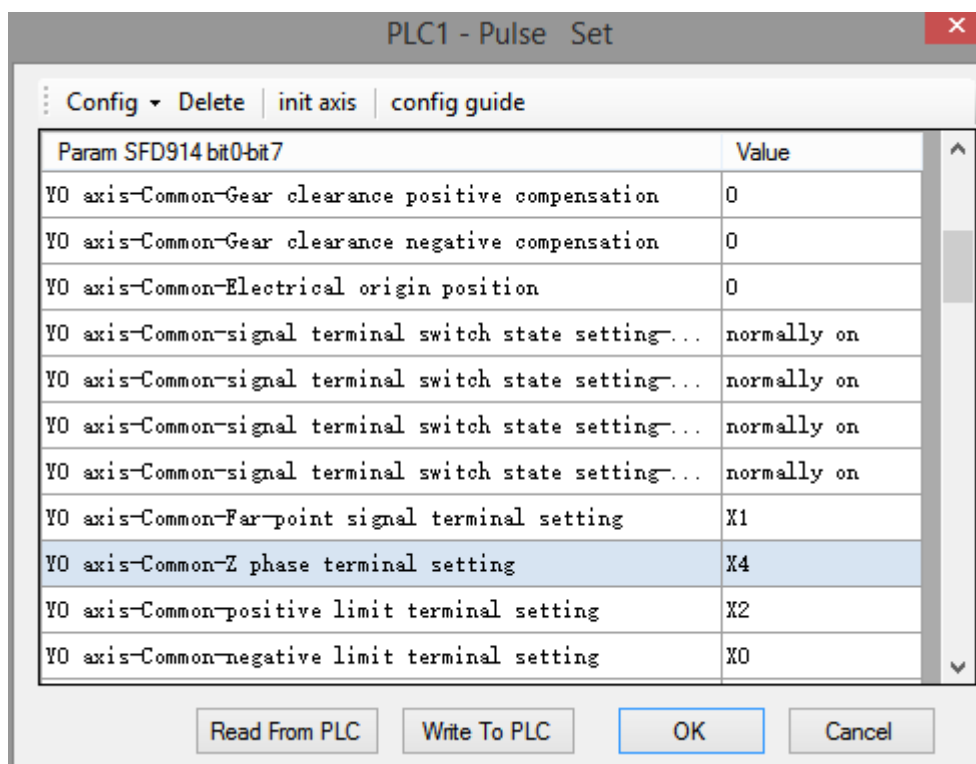
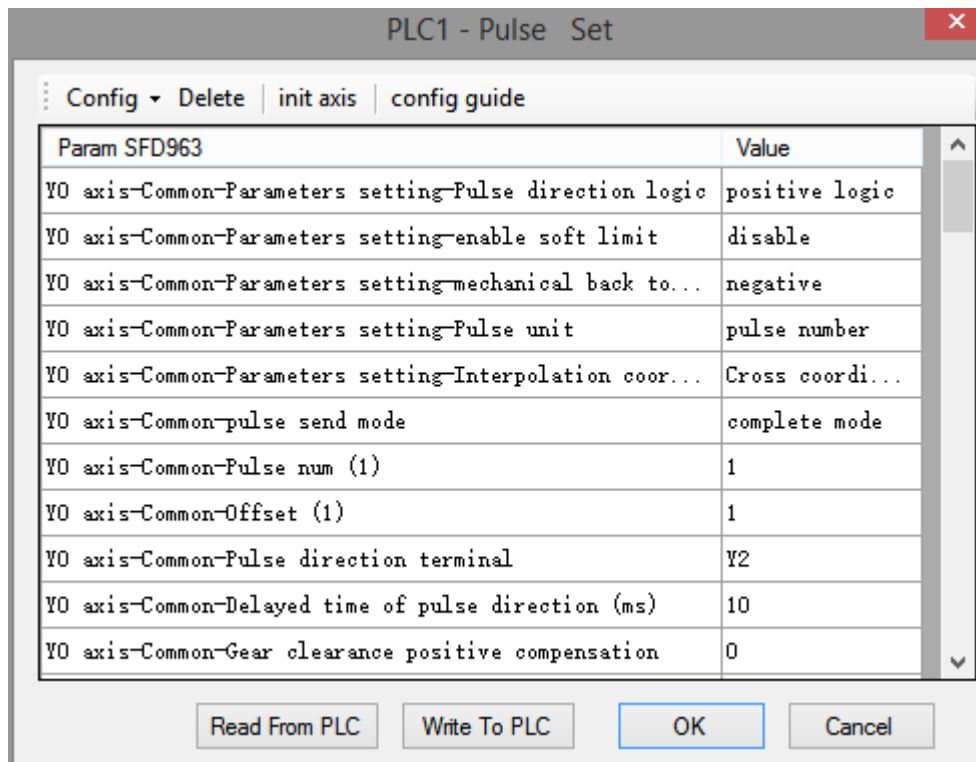

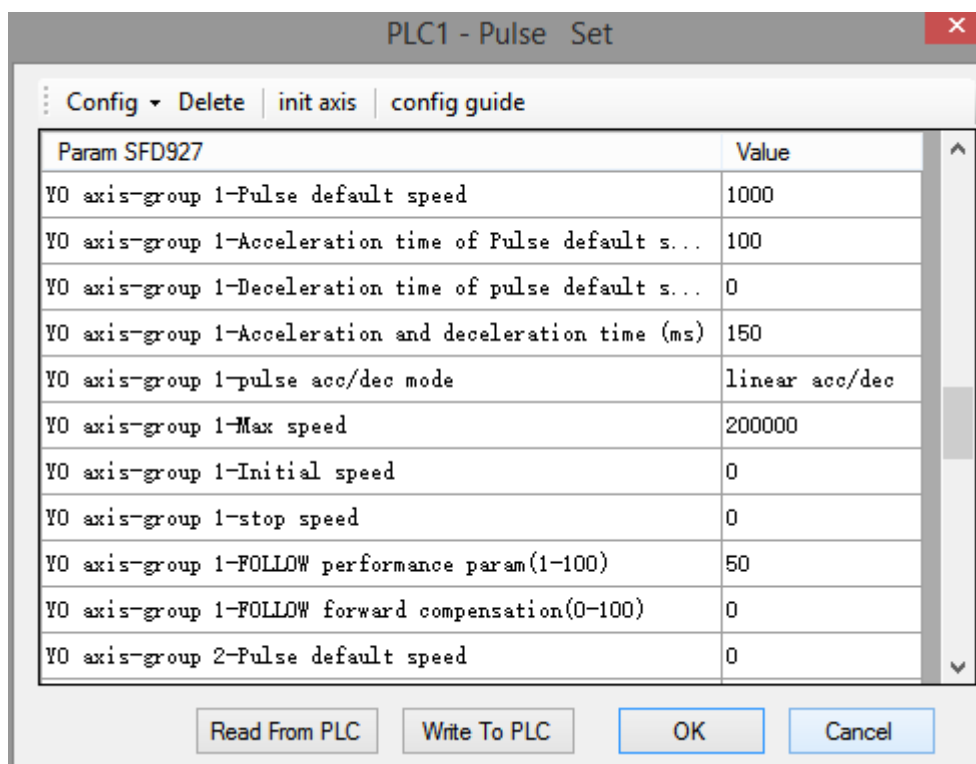
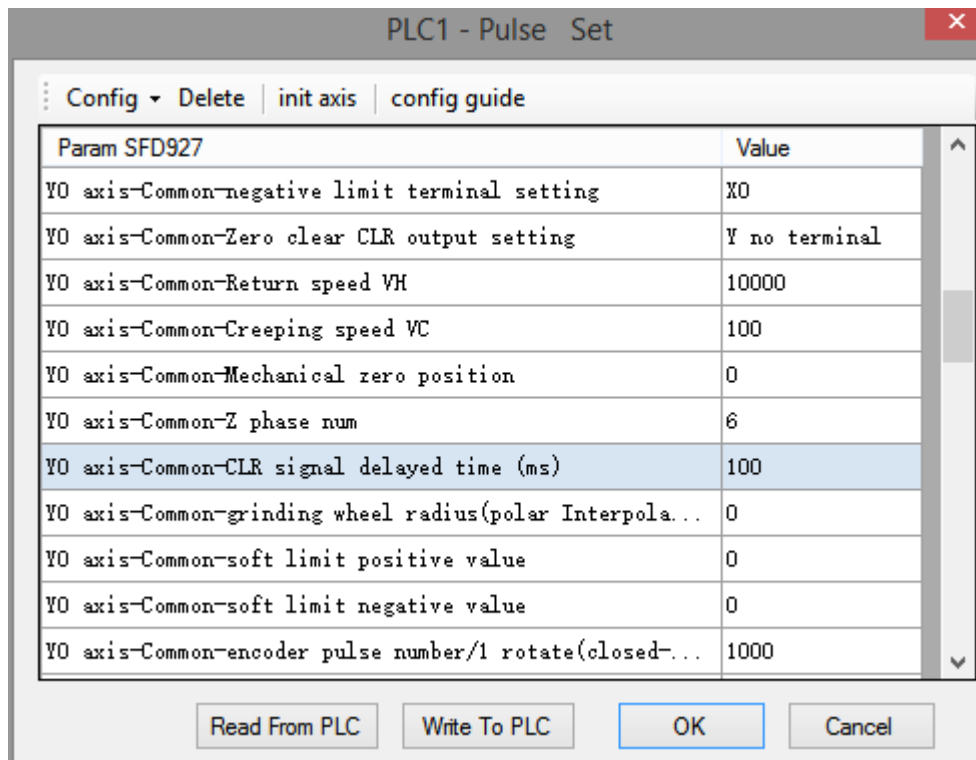

➤ **Mechanical origin regression motion diagram**

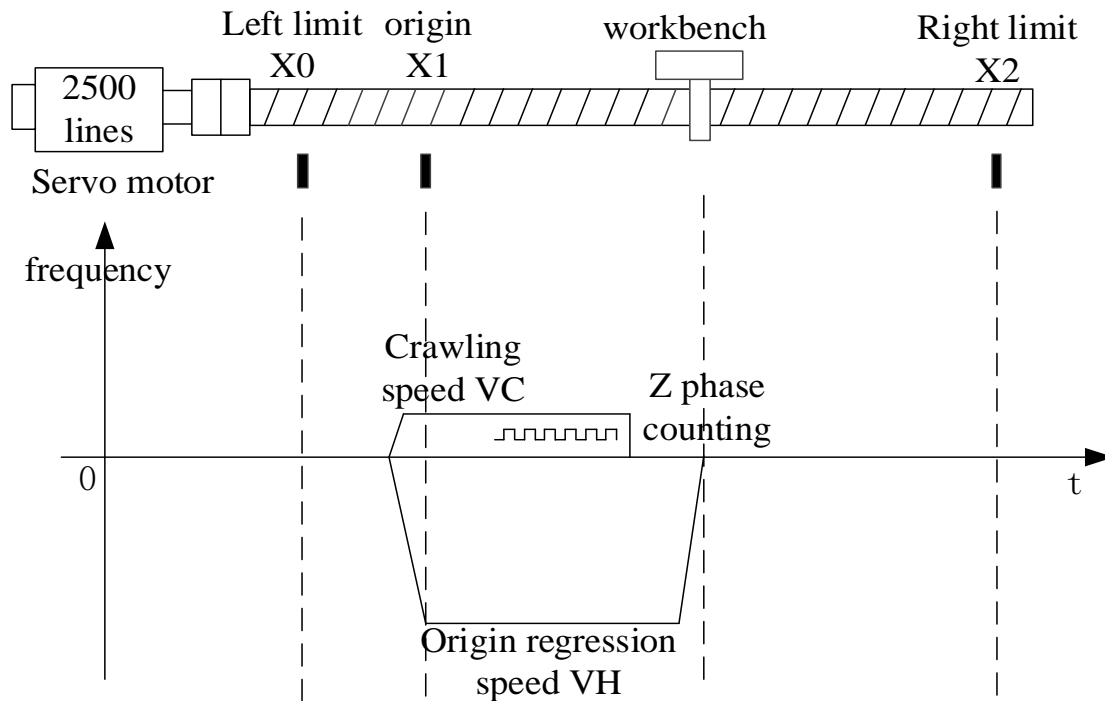

- When leaving origin signal X1 with crawling speed, count Z phase at once, pulse stop at once when the Z phase counting value reached, the mechanical origin regression end immediately.
- if origin regression speed, acceleration/deceleration time, and left limit origin position settings are unreasonable, in the deceleration process of touching the origin signal it has already touched left limit, although there are solutions for such special cases inside the software, we try our best to avoid such special cases in the design of the solution. Special circumstances are not explained here.
- Y2 pulse direction terminal always keeps OFF when the workbench is moving from right to left, Y2 is ON when reverse moving with crawling speed until stop.

### 1-2-7. Pulse stop [STOP]

#### 1. deceleration stop pulse outputting

Pulse stop [STOP]			
16-bit instruction	STOP	32-bit instruction	-
Execution condition	Rising edge /falling edge of the coil	Suitable model	XD, XL (except XD1, XL1)
Hardware	-	Software	-

#### 2. Operand

Operand	Function	Type
S	The terminal to stop the pulse outputting	bit
D	Pulse stop mode ( 0: stop slowly, 1: scram)	16-bit, word

#### 3. Suitable soft component

word	operand	System							constant	Module	
		D*	FD	TD*	CD*	DX	DY	DM*	DS*	K/H	ID
	D	•	•	•	•	•	•	•			
bit	Operand	System									
		X	Y	M*	S*	T*	C*	Dnm			
	S		•								

\*Note: D means D, HD; TD means TD, HTD; CD means CD, HCD, HSCD, HSD. DM means DM, DHM;

DS means DS, DHS.

M means M, HM, SM; S means S, HS; T means T, HT; C means C, HC.

#### Function and action

#### Instruction format

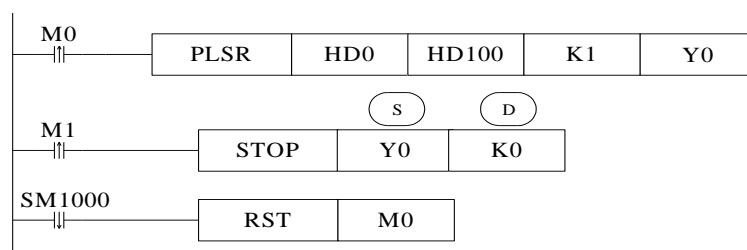

- Pulse stop mode: K0 (stop slowly), K1(scram)
- When M0 is from OFF to ON, PLSR instruction outputs pulse from Y0, and stop pulse outputting when the pulse output numbers reached setting value
- At the rising edge of M1, STOP instruction will stop the pulse outputting of Y0 immediately,



as the D parameter is K0, the pulse will stop slowly.

- Stop pulse includes PLSR, PLSF, DRVI, DRVA, ZRN.
- Stop slowly (K0)

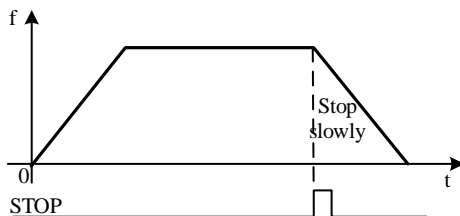

According to the descending slope, the current pulse frequency of the pulse falls to the pulse stop frequency or the number of pulses in the pulse section is all sent out and stop the pulse output.

- Scram (K1)

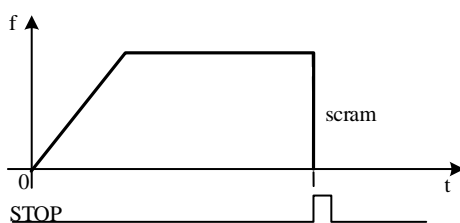

Stop the pulse outputting immediately.

### 1-2-8. Pulse continue [GOON]

#### 1. Instruction overview

Continue the pulse output.

Pulse continue [GOON]			
16-bit instruction	GOON	32-bit instruction	-
Execution condition	Rising/falling edge of the coil	Suitable model	XD, XL (except XD1, XL1)
Hardware	-	Software	-

#### 2. Operand

Operand	Function	Type
S	The terminal to continue outputting the pulse	bit

## 3. Suitable soft component

Bit	Operand	System						
		X	Y	M*	S*	T*	C*	Dnm
S			•					

\*Note: D means D, HD; TD means TD, HTD; CD means CD, HCD, HSCD, HSD. DM means DM, DHM;

DS means DS, DHS.

M means M, HM, SM; S means S, HS; T means T, HT; C means C, HC.

**Function and action**

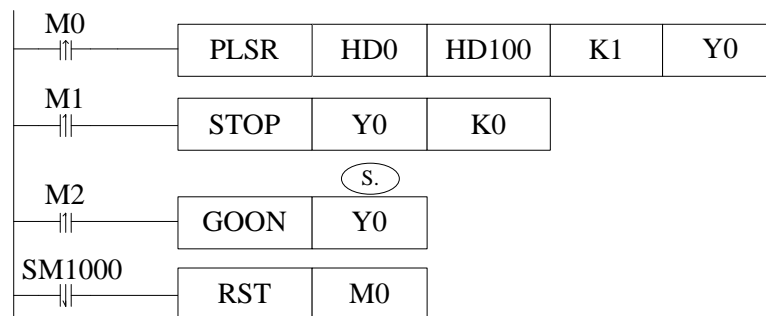
**Instruction format**

- When M0 from OFF to ON, PLSR instruction outputs pulse from Y0; When the number of output pulses reaches the set value, stop the output pulse.
  - In the process of sending pulse, M1 from OFF to ON rising edge, STOP instruction immediately stop Y0 pulse outputting, as the parameter is K0, so the pulse will stop slowly;
  - when M2 from OFF to ON rising edge, GOON Y0 instruction is executed, remaining pulses will send out according to the original deceleration slope.
  - Please set ON M2 after pulse stop, otherwise GOON will not send pulse.
  - Pulse continue instruction is applicable to the PLSR, DRVI, DRVA instructions.
- The schematic diagram is as follows:

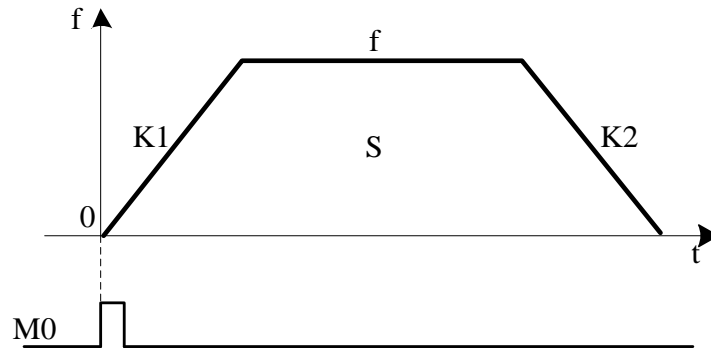

Complete Pulse diagram

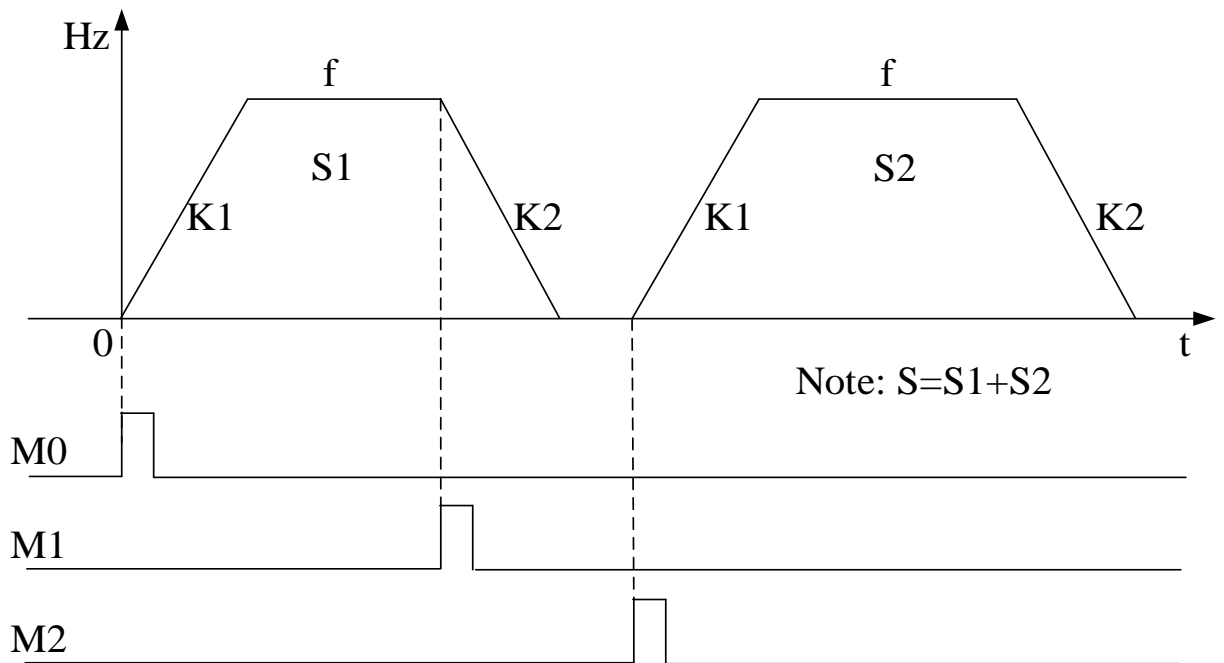

Pulse continue wave diagram (STOP Y0 K0)

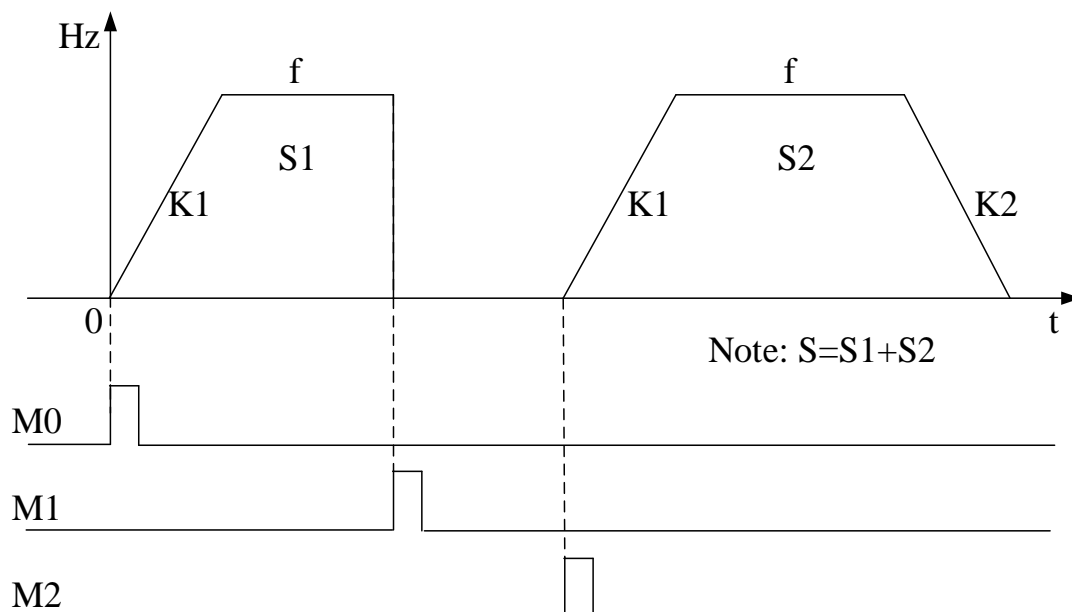

Pulse continue wave diagram (STOP Y0 K1)

### 1-3. Pulse parameter configuration wizard

Pulse parameter configuration wizard function was added in V3.3.2 and higher version software. Because there are many system parameters of the pulse axis (including common parameters and the first to fourth sets of parameters), it may be difficult for novices. To solve this problem, a pulse parameter configuration wizard is added to the latest PC software, which configures the pulse parameters of each pulse axis directly through the pulse parameter configuration wizard, which is simple and convenient.

#### 1-3-1. Pulse Parameter Configuration Wizard Opening Mode

On the top of the pulse parameter configuration interface, there is a "Config guide" option. Click on the "Configuration Wizard" to open the pulse parameter configuration wizard. As shown in the figure:

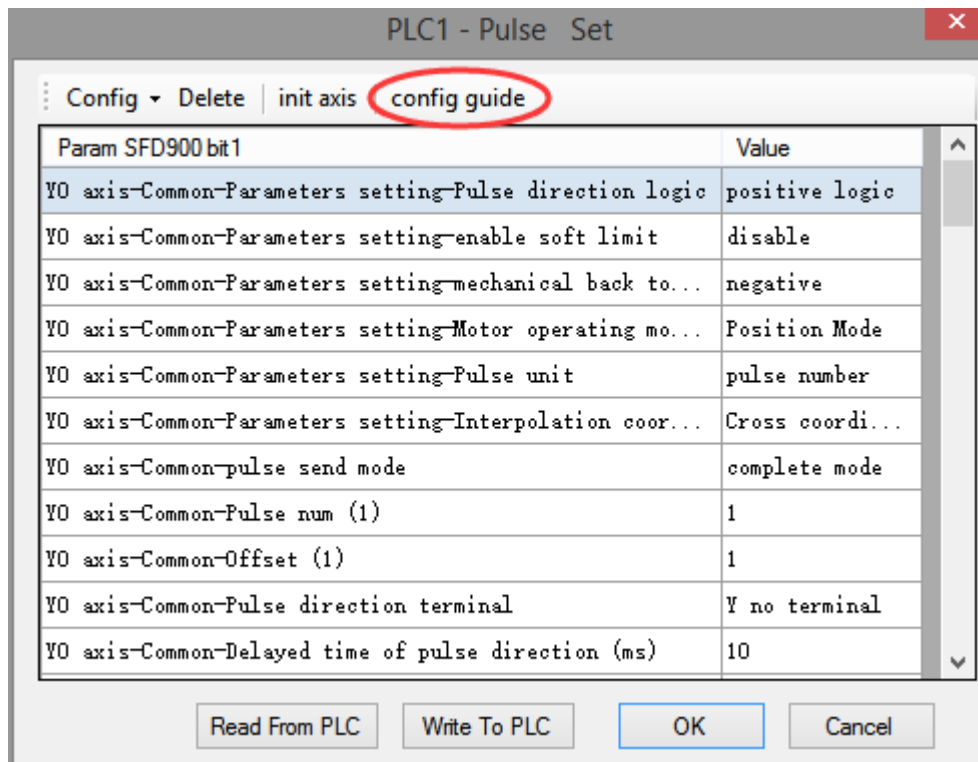

Engineering Tree is on the left of the following window. You can select the option you want to open in the Engineering Tree, and click directly to open it quickly. As shown in the figure:

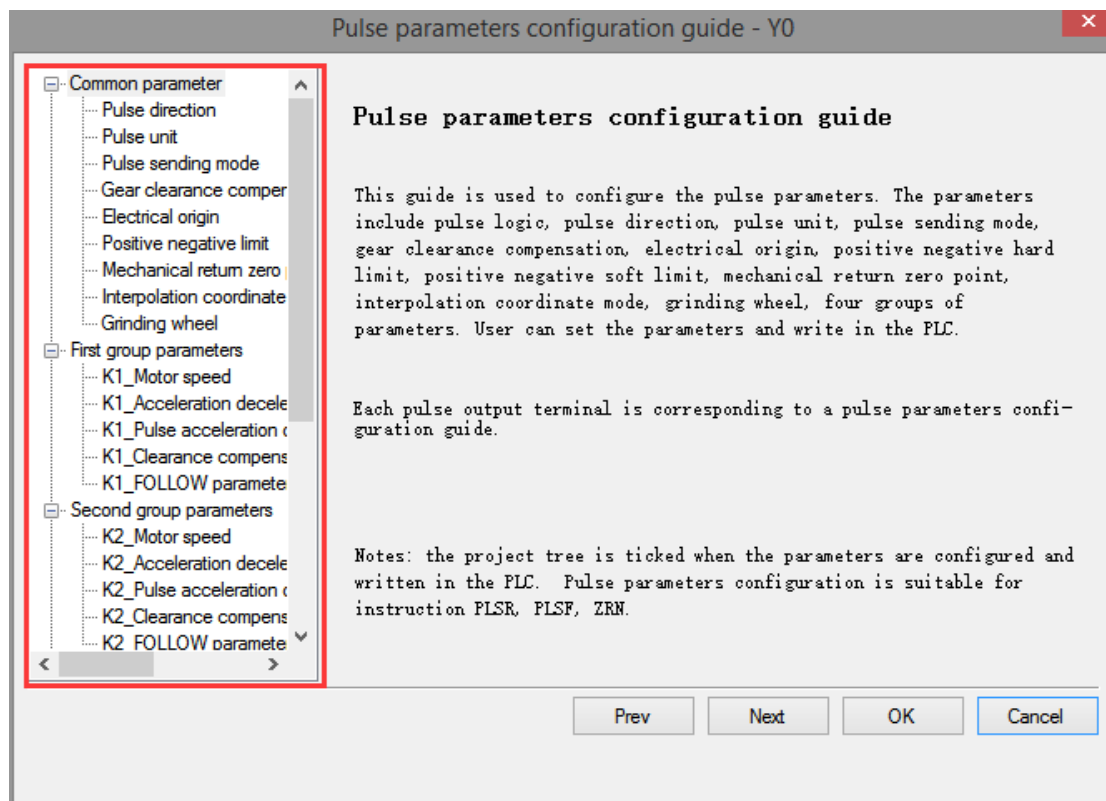

### 1-3-2. Instructions for the Use of the Pulse Parameter Config guide

The pulse parameter config guide describes:

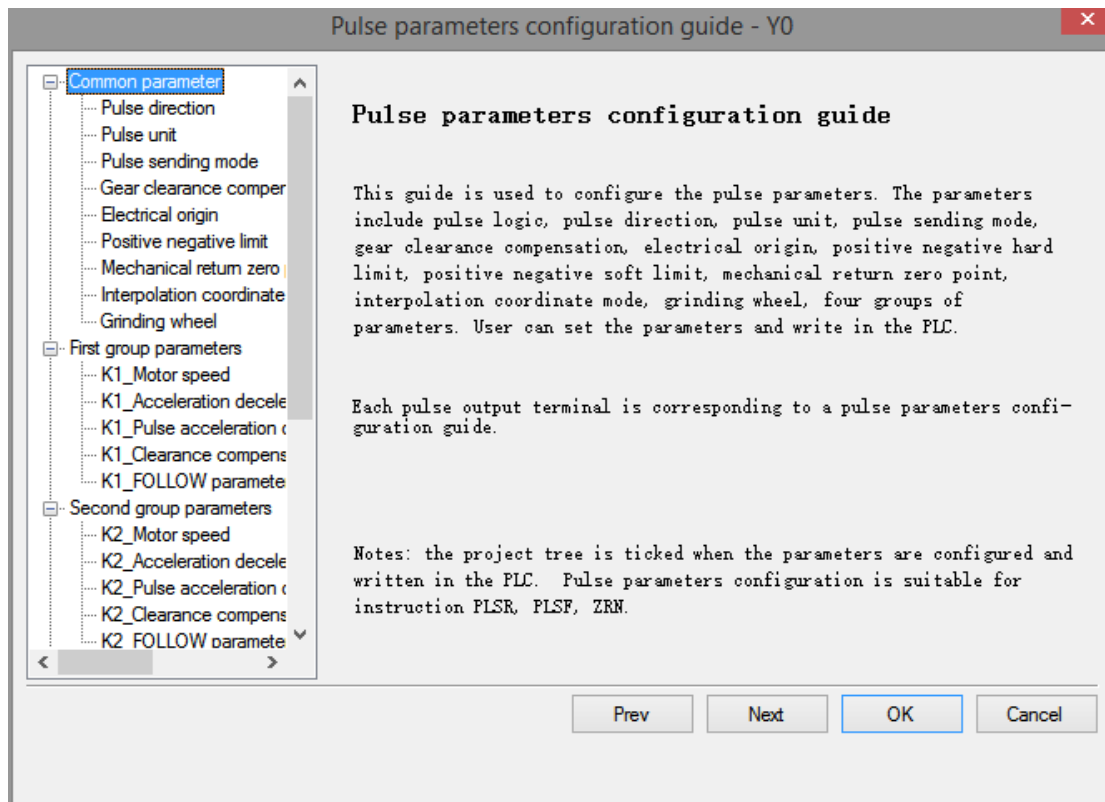

This interface is mainly used to briefly explain the pulse parameter configuration wizard.

#### ★ Common parameter—pulse direction

It is used to set the pulse direction logic, the pulse direction terminal and the delay time of the pulse direction.

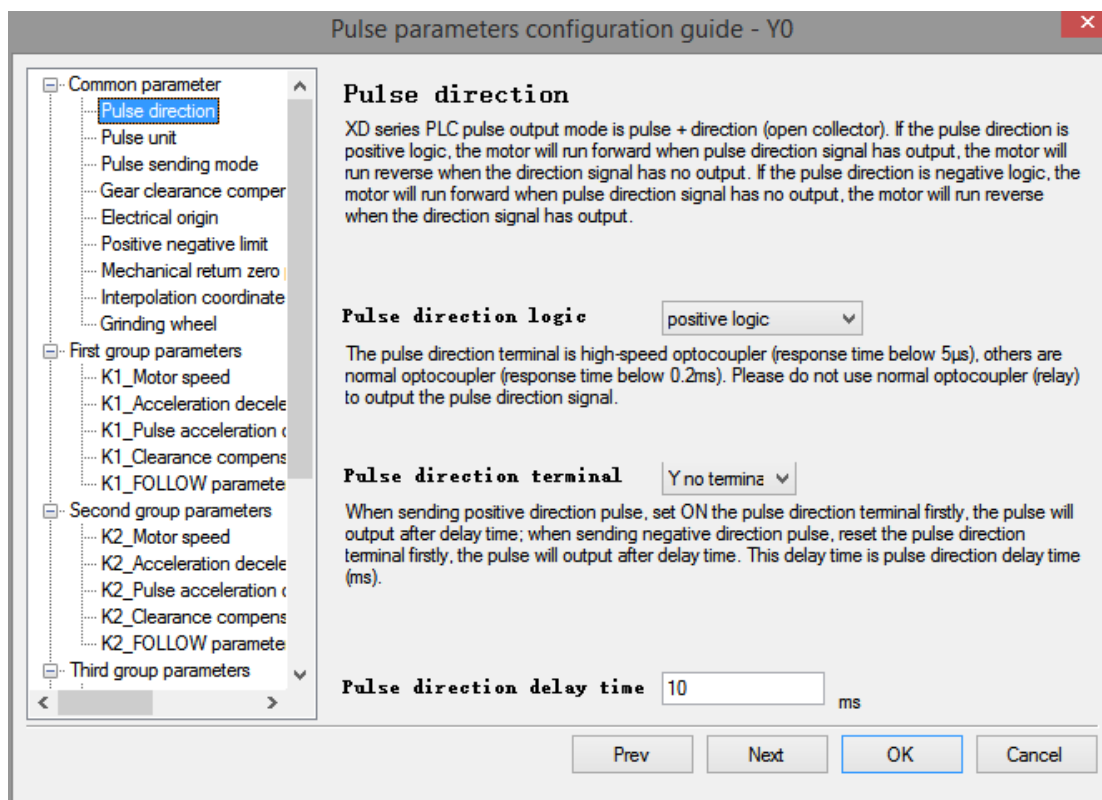

### ★ common parameters—pulse unit

It is used to set the unit of pulse, the basic unit of equivalent, the number of pulses and the amount of movement.

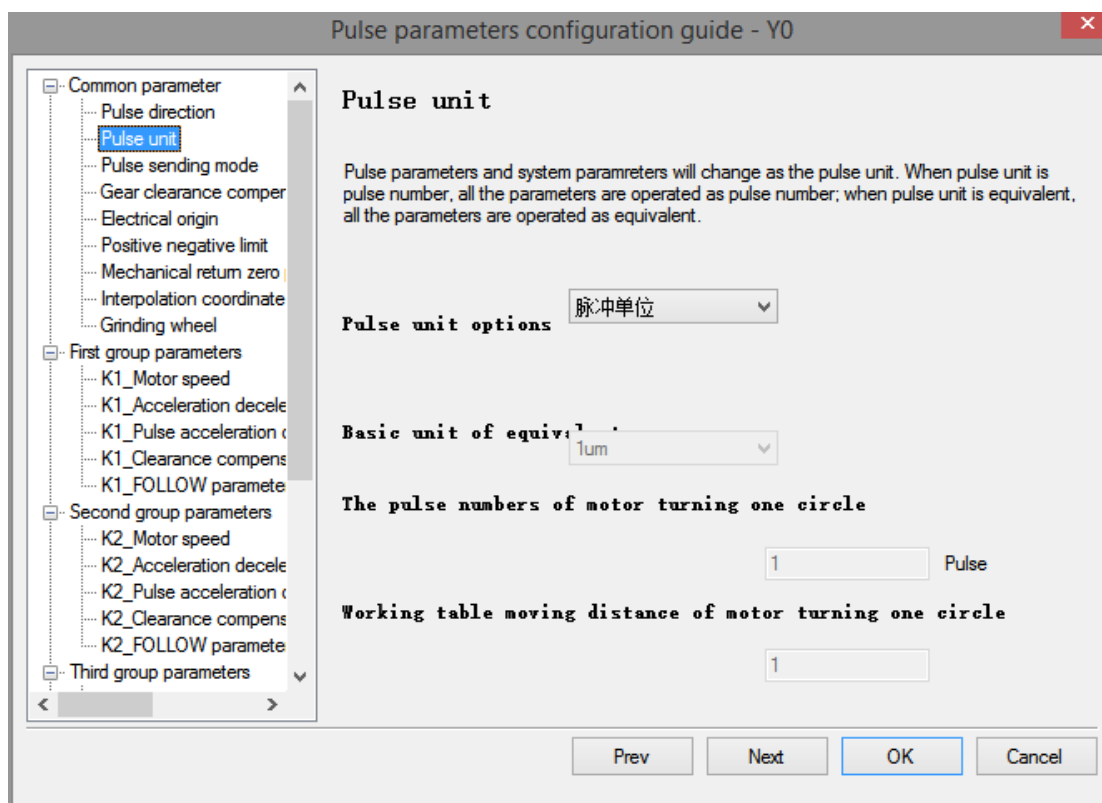

### ★ Common parameters—pulse sending mode

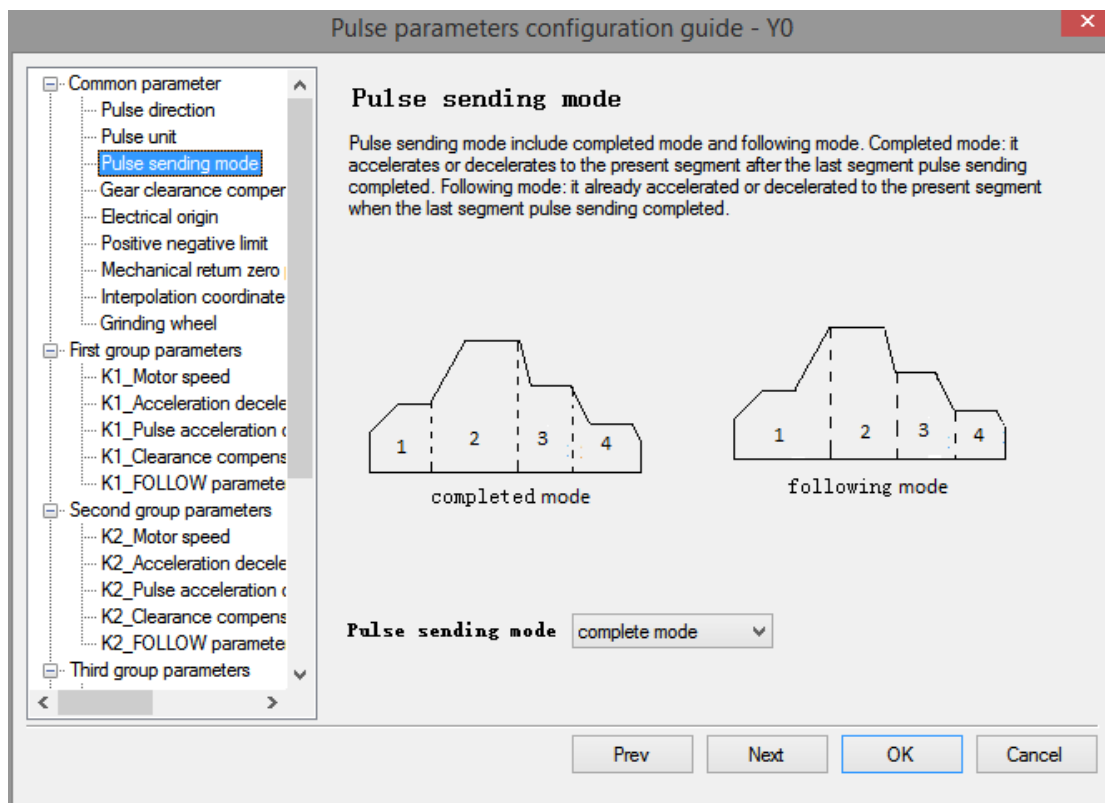

### ★ Common parameters—gear clearance compensation

It is used for setting forward compensation of gear clearance and reverse compensation of gear clearance.

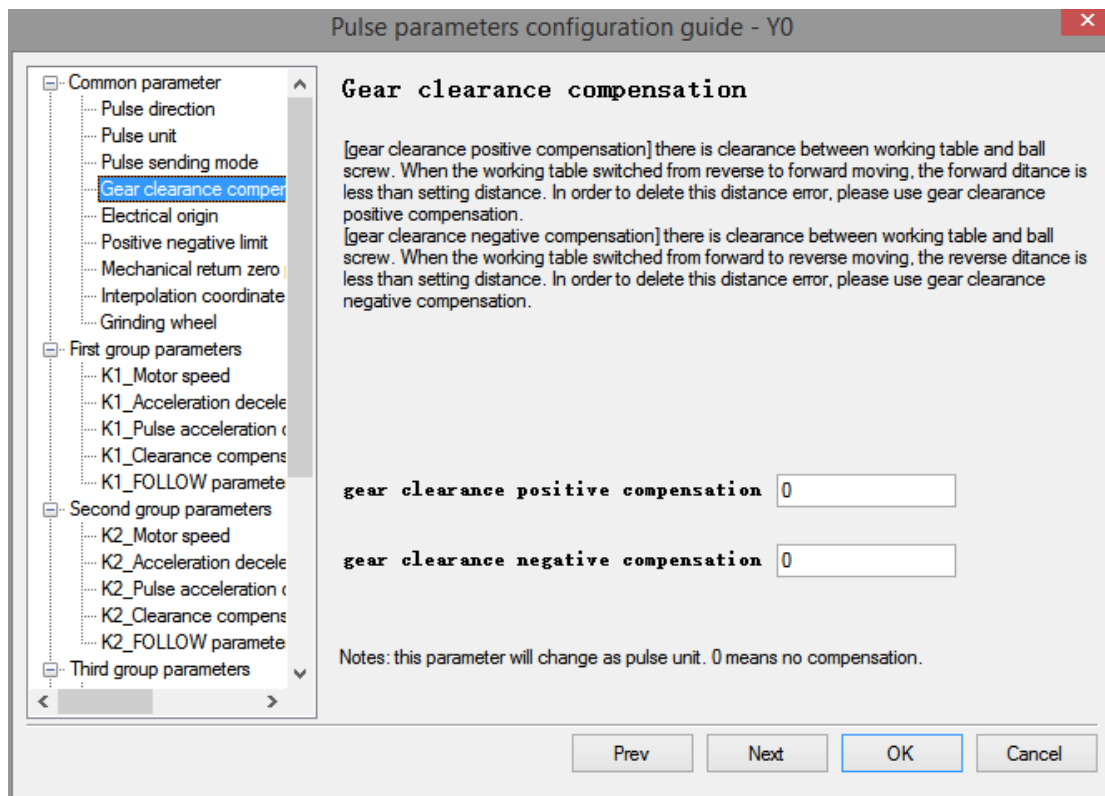



### ★ Common parameters —electric origin

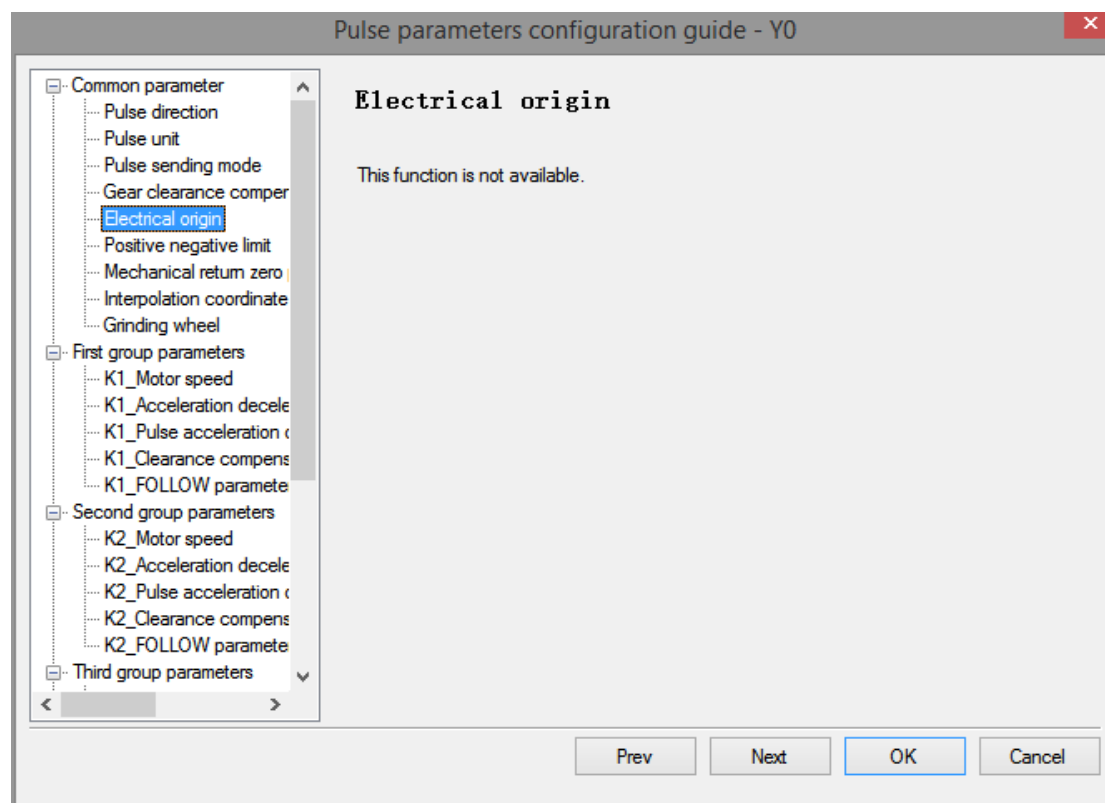

### ★ Common parameters—positive negative hard/soft limit

Used for setting positive and negative hard limit and positive and negative soft limit.

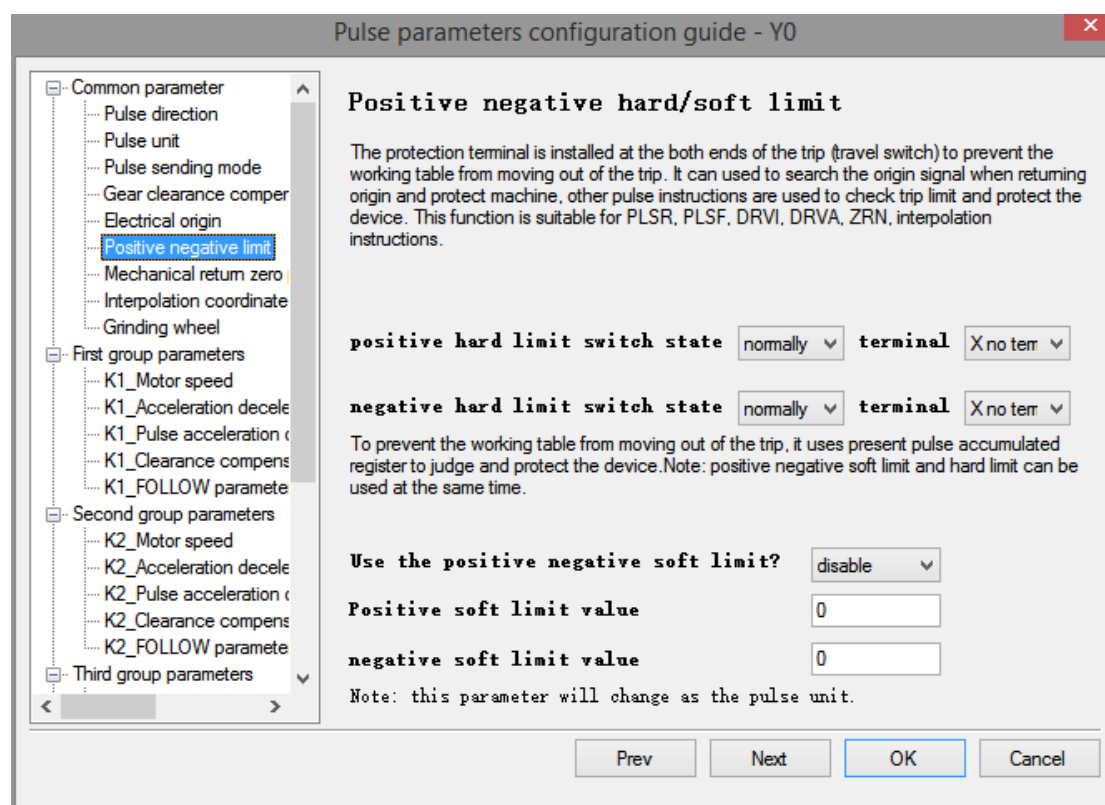

### ★ Common parameters—Mechanical Zero Return Setting

Used to set the default direction of mechanical zero return, origin switch, Z phase switch, regression speed, CLR signal, mechanical origin position.

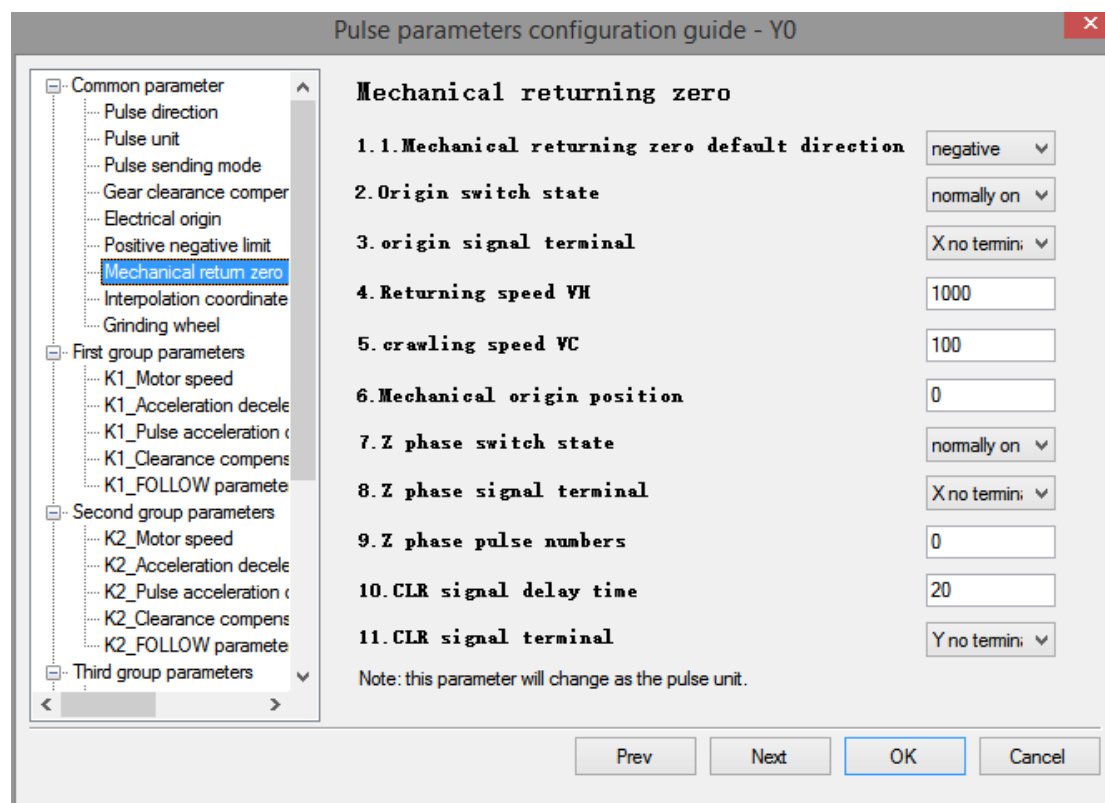

### ★ Common parameters —Interpolation coordinate mode

### ★ Common parameters —grinding wheel radius

The functions are not available.

## ★ First group parameter setting

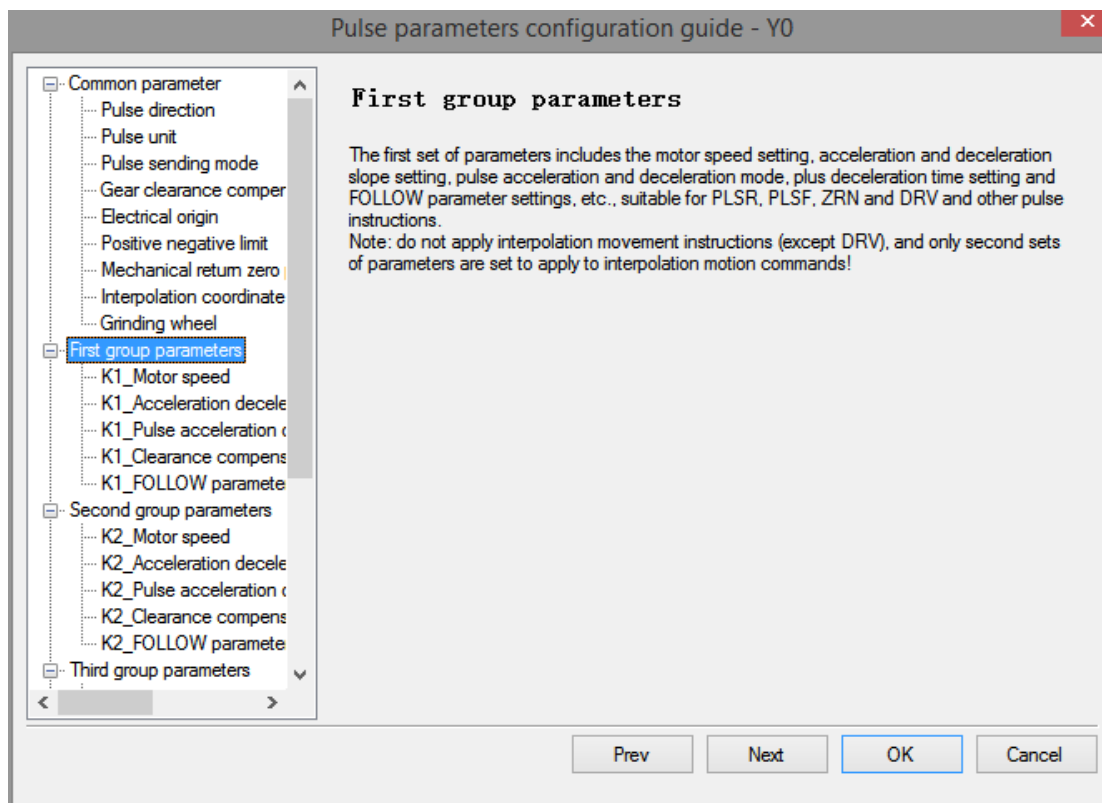

## ★ First group parameters—motor speed

Used to set the maximum speed, starting speed, termination speed.

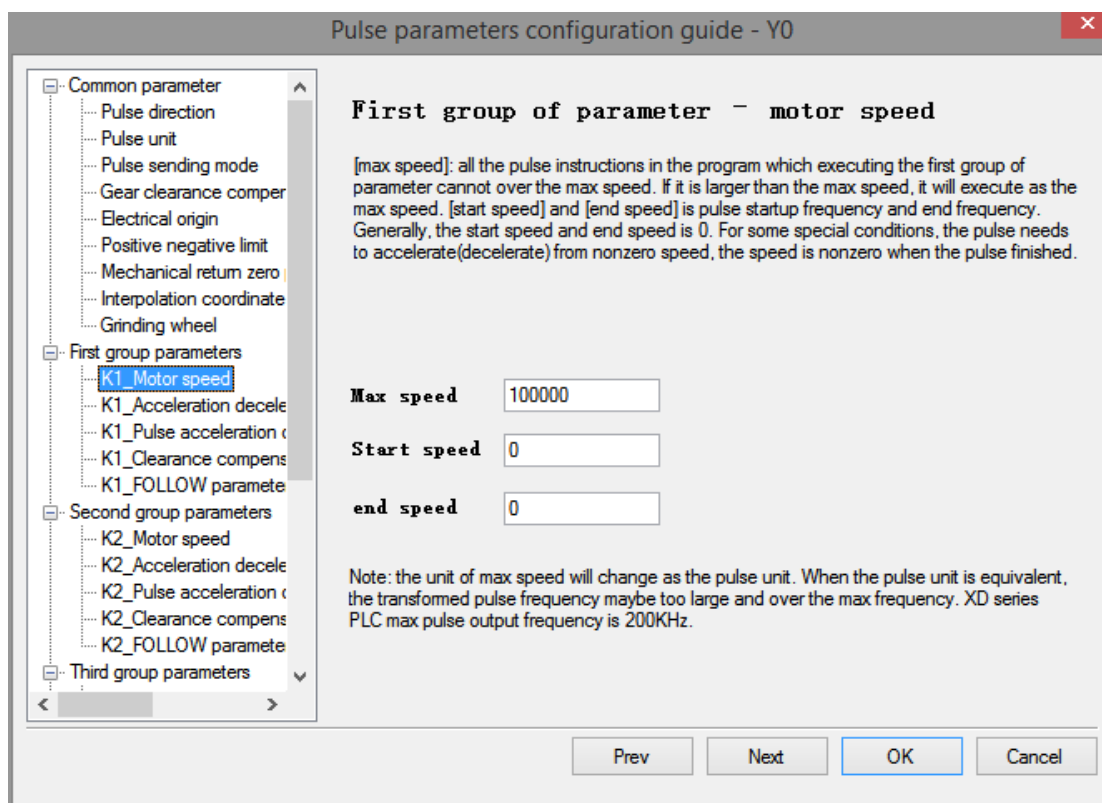

### ★ First group parameters —Acceleration and deceleration slope

Used to set default speed, default speed acceleration time, default speed deceleration time.

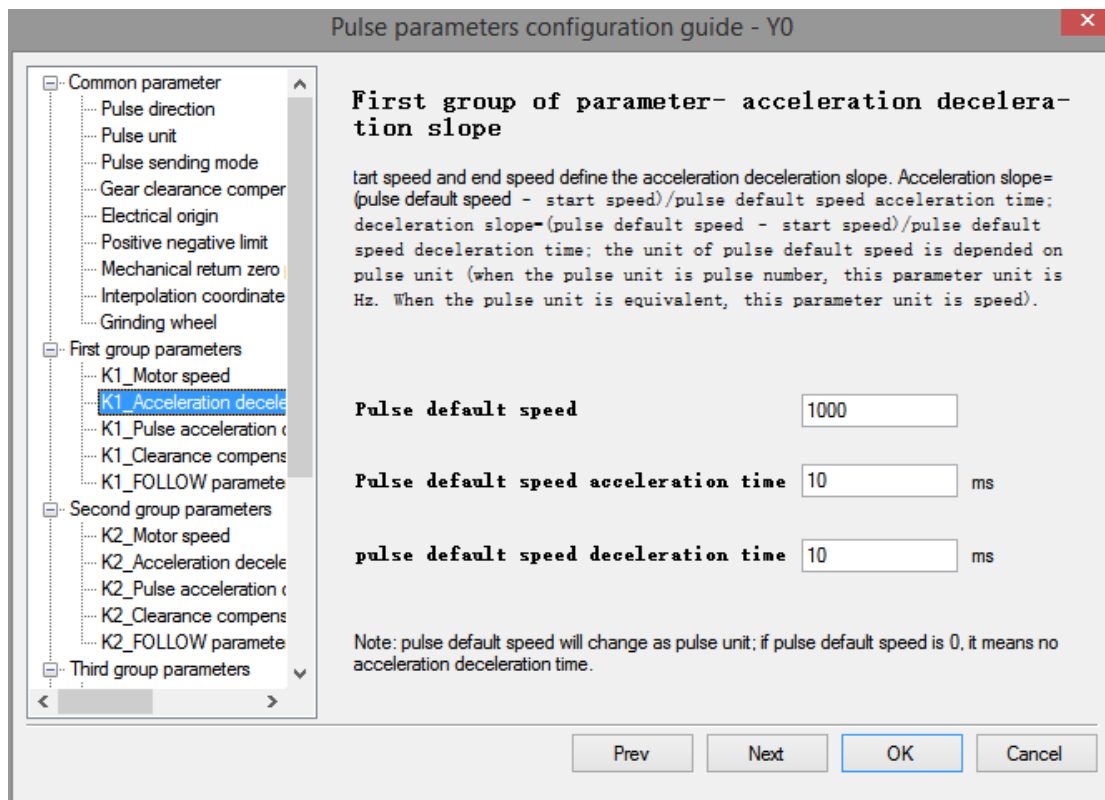

### ★ First group parameters —Pulse acceleration and deceleration mode

It is used to set three pulse acceleration and deceleration modes.

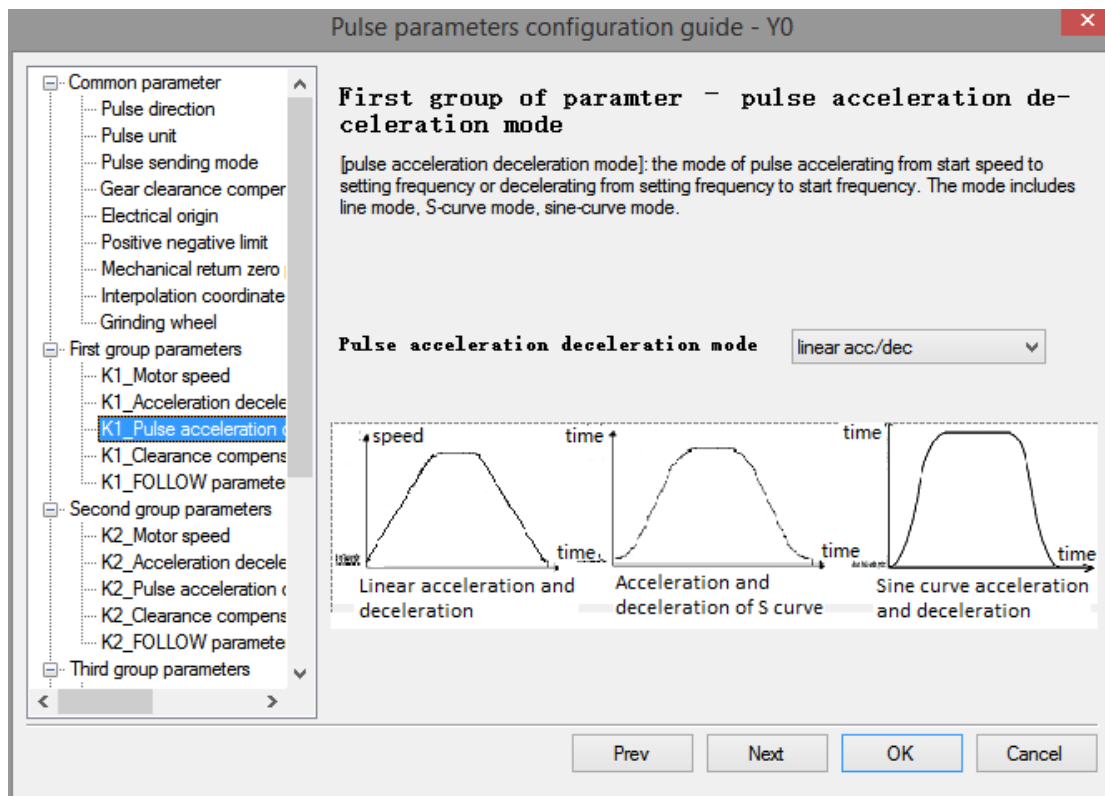

### ★ First group parameters —Clearance compensation acceleration and deceleration time

It is used to set the clearance compensation acceleration and deceleration time.

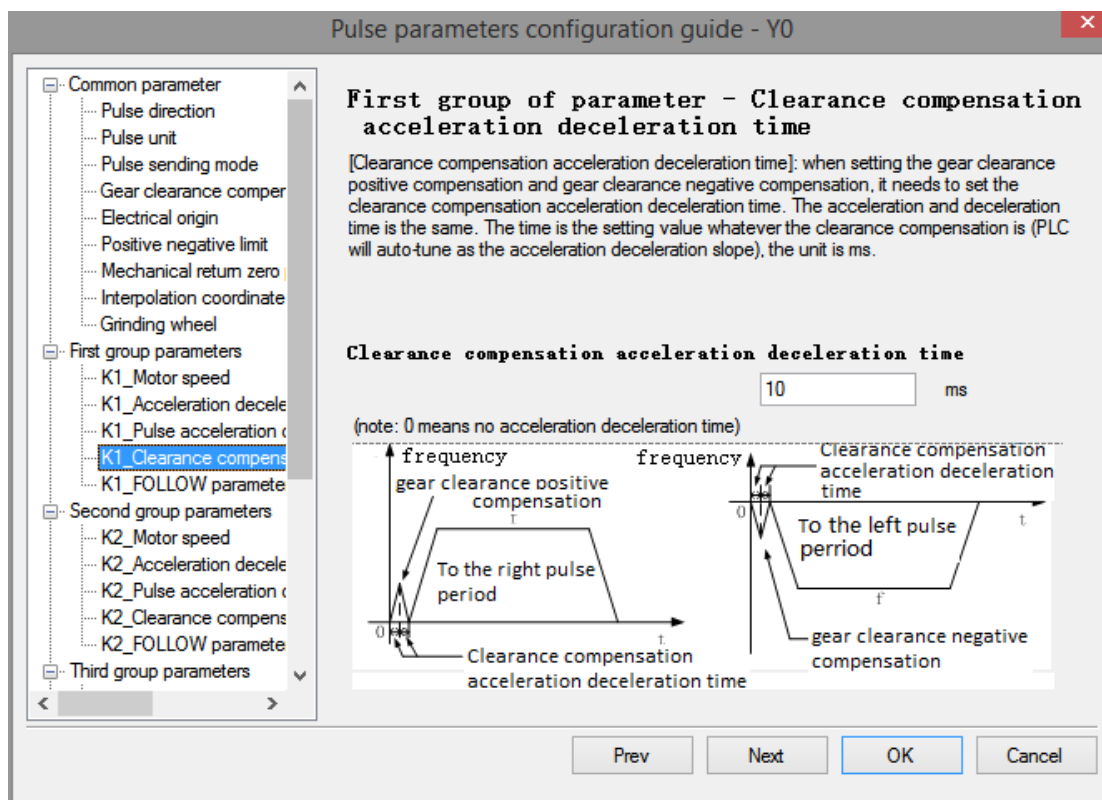

### ★ First group parameters —FOLLOW parameter

It is used to set the FOLLOW parameter and feedforward parameter.

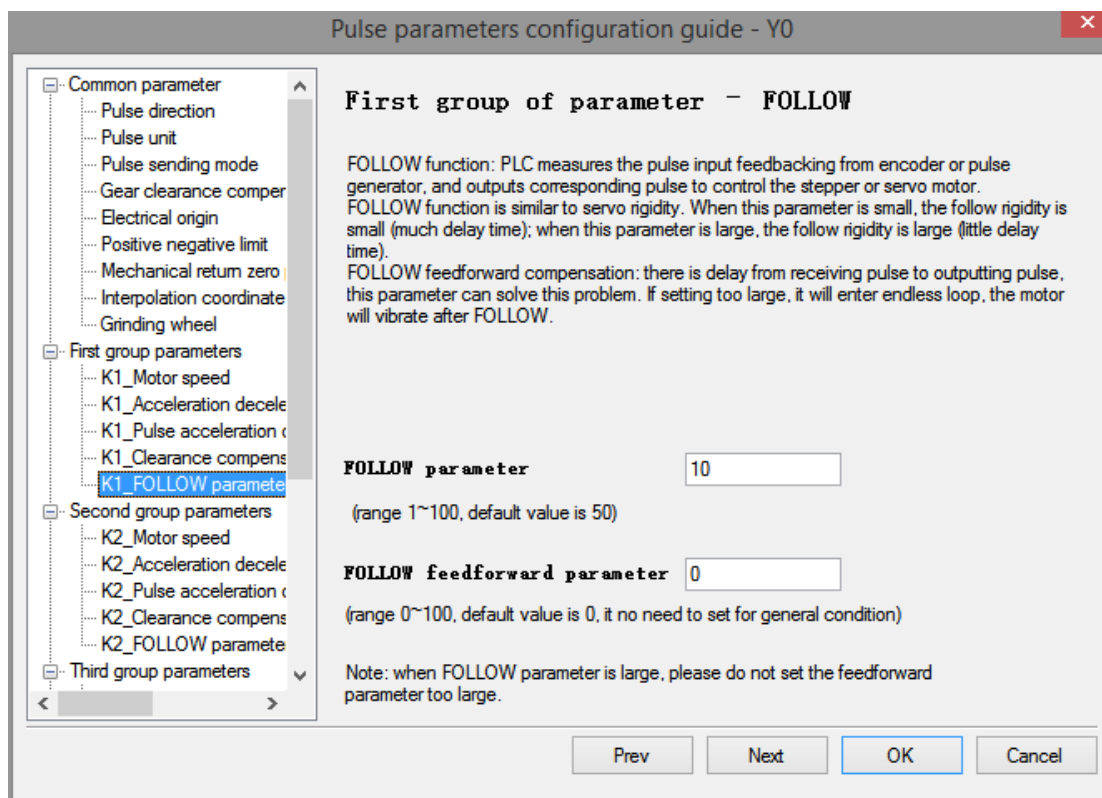

The second to fourth group of parameters are the same as the first group of parameters, please refer to the first group of parameters! After configuring the parameters, the program is downloaded to the PLC again, and then the power is cut off and restarted to take effect.

#### 1-4. Output wiring and notes

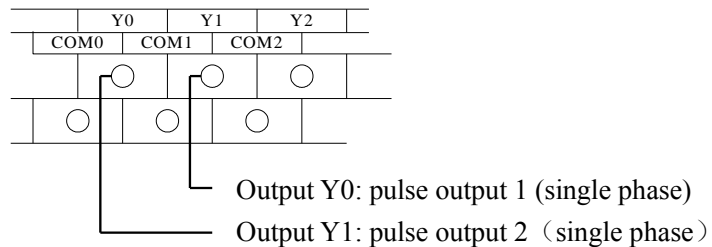

Below is a wiring diagram of the connection between the T-type output terminal and the stepper motor driver.

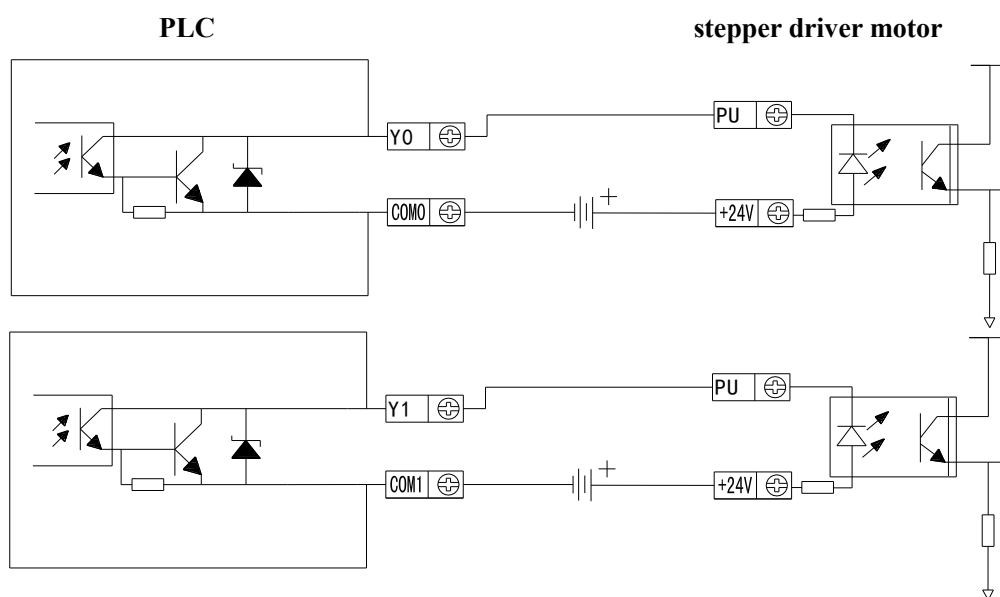

Note: If the pulse and direction terminals of stepper motor are driven by DC5V, please connect 2.2K resistance behind the pulse output terminal and direction output terminal.

Below is a wiring diagram of the connection between the T-type output terminal and the XINJE servo motor driver.

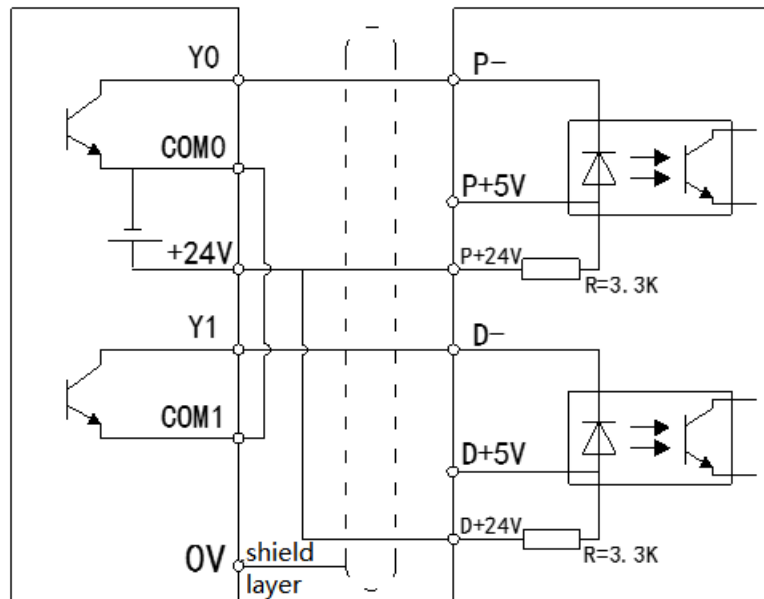

Note: Please suspend P+5V and D+5V.

Detailed hardware wiring diagram refers to XD/XL Series Programmable Controller hardware User Manual.

**1-4-1. Composition of Connecting Equipment**

- XD2, XD3, XD5, XDC series PLC

**XD2, XD3, XD5, XDC (Except for some models) series**

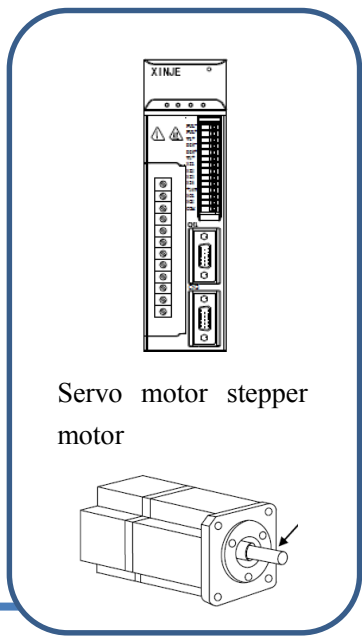
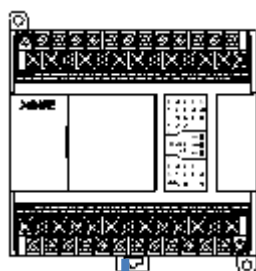

**Transistor output (Y0, Y1)**

※:Two-axis servo motor or stepping motor can be controlled.

● **XD5, XDM, XD5E, XDME series PLC**

**XD5 series (48T6/60T6 points)**

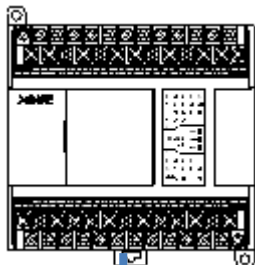

**Transistor output (Y0, Y1, Y2, Y3, Y4, Y5)**

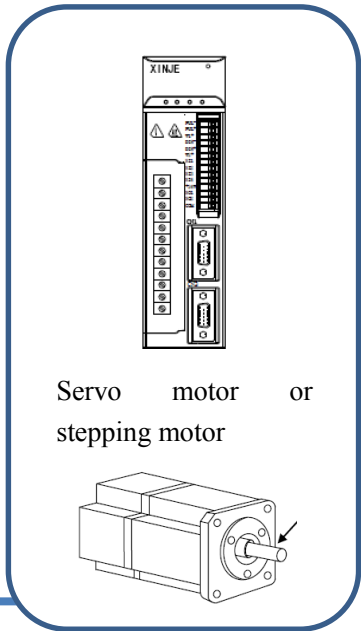

Servo motor or stepping motor

※: Six-axis servo motor or stepping motor can be controlled.

**XD5/XDM series (24T4/32T4) , XDM series (60T4/60T4L) , XD5E-30T4**

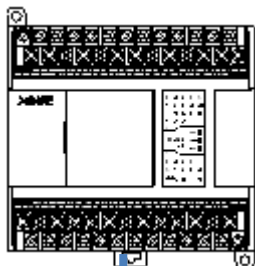

**Transistor output (Y0, Y1, Y2, Y3)**

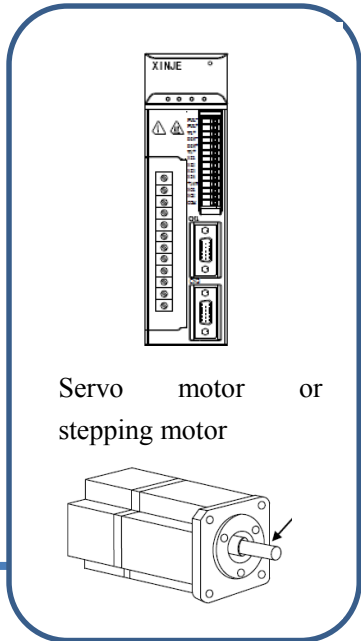

Servo motor or stepping motor

※: Four-axis servo motor or stepping motor can be controlled.



**XDM series (60T10) , XD5E series (60T10), XDME series (60T10)**

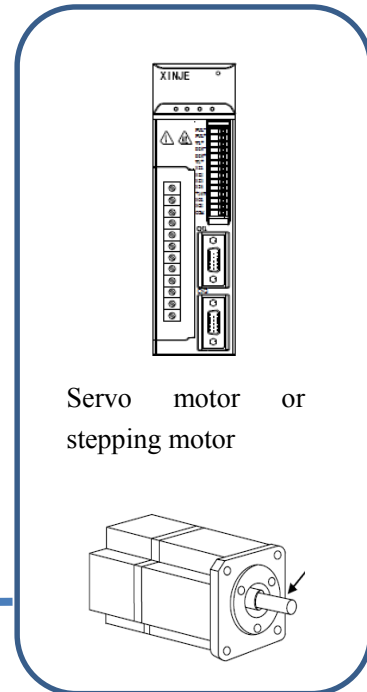

**Transistor output (Y0, Y1, Y2, Y3, Y4, Y5, Y6, Y7, Y10, Y11)**

※: Ten-axis servo motor or stepping motor can be controlled.

● **XDC series PLC**

**XDC series**

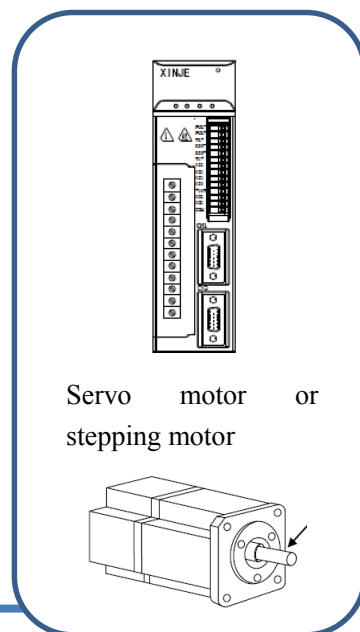
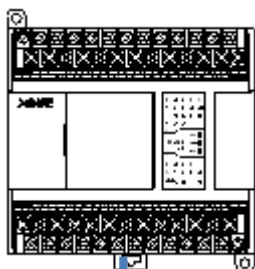

**Transistor output (Y0, Y1)**

※: Two-axis servo motor or stepping motor can be controlled.

● **XL3 series PLC**  
**XL3 series**

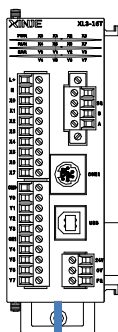

**Transistor output (Y0, Y1)**

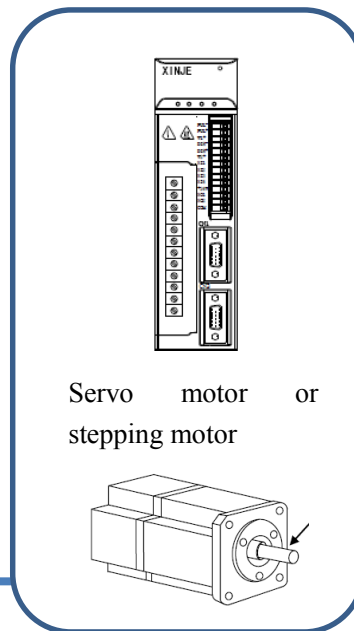

Servo motor or stepping motor

※: Two-axis servo motor or stepping motor can be controlled.

● **XL5, XL5E series PLC**

**XL5, XL5E series**

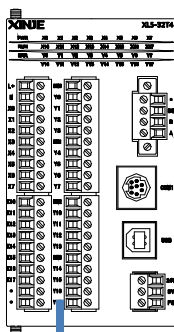

**Transistor output (Y0, Y1, Y2, Y3)**

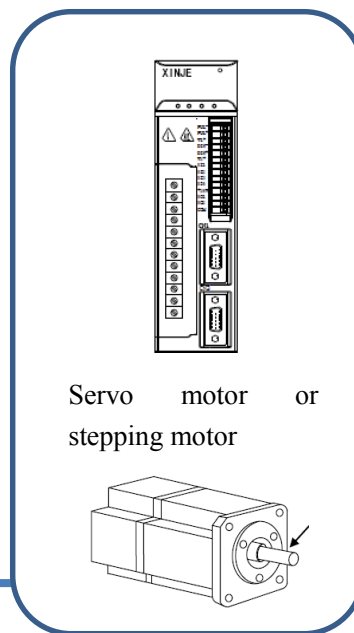

Servo motor or stepping motor

※: 4-axis servo motor or stepping motor can be controlled.

### 1-4-2. Pulse output performance specification

Pulse output performance specification:

Parameter	T/RT	T4	T6	T10	D4T4
Axis number	2	4	6	10	8
Interpolation function	/	XDM/XDME/ XDH/XLME support	/	XDM/XDME support	/
Output mode	Open circuit mode of collector				Open collector, differential
Output form	Pulse + direction				pulse+direction, AB phase
Max frequency	100KHz				Open collector: 100KHz Differential: 920KHz
Acceleration and deceleration treatment	Linear acceleration and deceleration + S curve acceleration and deceleration + sine curve acceleration and deceleration				
Control unit	Pulse, 1mm, 0.1mm, 0.01mm, 1um				
Positioning range	-2147483648~2147483647 (pulse)				
Programming language	Ladder chart				
Manual pulse connection	/	XDM/XDME/ XDH/XLME support	/	XDM/XDME support	/

**Note:**

- (1) All XD/XL series PLC's pulse output must be transistor output type, otherwise it can't send pulse!
- (2) PLC can output high-speed pulses ranging from 100KHz to 200KHz, but it can not guarantee the normal operation of all servos. Please connect 500  $\Omega$  resistance between the output and 24V power supply.

### 1-4-3. Positioning control layout and wiring notes

>>>> Design notes<<<<<



**Danger!**

Please set up a safety circuit outside the programmable controller, so that when there are abnormal external power supply and programmable controller failure, the whole system can also be ensured to operate in a safe state. Misoperation and misoutput may lead to accidents.

1. Make sure to set up emergency stop circuit, protection circuit, interlocking circuit to prevent reverse and positive actions simultaneously, positioning upper and lower limits and other interlocking circuits to prevent mechanical breakage outside the programmable controller.

2. When the programmable controller CPU detects abnormalities through self-diagnostic functions such as watchdog timer, all outputs become OFF. In addition, when abnormalities occur in the input and output control parts which cannot be detected by the programmable controller CPU, the output control sometimes fails.

At this point, please design the external circuit and structure to ensure that the machine is running in a safe state.

3. Because of the faults of relays, transistors, thyristors and so on in the output unit, sometimes the output is always ON or OFF.

In order to ensure the safe operation of machinery, please design the external circuit and structure for the output signal which may lead to major accidents.



**Attention!**

1. The control line should not be tied up with the main circuit or power line, or close to the connection.

In principle, please leave more than 100 mm or away from the main circuit. Otherwise, the noise will cause misoperation.

2. When using, please ensure that the built-in programming interface, power connector, input and output connector are not subject to external forces.

Otherwise, it will lead to disconnection and malfunction.

>>>> Wiring notes <<<<<



**Danger!**

1. When installing, wiring and other operations, be sure to disconnect all external power supply before operation.

Otherwise, there is a risk of electric shock and product damage.

2. After installation, wiring and other operations, when running on power, be sure to install the attached wiring terminal cover on the product.

Otherwise, there is a risk of electric shock.



### Attention !

1. AC power supply wiring should be connected to the special terminals recorded in the basic unit manual.

If AC power supply is connected to DC output input terminal and DC power supply terminal, the programmable controller will be burned down.

2. DC power supply wiring should be connected to the special terminals recorded in the basic unit manual.

If AC power supply is connected to DC output input terminal and DC power supply terminal, the programmable controller will be burned down.

3. Please do not wiring the empty terminals outside.

It may damage the product.

4. Grounding terminals of basic units of XD/XL series should be D grounded with wires over 2 mm<sup>2</sup> (grounding resistance below 100Ω).

However, do not grounding with strong current (refer to XD/XL Series Programmable Controller hardware User Manual).

5. When processing bolt holes and wiring operations, do not drop chips and wire chips into the ventilation holes of the programmable controller.

Otherwise, it may lead to fire, malfunction and misoperation.

6. When using, make sure that the input and output connectors are not subject to external forces.

Otherwise, it will lead to disconnection and malfunction.

7. The input and output cables should be firmly mounted on the specified connectors.

Poor contact can lead to erroneous movements.

8. When wiring the basic units of XD/XL series and terminal of XD/XL series extension equipment, please follow the following precautions.

Otherwise, it may lead to electric shock, fault, short circuit, wire breakage, misoperation and damage to the product.

- Please process the end of the wire according to the size recorded in the manual.

Tightening torque, please follow the torque recorded in the manual.

### >>>>> Cautions in Starting and Maintenance <<<<<



### Danger !

1. Do not touch the terminal when electrifying.

Otherwise, there is the danger of electric shock, and it may cause misoperation.

2. When cleaning and tightening terminals, be sure to operate after disconnecting all external

power supply.

If operated in the state of electrification, there is a danger of electric shock.

3. In order to change procedures, perform mandatory output, RUN, STOP and other operations during operation, you must read the manual well before you can operate it with full confirmation of safety.

Operational errors may lead to mechanical damage and accidents.



### Attention!

1. Do not disassemble or alter products without authorization.

Otherwise, it may cause malfunction, misoperation and fire.

2. When disassembling and assembling connecting cables such as extended cables, please operate after disconnecting the power supply.

Otherwise, it may cause malfunction and misoperation.

3. Be sure to cut off the power supply when disassembling and assembling the following equipment.

Otherwise, it may cause malfunction and misoperation.

--Peripheral devices, extended function boards, special adapters,

--Input and Output Extension Module, Network Module, etc.

## 1-4-4. Setting of Servo Amplifier (Driving Unit) Side

### Pulse Output Form of Programmable Controller Side

The pulse output types of XD/XL series PLC are all collector open circuit signals (pulse + direction), as shown in the following figure:

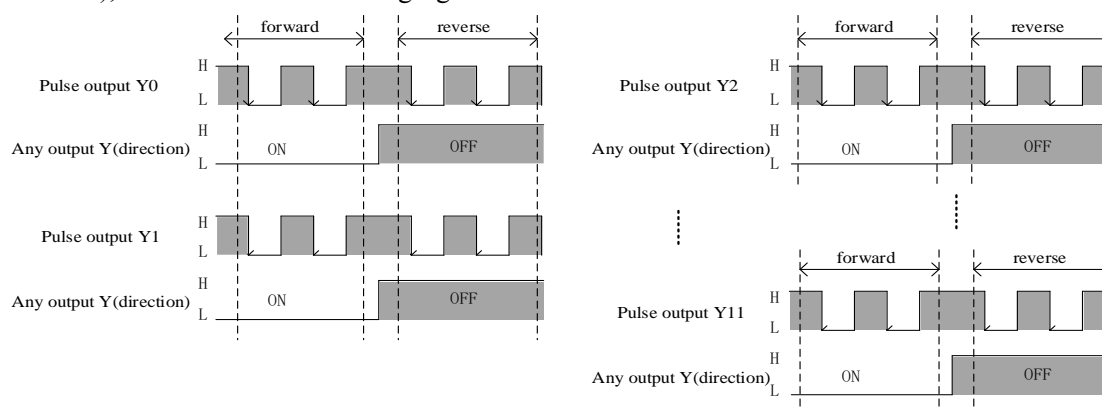

Note: ON and OFF represent the output state of the programmable controller; H and L represent the waveform of HIGH and LOW.

### ● Setting of Instruction Pulse Input Form for Servo Amplifier (Driving Unit)

As shown in the table below, please make the input form of the pulse in the parameters of servo

amplifier (driving unit) coincide with the output form of the programmable controller.

servo amplifier (driving unit)	Pulse output form of basic unit	Collector convert to differential DC-Diff
	Transistor output (Leakage output)	Differential drive
	Pulse + direction	Forward and reverse pulses
Instruction pulse input form	Pulse + sign	Forward and reverse pulses
Instruction pulse logic	Negative logic	Negative logic

Note: The main pulse output form of XD/XL series PLC is collector open-circuit signal output (pulse + direction). The collector open-circuit signal output (pulse + direction) can be converted into differential signal output through collector-to-differential expansion board DC-Diff.

**Wiring diagram of the open collector signal (pulse + direction) converted into differential signal by DC-Diff (taking DS2-21P5-A as an example):**

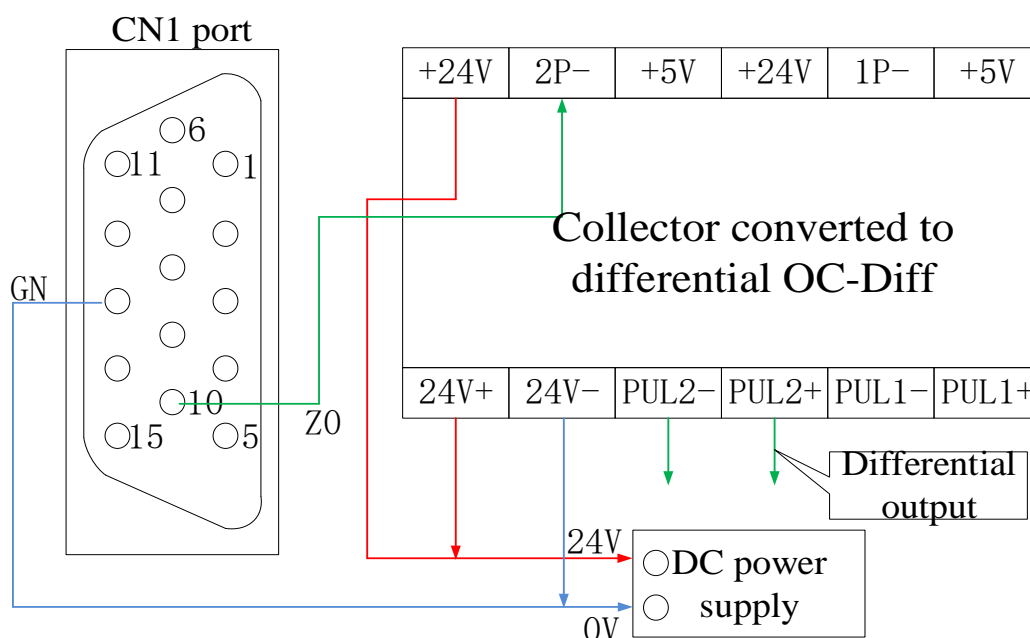

**DS series servo driver parameter settings:**

Series	Parameter	Settings	
		Pulse+direction (negative logic)	Differential signal (negative logic)
DS2-AS	—	√	—
DS2-AS2	—	√	—
DS2-AS6	P2-00	2	1
DS2-BS	—	√	—
DS2-BS6	P2-00	2	1
DS2-BSW	—	√	—
DS2-BSW6	P2-00	2	1
DS3-PQA	P2-00	2	1

DS3E-PFA	P2-00	2	1
DS3 series	P0-10	2	1
DS3E series	P0-10	2	1

● **Electronic Gear Ratio of Servo Amplifier (Driving Unit) (Taking DS2 Series as an Example)**

By using the electronic gear of the servo motor, the movement of each pulse can be set. For the setting of electronic gears, please refer to the manual of servo driver, set values that are consistent with the use.

**Example 1**

The movement of each pulse is set to 10 μ m (when using mechanical screw).

**Mechanical specifications**

Servo driver	DS2 series
Rated Speed of Servo Motor	3000r/min
Ball screw lead pitch (Pb)	10mm
Reduction ratio of reducer (n)	1: 5
Resolution of servo motor (Pt)	10000PLS/REV

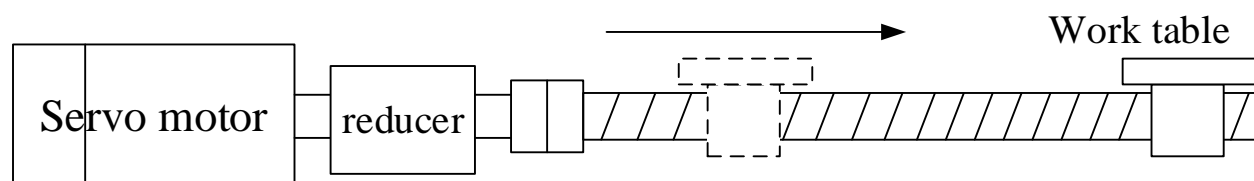

f0: Instruction pulse frequency      NR: Servo motor speed r/min  
 CMX: Electronic gear/numerator      X: Movement per pulse mm  
 CDV: Electronic gear/denominator

The formula for calculating the ratio of electronic gears is as follows:

$$\frac{CMX}{CDV} = X \times \frac{Pt}{n \times Pb} = 10 \times 10^{-3} \times \frac{10000}{1/5 \times 10} = \frac{50}{1}$$

As can be seen from the figure above, the ratio of electronic gear of servo driver should be set to 50:1.

At this time, the rotation speed of the servo motor at the maximum output pulse frequency (200,000 Hz) of the basic unit is calculated as follows:

$$\begin{aligned} NR &= \frac{CMX}{CDV} \times \frac{60}{Pt} \times f_0 \\ &= \frac{50}{1} \times \frac{60}{10000} \times 200000 \\ &= 6000 \text{ r/min} > 3000 \text{ r/min (Rated speed)} \end{aligned}$$



**Note: Please set the maximum speed on the side of the programmable controller so that the rotation speed of the servo motor can be controlled below the rated speed.**

### Example 2

The movement of each pulse is set to 0.01 degree (turntable).

#### Mechanical specifications

Servo driver	DS2 series
Servo motor rated speed	3000r/min
Turn table angle	360°/ REV
Reduction ratio (n)	1: 5
Servo motor resolution (Pt)	10000PLS/REV

Servo motor

Pt=10000[PLS/REV]

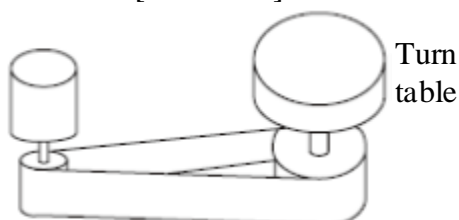

Synchronous belt: 1:5

F0 : Instruction pulse frequency[Hz]

(Collector open circuit)

CMX: Electronic gear (Instruction Pulse Multiplier numerator)

CDV: Electronic gear (Instruction Pulse Multiplier denominator)

NR : Servo motor speed [r/min]

X : Movement per pulse[ °]

The formula for calculating the ratio of electronic gears is as follows:

$$\frac{CMX}{CDV} = X \times \frac{Pt}{n \times 360} = 1 \times 10^{-2} \times \frac{10000}{1/5 \times 360} = \frac{25}{18}$$

As can be seen from the figure above, the ratio of electronic gear of servo driver should be set to 25:1.

At this time, the rotation speed of the servo motor at the maximum output pulse frequency (200,000 Hz) of the basic unit is calculated as follows:

$$\begin{aligned}
 NR &= \frac{CMX}{CDV} \times \frac{60}{Pt} \times f_0 \\
 &= \frac{25}{18} \times \frac{60}{10000} \times 100000 \\
 &= 833.33 \text{r/min} < 3000 \text{r/min (Rated speed)}
 \end{aligned}$$

Because the rotating speed of the servo motor is below the rated speed, the maximum speed of the programmable controller side does not need to be limited.

- **Ready signal of servo driver (take DS2 as an example)**

DS2 series servo enabling signal effectively represents the electrification of the servo motor. When the servo enabling signal is invalid, the motor does not operate.

Series name	Parameter	Setting value
DS2 series	P5-10	0010

#### 1-4-5. Pulse sending complete flag notes

When the pulse sending flag SM1000, SM1020, SM1040 are changed from ON to OFF, it means that the action of instruction (pulse output action, etc.) is over. However, it does not mean that the action of the servo motor is over. In order to accurately grasp the end of the servo motor's operation, please correctly use the pulse sending flag.

Pulse sending flag:

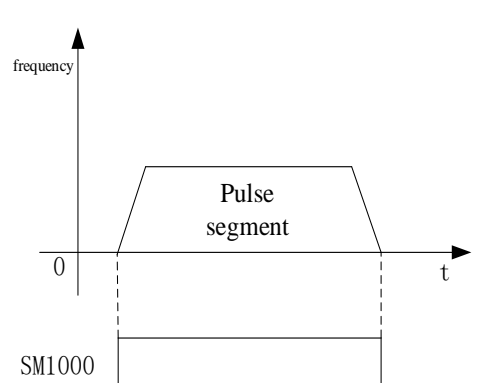
Flag	Axis	Explanation
SM1000	PULSE_1	When the pulse is sending, the coil is ON, and the OFF is set immediately after the pulse is sent. The falling edge of the coil is used to judge whether the pulse is sent or not. 
SM1020	PULSE_2	
SM1040	PULSE_3	
SM1060	PULSE_4	
SM1080	PULSE_5	
SM1100	PULSE_6	
SM1120	PULSE_7	
SM1140	PULSE_8	
SM1160	PULSE_9	
SM1180	PULSE_10	

If multiple positioning instructions for the same pulse output port are written, then when the instructions are executed, the pulse flag SM1000, SM1020, SM1040 will change between ON and OFF as each instructions. Therefore, if multiple instructions are executed, the sending pulse flag SM1000, SM1020, SM1040... are used in the same program at the same time, it is impossible to judge which instruction is executed, and at the same time, it is impossible to obtain the flag supported by each instruction.

Wrong writing is as below:

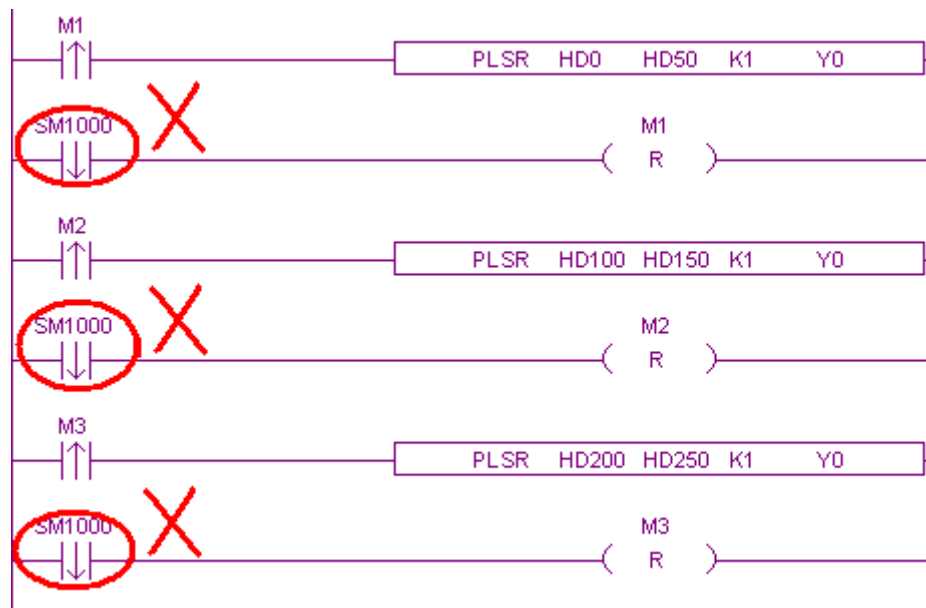

Correct writing is as below:

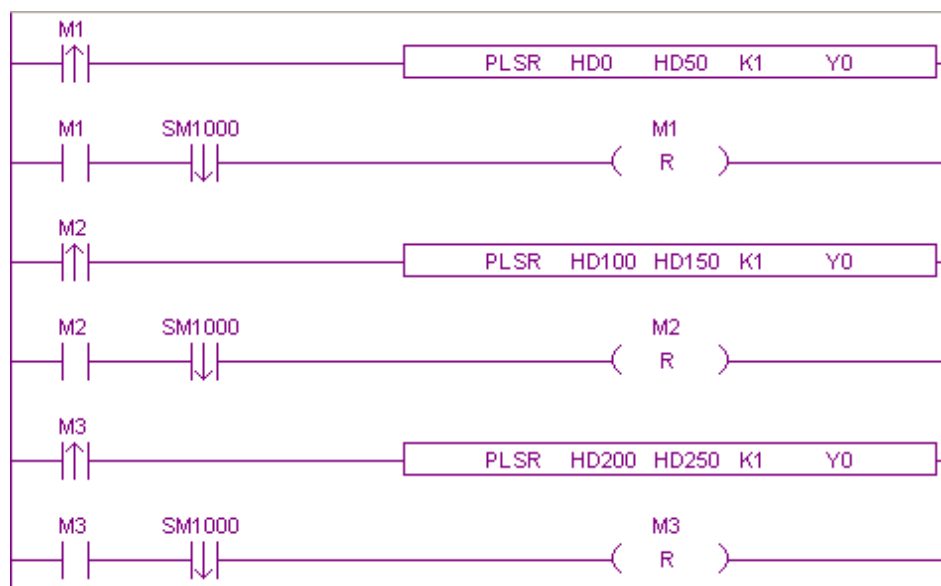

#### 1-4-6. Cautions for triggering conditions of positioning instructions

XD/XL series of PLC positioning instructions are mainly PLSR (edge trigger), PLSF (normal open/close trigger), DRVI (edge trigger), DRVA (edge trigger), ZRN (edge trigger). Except PLSF instruction, all the other pulse instructions are edge trigger. In the process of executing a positioning instruction, the same pulse output port (such as Y0) is sending pulse, flag bit (SM1000) is always ON. The PLC will not respond to the pulse instruction triggered at the same pulse output port until the pulse output instructions being executed are sent out and the signal bit being sent is reset.

Since the conduction condition of PLSF pulse instruction is normally open/closed, when PLSF instruction is used, the conduction condition of PLSF instruction should be reset immediately when the pulse does not need to be executed (do not only set the pulse output frequency to 0 Hz, but not reset the pulse conduction condition).

#### 1-4-7. Positioning Instruction and System Parameter Block Related Parameters

The following table sorts out the parameters setting of pulse output instruction and system parameter block:

System parameter	PLSR	PLSF	DRVI	DRVA	ZRN
Common parameter—pulse direction logic	<b>Must set</b>	<b>Must set</b>	×	×	<b>Must set</b>
Common parameter—enable soft limit	May not set	May not set	×	×	May not set
Common parameter — Default direction of mechanical return to origin	×	×	×	×	<b>Must set</b>
Common parameter —pulse unit	<b>Must set</b>	<b>Must set</b>	×	×	<b>Must set</b>
Common parameter — Interpolated coordinate mode	×	×	×	×	×
Common parameter — pulse send mode	<b>Must set</b>	<b>Must set</b>	×	×	<b>Must set</b>
Common parameter — pulse number(1 rotation)	May not set	May not set	×	×	May not set
Common parameter — offset(1 rotation)	May not set	May not set	×	×	May not set
Common parameter —pulse direction terminal	May not set	May not set	×	×	<b>Must set</b>
Common parameter —delay time of pulse direction	May not set	May not set	×	×	May not set
Common parameter —gear clearance positive compensation	May not set	May not set	×	×	May not set
Common parameter —gear clearance	May not set	May not set	×	×	May not set

negative compensation	set	set			set
Common parameter —electric origin position	×	×	×	×	×
Common parameter —origin switch state setting	×	×	×	×	<b>Must set</b>
Common parameter —origin signal terminal setting	×	×	×	×	<b>Must set</b>
Common parameter —Z phase switch state setting	×	×	×	×	May not set
Common parameter — Z phase terminal setting	×	×	×	×	May not set
Common parameter —positive limit switch status setting	May not set	May not set	×	×	<b>Must set</b>
Common parameter —positive limit terminal setting	May not set	May not set	×	×	<b>Must set</b>
Common parameter —negative limit switch status setting	May not set	May not set	×	×	<b>Must set</b>
Common parameter —negative limit terminal setting	May not set	May not set	×	×	<b>Must set</b>
Common parameter —zero clear CLR signal output terminal setting	×	×	×	×	May not set
Common parameter —return speed VL	×	×	×	×	<b>Must set</b>
Common parameter —creeping speed VC	×	×	×	×	<b>Must set</b>
Common parameter — mechanical zero position	×	×	×	×	<b>Must set</b>
Common parameter — Z phase number	×	×	×	×	May not set
Common parameter — CLR signal delay time	×	×	×	×	May not set
Common parameter —grinding wheel radius(polar coordinate mode)	×	×	×	×	×
Common parameter — soft limit positive limit value					
Common parameter — soft limit negative limit value					
Group 1 parameter — pulse default speed	<b>Must set</b>	<b>Must set</b>	×	×	<b>Must set</b>
Group 1 parameter — acceleration time of pulse default speed	<b>Must set</b>	<b>Must set</b>	×	×	<b>Must set</b>
Group 1 parameter — deceleration time of pulse default speed	<b>Must set</b>	<b>Must set</b>	×	×	<b>Must set</b>

Group 1 parameter — Interval acceleration and deceleration time	May not set	May not set	×	×	May not set
Group 1 parameter —pulse acc/dec mode	<b>Must set</b>	<b>Must set</b>	×	×	<b>Must set</b>
Group 1 parameter —max speed	<b>Must set</b>	<b>Must set</b>	×	×	<b>Must set</b>
Group 1 parameter —start speed	<b>Must set</b>	<b>Must set</b>	×	×	<b>Must set</b>
Group 1 parameter —end speed	<b>Must set</b>	<b>Must set</b>	×	×	<b>Must set</b>

**Note: group 2 to 4 parameters are same to group 1.**

#### 1-4-8. Troubleshooting of Servo Motor and Stepping Motor

When the servo motor and stepper motor do not work, please confirm the following items:

- 1) Please confirm the connection.
- 2) Please execute the positioning instructions to confirm the status of the following LED.

LED set as pulse output signal

LED set as pulse direction signal

- 3) Make sure that when the programmable controller executes the positioning instructions, the values of the accumulated pulse registers of each axis are changing.

The cumulative registers for each pulse output are shown in the following table:

No.	Function	Notes	Axis
HSD0	Low 16-bit of cumulative pulse	Pulse number is the unit	PULSE_1
HSD1	High 16-bit of cumulative pulse		
HSD2	Low 16-bit of cumulative pulse	Pulse equivalent is the unit	
HSD3	High 16-bit of cumulative pulse		
HSD4	Low 16-bit of cumulative pulse	Pulse number is the unit	PULSE_2
HSD5	High 16-bit of cumulative pulse		
HSD6	Low 16-bit of cumulative pulse	Pulse equivalent is the unit	
HSD7	High 16-bit of cumulative pulse		
HSD8	Low 16-bit of cumulative pulse	Pulse number is the unit	PULSE_3
HSD9	High 16-bit of cumulative pulse		
HSD10	Low 16-bit of cumulative pulse	Pulse equivalent is the unit	
HSD11	High 16-bit of cumulative pulse		
HSD12	Low 16-bit of cumulative pulse	Pulse number is the unit	PULSE_4
HSD13	High 16-bit of cumulative pulse		
HSD14	Low 16-bit of cumulative pulse	Pulse equivalent is the unit	
HSD15	High 16-bit of cumulative pulse		
HSD16	Low 16-bit of cumulative pulse	Pulse number is the unit	PULSE_5
HSD17	High 16-bit of cumulative pulse		
HSD18	Low 16-bit of cumulative pulse	Pulse equivalent is the unit	
HSD19	High 16-bit of cumulative pulse		

HSD20	Low 16-bit of cumulative pulse	Pulse number is the unit	PULSE_6
HSD21	High 16-bit of cumulative pulse		
HSD22	Low 16-bit of cumulative pulse	Pulse equivalent is the unit	
HSD23	High 16-bit of cumulative pulse		
HSD24	Low 16-bit of cumulative pulse	Pulse number is the unit	PULSE_7
HSD25	High 16-bit of cumulative pulse		
HSD26	Low 16-bit of cumulative pulse	Pulse equivalent is the unit	
HSD27	High 16-bit of cumulative pulse		
HSD28	Low 16-bit of cumulative pulse	Pulse number is the unit	PULSE_8
HSD29	High 16-bit of cumulative pulse		
HSD30	Low 16-bit of cumulative pulse	Pulse equivalent is the unit	
HSD31	High 16-bit of cumulative pulse		
HSD32	Low 16-bit of cumulative pulse	Pulse number is the unit	PULSE_9
HSD33	High 16-bit of cumulative pulse		
HSD34	Low 16-bit of cumulative pulse	Pulse equivalent is the unit	
HSD35	High 16-bit of cumulative pulse		
HSD36	Low 16-bit of cumulative pulse	Pulse number is the unit	PULSE_10
HSD37	High 16-bit of cumulative pulse		
HSD38	Low 16-bit of cumulative pulse	Pulse equivalent is the unit	
HSD39	High 16-bit of cumulative pulse		

4) Make sure that the pulse output form of the programmable controller side and the servo amplifier (driving unit) is consistent.

5) Make sure that the stop bit of the pulse output is in action.

The pulse output flags of each pulse are shown in the table below.

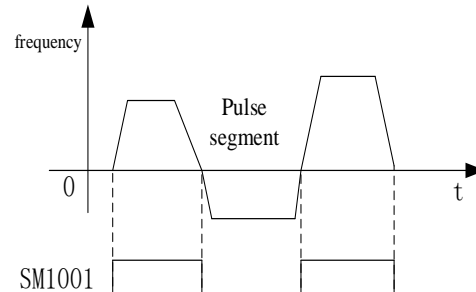
No.	Coil	Axis	Note
1	SM1001	PULSE_1	<p>When the pulse value is positive, the coil is ON; when the pulse value is negative, the coil is OFF.</p> 
2	SM1021	PULSE_2	
3	SM1041	PULSE_3	
4	SM1061	PULSE_4	
5	SM1081	PULSE_5	
6	SM1101	PULSE_6	
7	SM1121	PULSE_7	
8	SM1141	PULSE_8	
9	SM1161	PULSE_9	
10	SM1181	PULSE_10	

6) Please confirm whether the limit (positive limit and reverse limit) is in action.

7) Please confirm the action sequence of positioning instruction.

When the pulse flag bit is ON, the positioning instruction or the pulse output instruction using the

same output terminal can not be executed.

#### 1-4-9. Troubleshooting of incorrect stop position of servo motor and stepper motor

When the stop position is incorrect, please confirm the following items:

- 1) Make sure that the setting of the electronic gear of the servo amplifier (driving unit) is correct.
- 2) Please confirm whether the origin position is offset.

**A. When designing the origin signal, consider that there is enough time for ON to slow down to crawling speed.**

The ZRN instruction begins to decelerate to stop at the front end of the origin, delays and reverse accelerates to crawl speed, stops when it leaves the origin, and clears the current value register.

Failure to slow down to crawl speed in front of the back end of the origin will cause stop position offset.

**B. Please make the crawling speed slow enough.**

The stop of the origin regression instruction is not decelerated, so if the crawling speed is too fast, the stop position will be offset due to inertia.

**C. Soft components for origin signals.**

The origin signal terminal can select all the input points on the PLC; but if the selected input point is the external interrupt terminal on the PLC main unit, the process of returning to the mechanical origin will be handled according to the interrupt, which can further improve the accuracy of returning to the mechanical origin (if Z phase is used to return to the origin, it will not affect); and the selected input point is the external interrupt terminal on PLC extension module, in the process of mechanical origin, it will be affected by the scanning cycle of PLC (if Z phase is used to return to the origin, it will not be affected).

- 3) After the forward and reverse rotation (round-trip action), the stop position deviates.

Because of the contact gap between the worktable and the ball screw, when the worktable switches from the forward movement to the reverse movement, the reverse actual movement distance is less than the set distance; when the worktable switches from the reverse movement to the forward movement, the forward actual movement distance is less than the set distance.

It can be corrected by forward gear clearance compensation and reverse gear clearance compensation.



## 1-5. Positioning instruction example programs

This section mainly introduces the use of PLSR, PLSF, DRVA, DRVI, ZRN instructions through several sample programs.

Action	Instruction	Program example	
		Sequential ladder chart	Process ladder chart
Multi section pulse positioning	PLSR	1-5-4	1-5-5
		1-5-6	1-5-7
Variable frequency pulse output	PLSF	1-5-2	1-5-3
		1-5-4	1-5-5
Relative single section positioning	DRVI	1-5-2	1-5-3
		1-5-6	1-5-7
Absolute single section positioning	DRVA	1-5-2	1-5-3
		1-5-6	1-5-7
Mechanical origin regression	ZRN	1-5-2	1-5-3
		1-5-4	1-5-5
		1-5-6	1-5-7

### 1-5-1. I/O point assignment

The pulse output Y0 (axis 1) is used in the program example. When using other pulse output terminals, please modify the corresponding soft components of the pulse axis.

Signal name	I/O points	Notes
Pulse output port	Y0	
Pulse direction port	Y2	
CLR zero clear signal	Y3	
Servo ready	X0	
Stop	X1	
Pulse continue	X13	
Origin regression	X4	
Jog forward	X5	
Jog reverse	X6	
Forward rotation positioning	X7	
Reverse rotation positioning	X10	
Close origin input terminal	X2	
Origin input terminal	X3	External interruption terminal
Forward limit switch	X11	
Reverse limit switch	X12	

### 1-5-2. Forward and reverse rotation sequence control sample program 【PLSF, DRVI, DRVA, ZRN】

**Example 1:** According to the following figure, use the absolute single section positioning method.

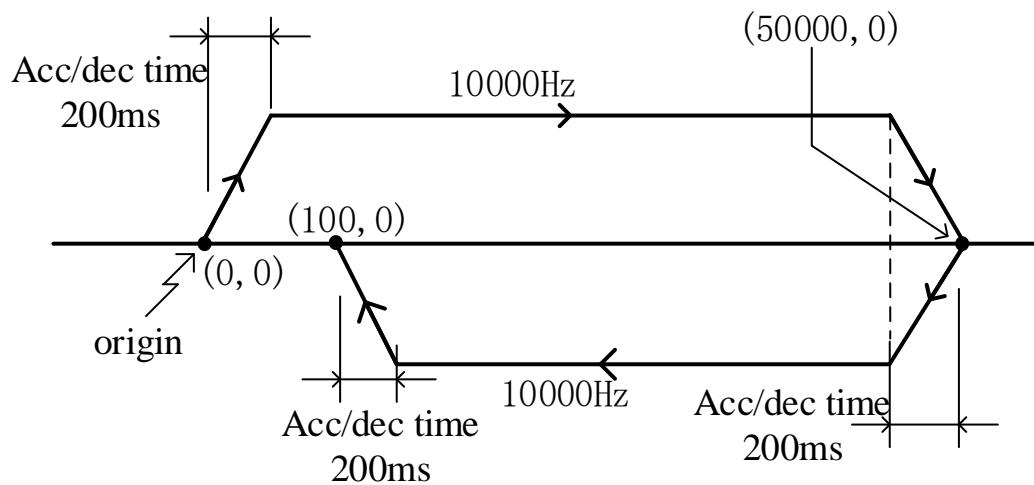

Firstly, the ladder chart program is shown as follows:

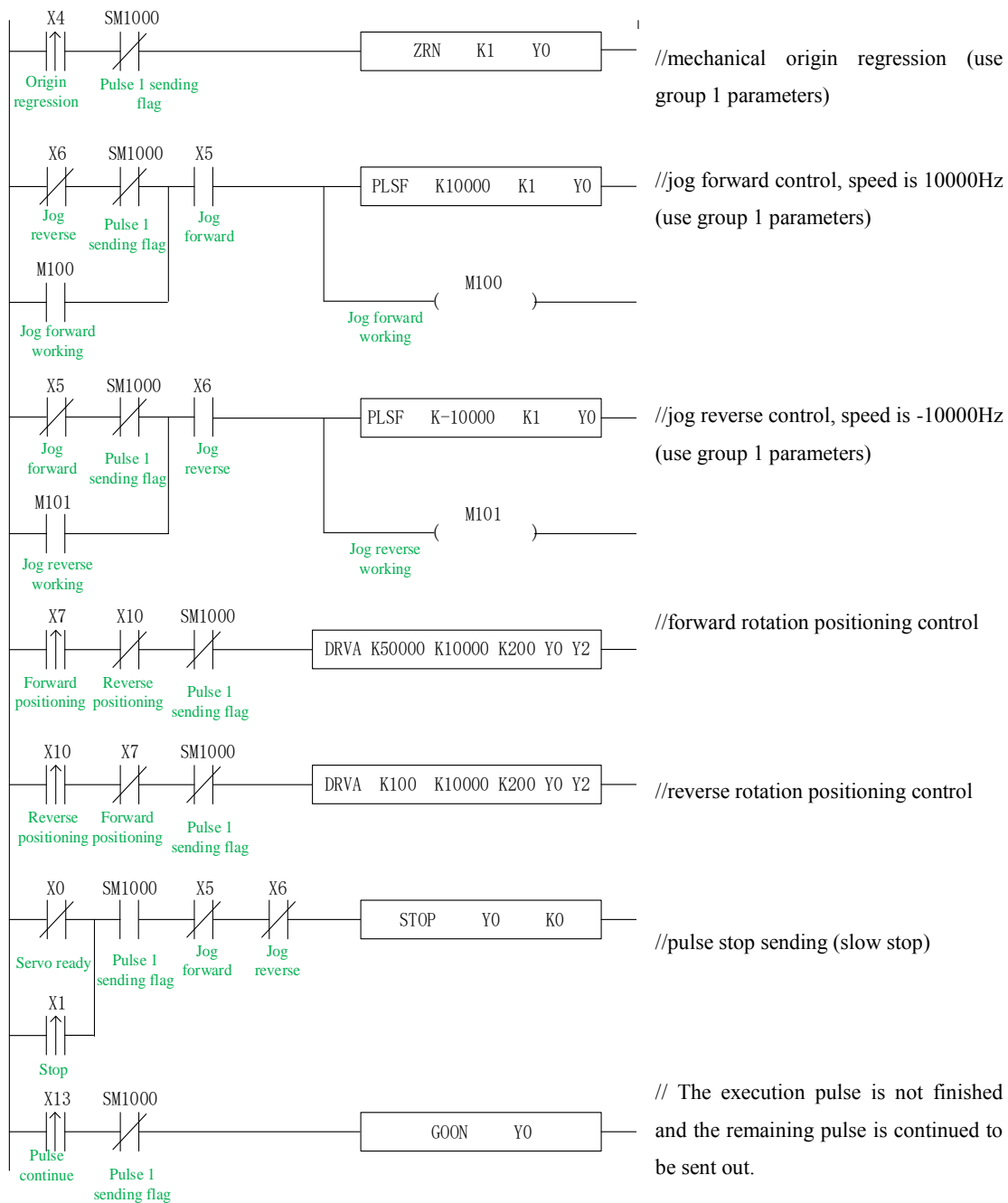

In the sample program, except DRVI and DRVA, all the system parameters used in the pulse instructions are group 1 parameters. So we click the "pulse configuration parameters" in the PLC programming software, as follows:

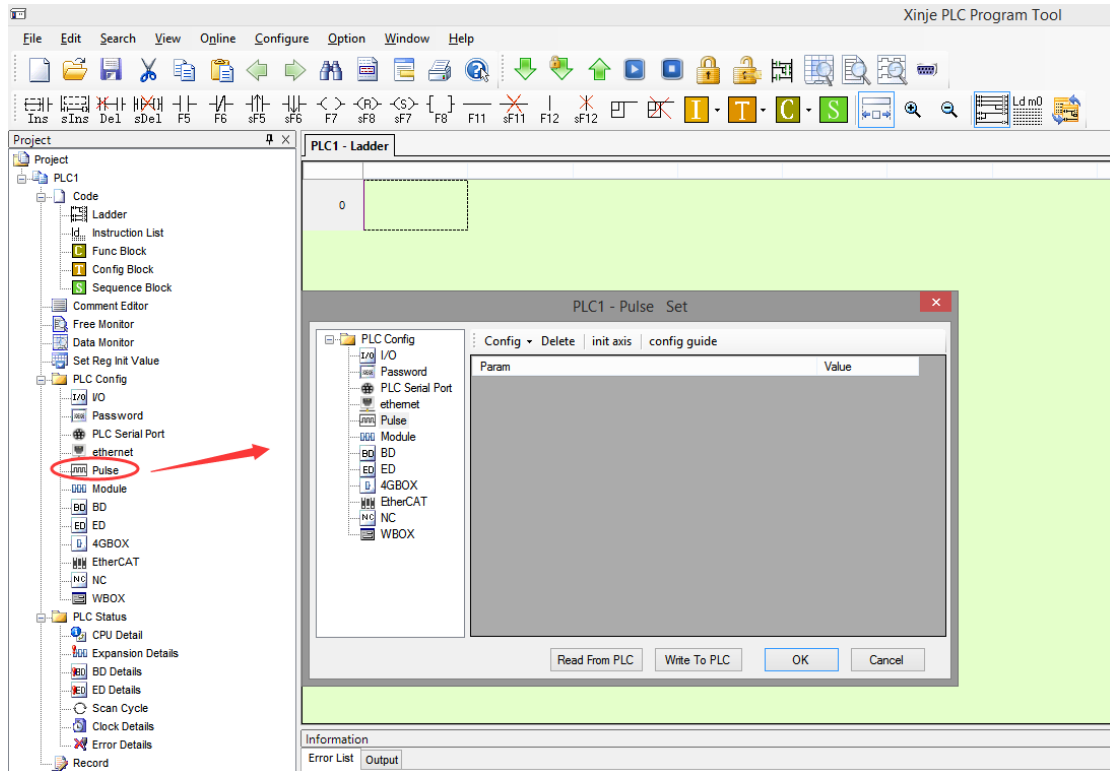

Click config, then select Y0 axis.

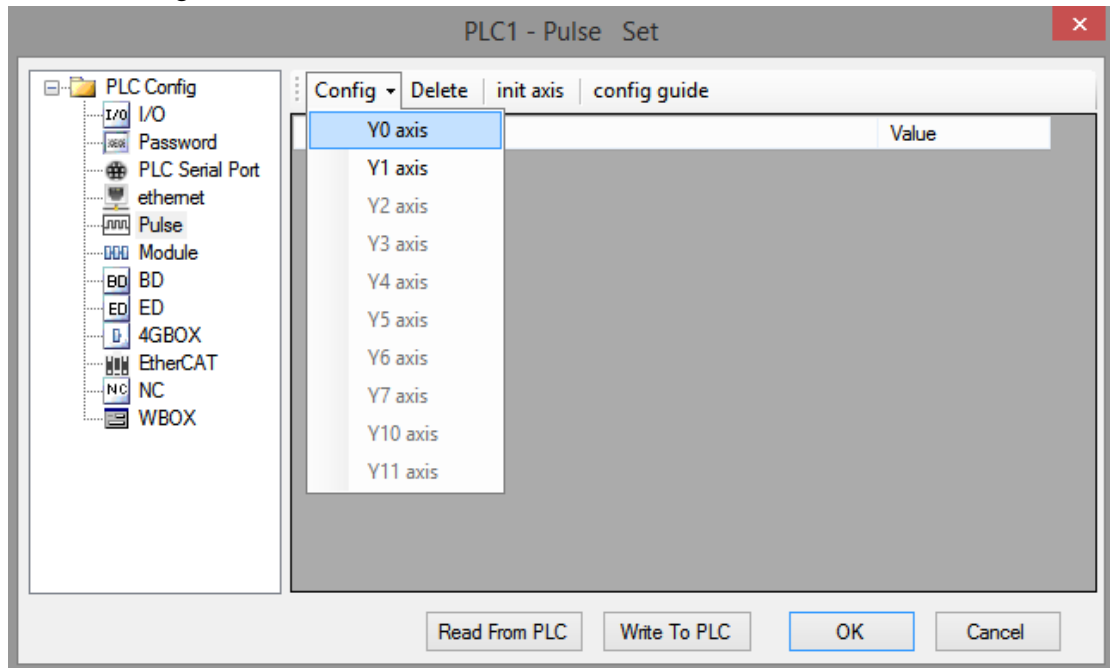

In the parameter configuration table, configure as follows (circled parameters need to be modified):

The image shows two screenshots of the 'PLC1 - Pulse Set' configuration window. The top screenshot displays the 'Param SFD906' table, and the bottom screenshot displays the 'Param SFD915 bit0-bit7' table. In both tables, specific parameters are circled in red to indicate they need to be modified.

**Top Screenshot: Param SFD906**

Param SFD906	Value
YO axis-Common-Parameters setting-Motor operating mo...	Position Mode
YO axis-Common-Parameters setting-Pulse unit	pulse number
YO axis-Common-Parameters setting-Interpolation coor...	Cross coordi...
YO axis-Common-pulse send mode	complete mode
YO axis-Common-Pulse num (1)	1
YO axis-Common-Offset (1)	1
<b>YO axis-Common-Pulse direction terminal</b>	<b>Y2</b>
YO axis-Common-Delayed time of pulse direction (ms)	10
YO axis-Common-Gear clearance positive compensation	0
YO axis-Common-Gear clearance negative compensation	0
YO axis-Common-Electrical origin position	0

**Bottom Screenshot: Param SFD915 bit0-bit7**

Param SFD915 bit0-bit7	Value
YO axis-Common-Delayed time of pulse direction (ms)	10
YO axis-Common-Gear clearance positive compensation	0
YO axis-Common-Gear clearance negative compensation	0
YO axis-Common-Electrical origin position	0
YO axis-Common-signal terminal switch state setting...	normally on
YO axis-Common-signal terminal switch state setting...	normally on
YO axis-Common-signal terminal switch state setting...	normally on
YO axis-Common-signal terminal switch state setting...	normally on
<b>YO axis-Common-Far-point signal terminal setting</b>	<b>X3</b>
YO axis-Common-Z phase terminal setting	X no terminal
<b>YO axis-Common-positive limit terminal setting</b>	<b>X11</b>

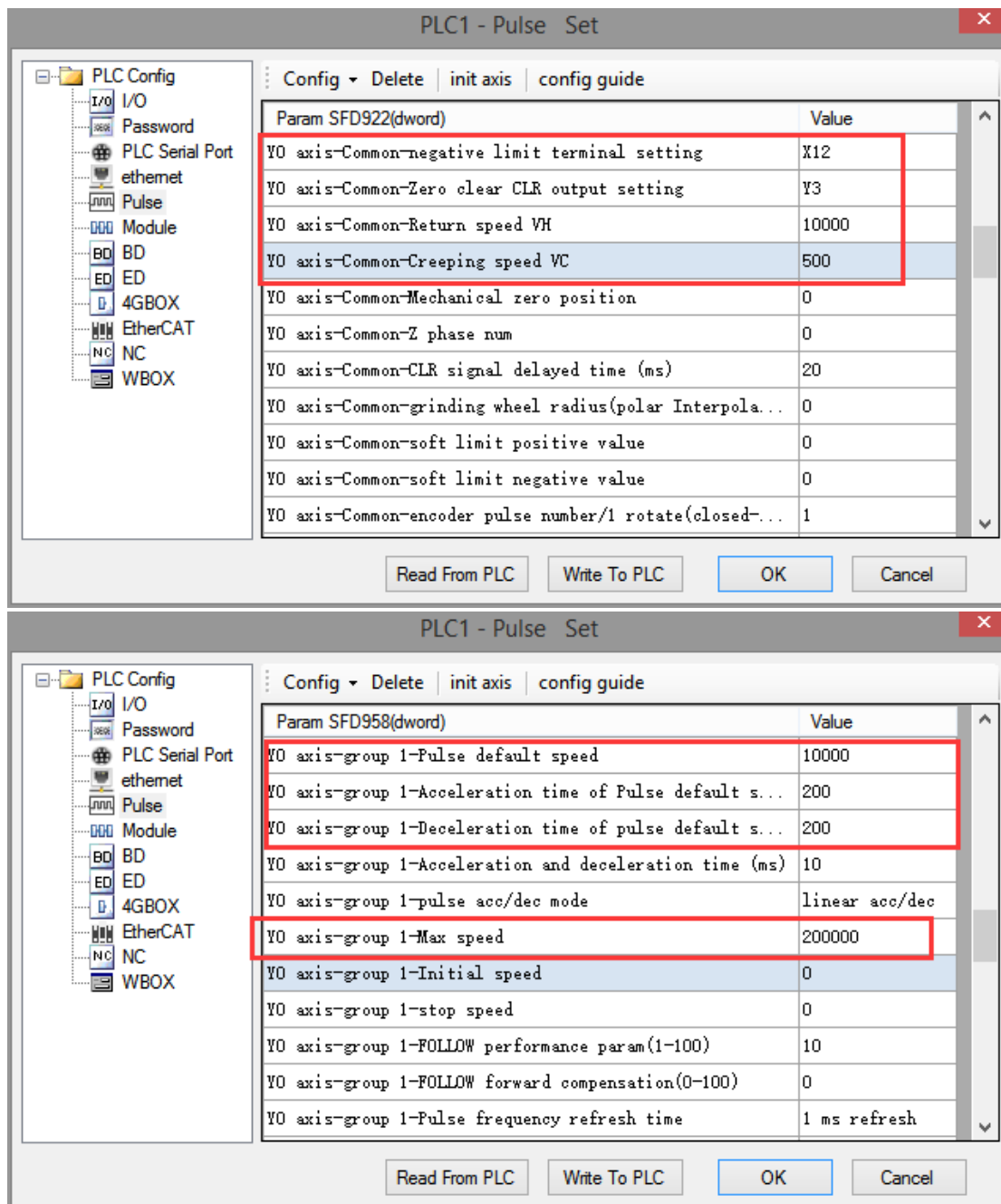

After configuring the parameters, click the "Write to PLC" button to write the parameters into the PLC. After downloading the program, power off the PLC and then power on again.

Positive Limit (X11) and Negative Limit (X12) will play an important role in the execution of ZRN, PLSF, DRVI and DRVA instructions.

**Example 2: According to the following figure, use the relative single segment positioning method.**

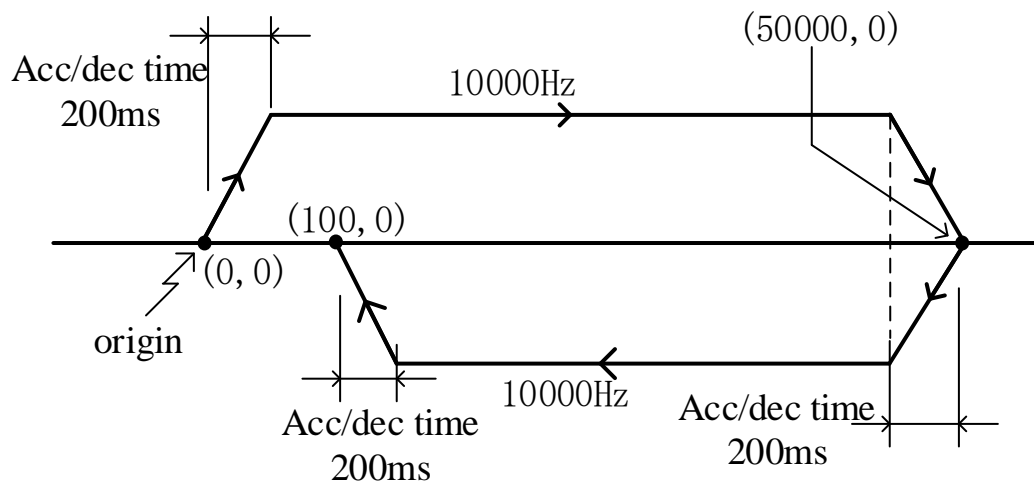

Firstly, make the ladder chart as follows:

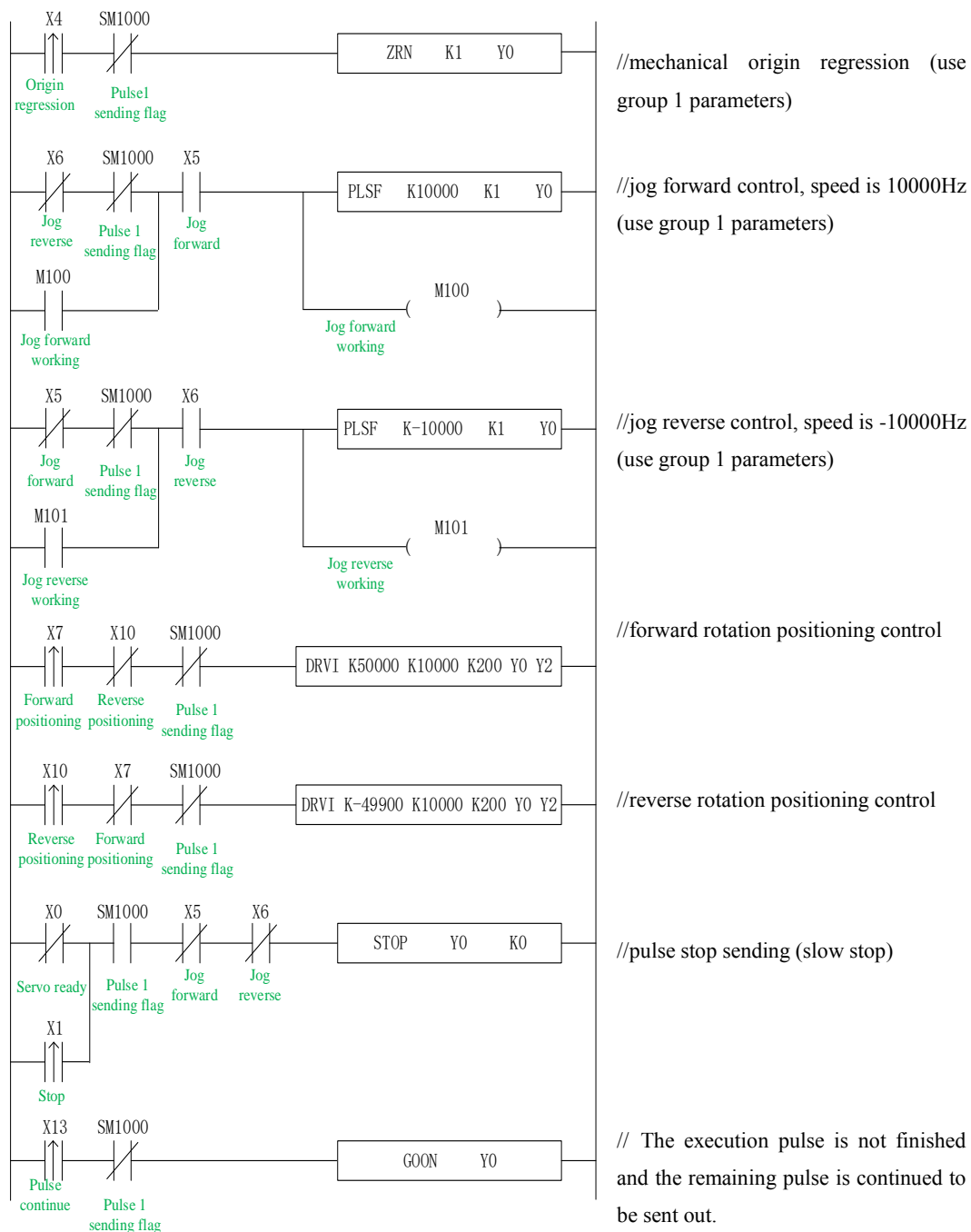

In the sample program, except DRVI and DRVA, all the system parameters used in the pulse instructions are group 1 parameters. So, we click "pulse configuration parameters" in the PLC programming software, as follows:



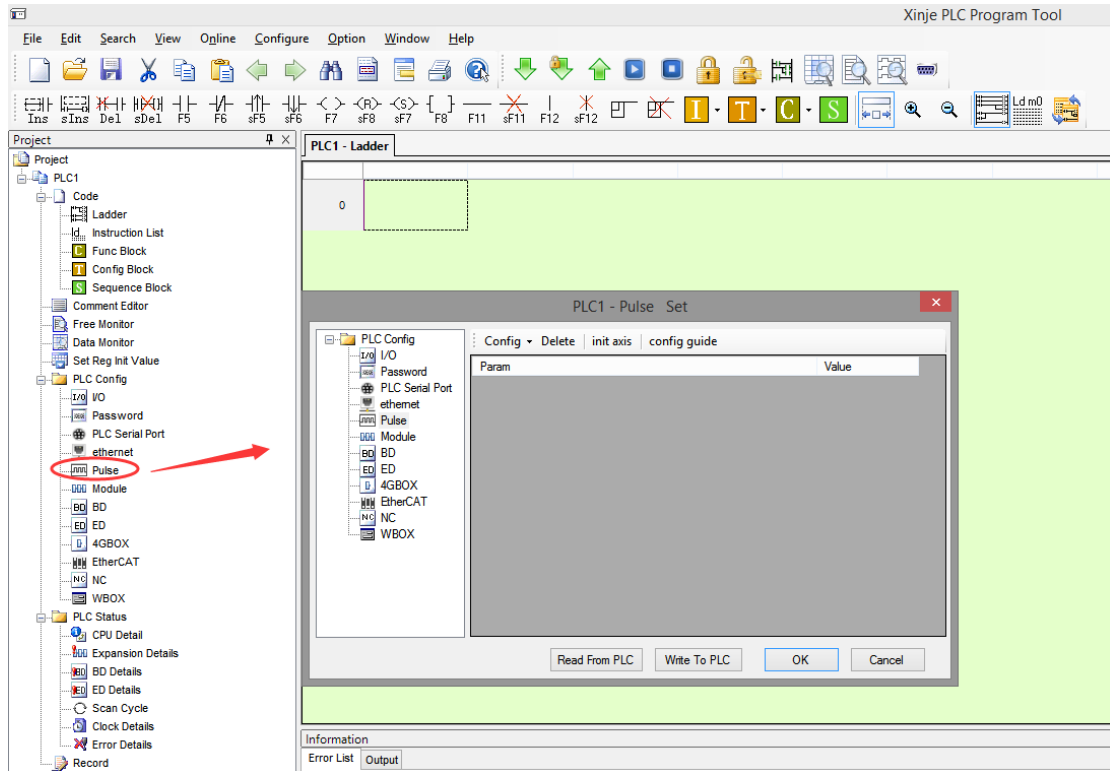

Click config, then select Y0 axis.

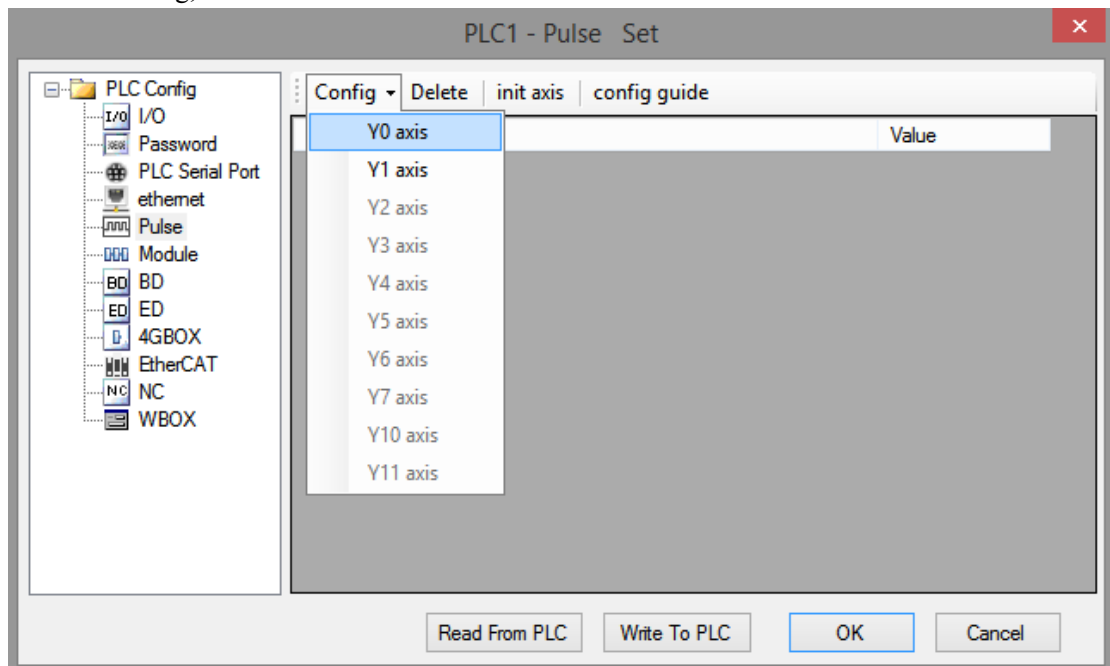

In the parameter configuration table, configure as follows (circled parameters need to be modified):

The image shows two screenshots of the 'PLC1 - Pulse Set' configuration window. The first screenshot displays the 'Param SFD906' table, and the second screenshot displays the 'Param SFD915 bit0-bit7' table. In both tables, specific parameters are circled in red to indicate they need to be modified.

**Param SFD906**

Param SFD906	Value
YO axis-Common-Parameters setting-Motor operating mo...	Position Mode
YO axis-Common-Parameters setting-Pulse unit	pulse number
YO axis-Common-Parameters setting-Interpolation coor...	Cross coordi...
YO axis-Common-pulse send mode	complete mode
YO axis-Common-Pulse num (1)	1
YO axis-Common-Offset (1)	1
<b>YO axis-Common-Pulse direction terminal</b>	<b>Y2</b>
YO axis-Common-Delayed time of pulse direction (ms)	10
YO axis-Common-Gear clearance positive compensation	0
YO axis-Common-Gear clearance negative compensation	0
YO axis-Common-Electrical origin position	0

**Param SFD915 bit0-bit7**

Param SFD915 bit0-bit7	Value
YO axis-Common-Delayed time of pulse direction (ms)	10
YO axis-Common-Gear clearance positive compensation	0
YO axis-Common-Gear clearance negative compensation	0
YO axis-Common-Electrical origin position	0
YO axis-Common-signal terminal switch state setting...	normally on
YO axis-Common-signal terminal switch state setting...	normally on
YO axis-Common-signal terminal switch state setting...	normally on
YO axis-Common-signal terminal switch state setting...	normally on
<b>YO axis-Common-Far-point signal terminal setting</b>	<b>X3</b>
YO axis-Common-Z phase terminal setting	X no terminal
<b>YO axis-Common-positive limit terminal setting</b>	<b>X11</b>

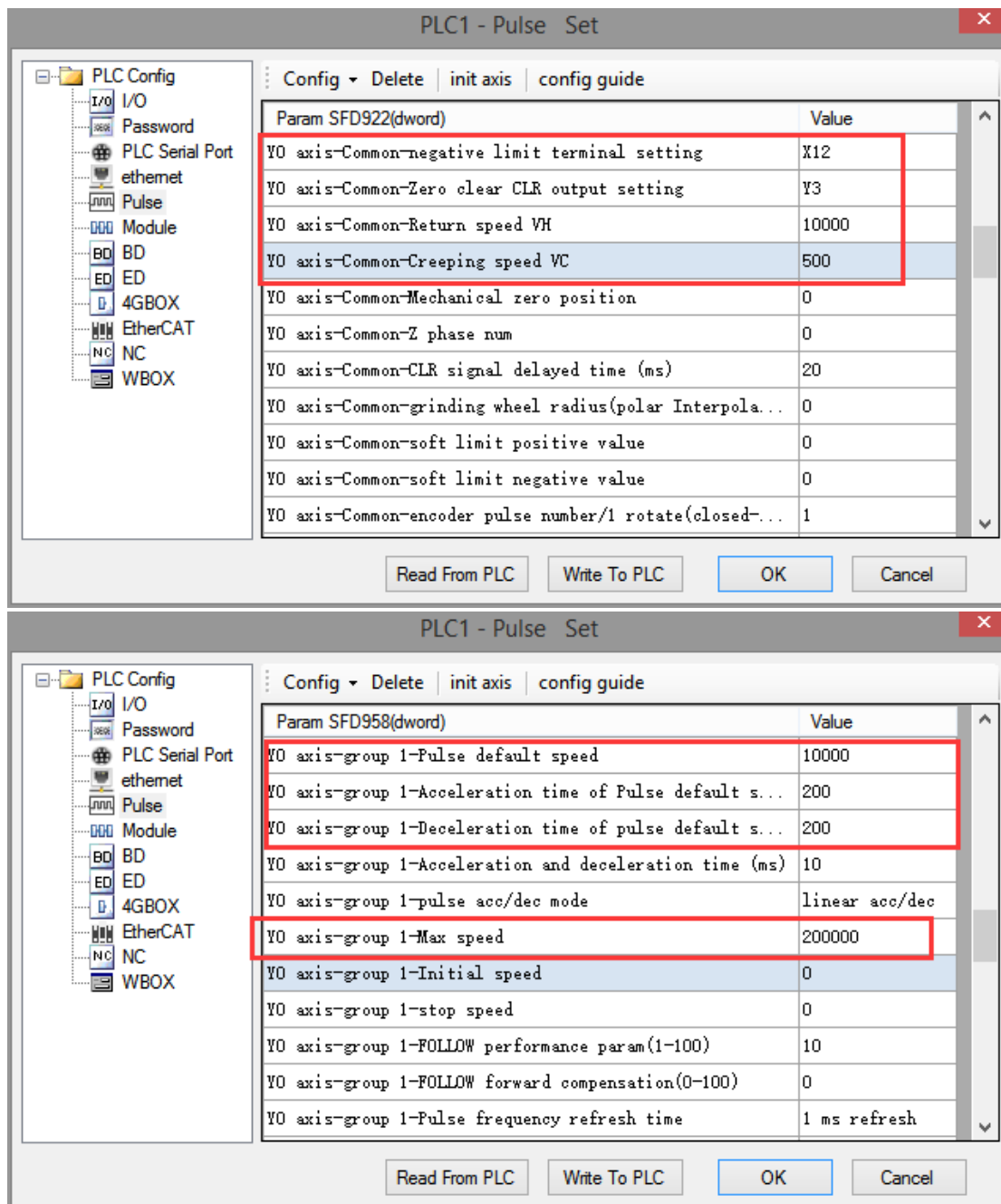

After configuring the parameters, click the "Write to PLC" button to write the parameters into the PLC. After downloading the program, power off the PLC and then power on again.

Positive Limit (X11) and Negative Limit (X12) will play an important role in the execution of ZRN, PLSF, DRVI and DRVA instructions.

**1-5-3. Forward and reverse rotation process program**  
**【PLSE, DRVI, DRVA, ZRN】**

**Example 1: According to the following figure, use the absolute single segment positioning method.**

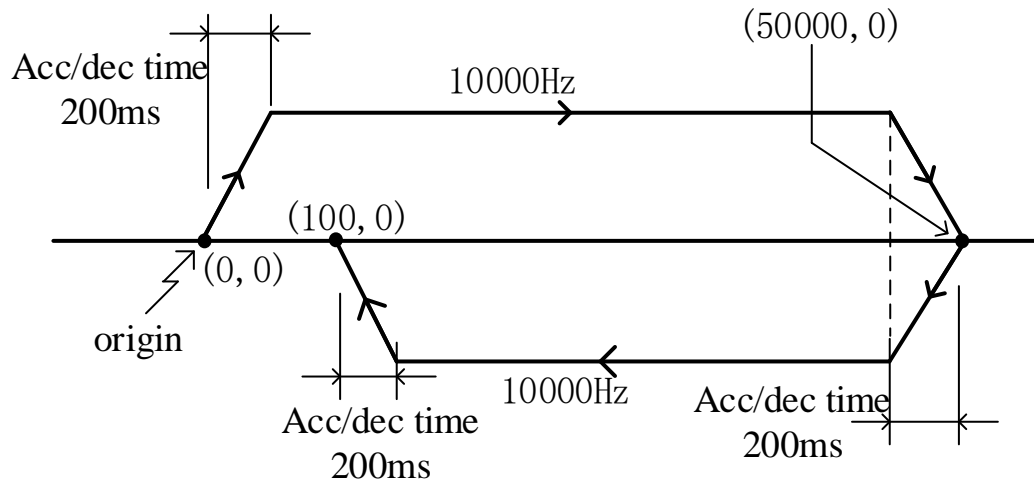

Firstly, make the ladder chart as follows:

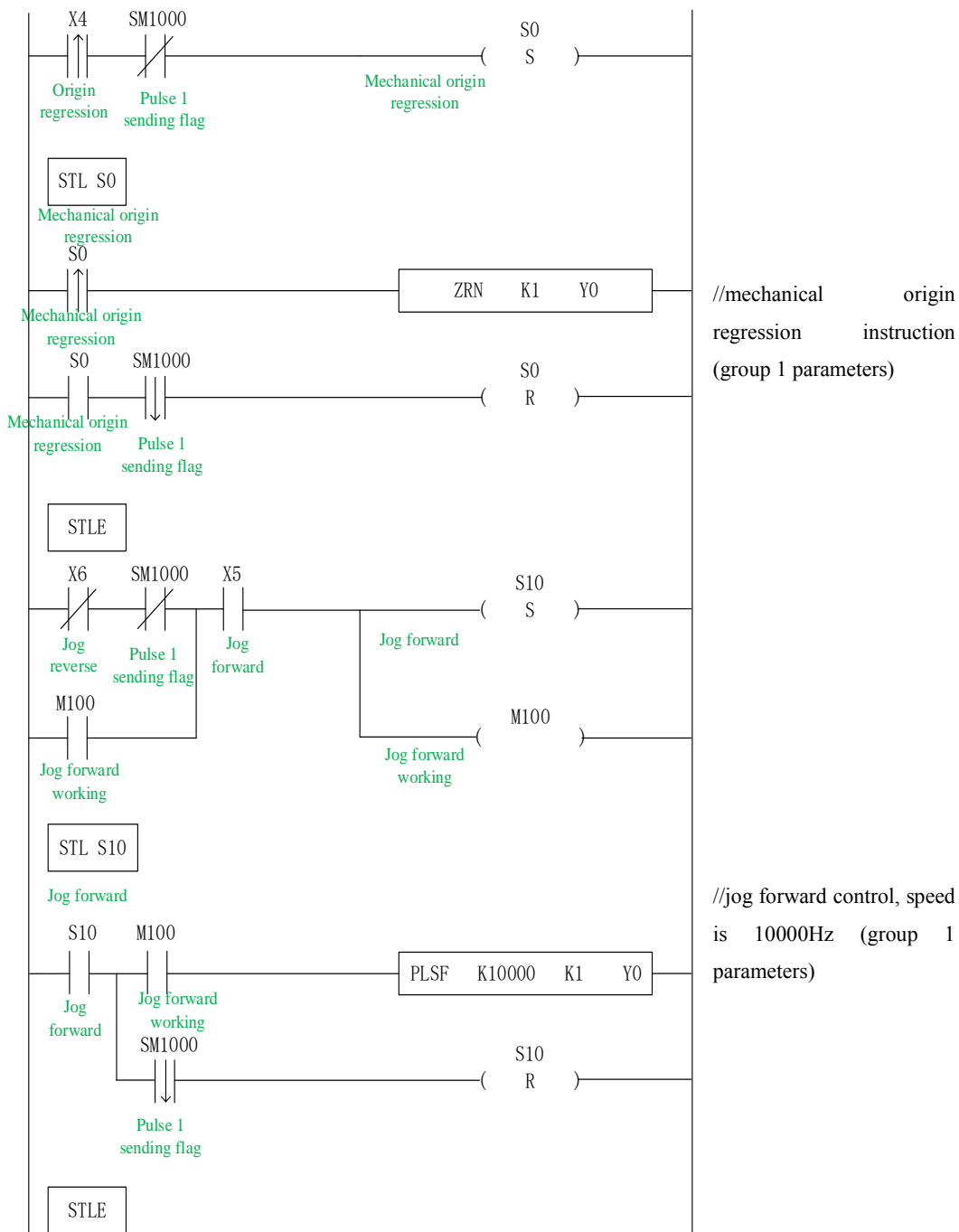

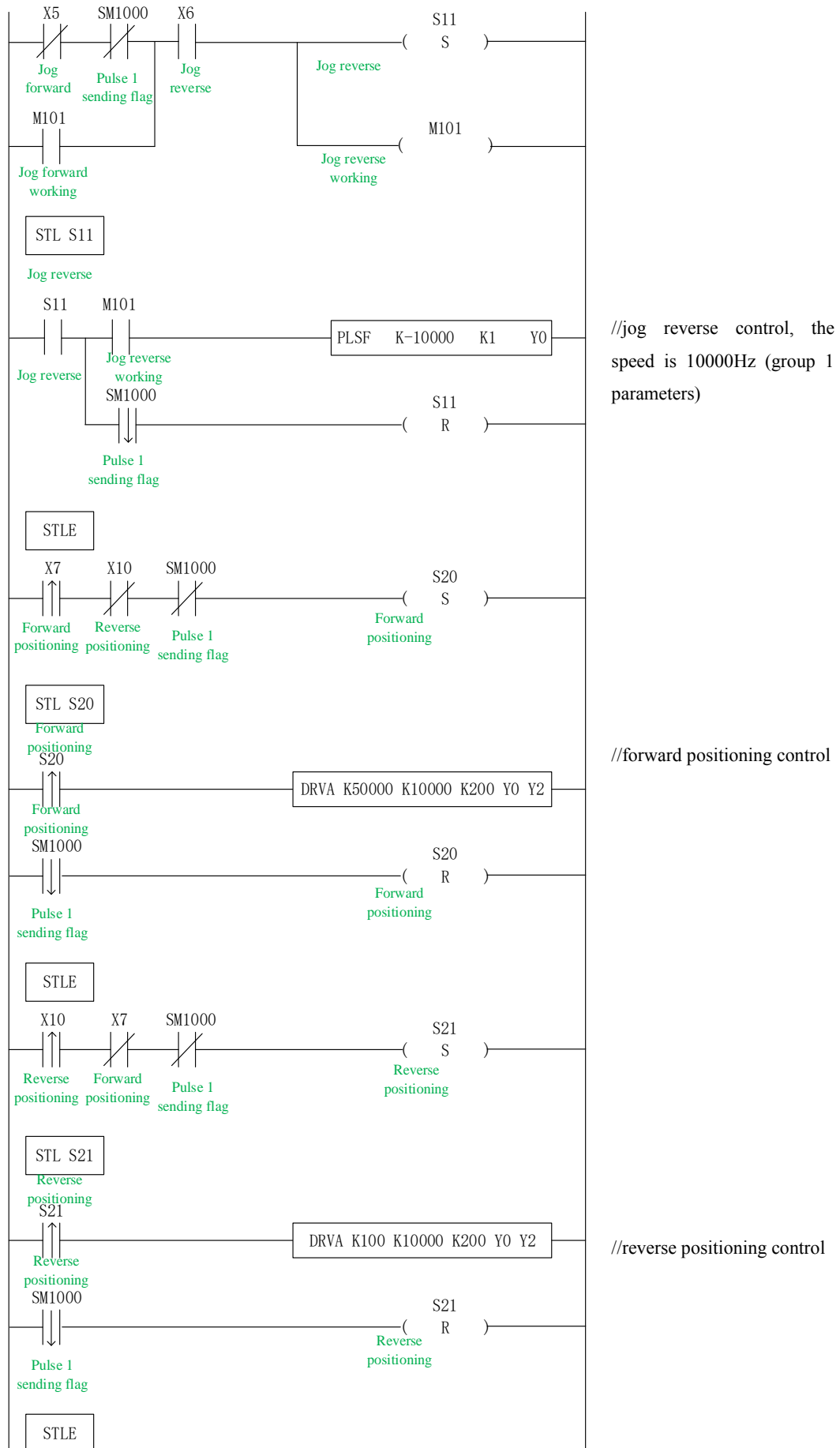

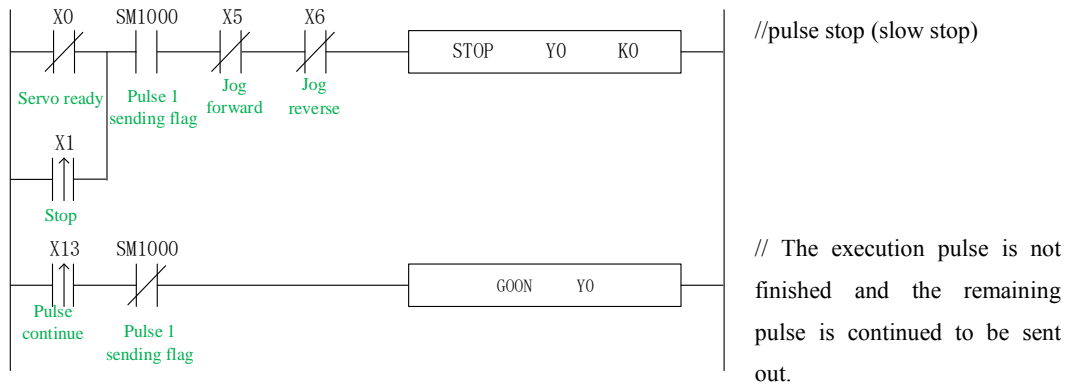

In the sample program, except DRVI and DRVA, all the system parameters used in the pulse instructions are group 1 parameters. So, we click "pulse configuration parameters" in the PLC programming software, as follows:

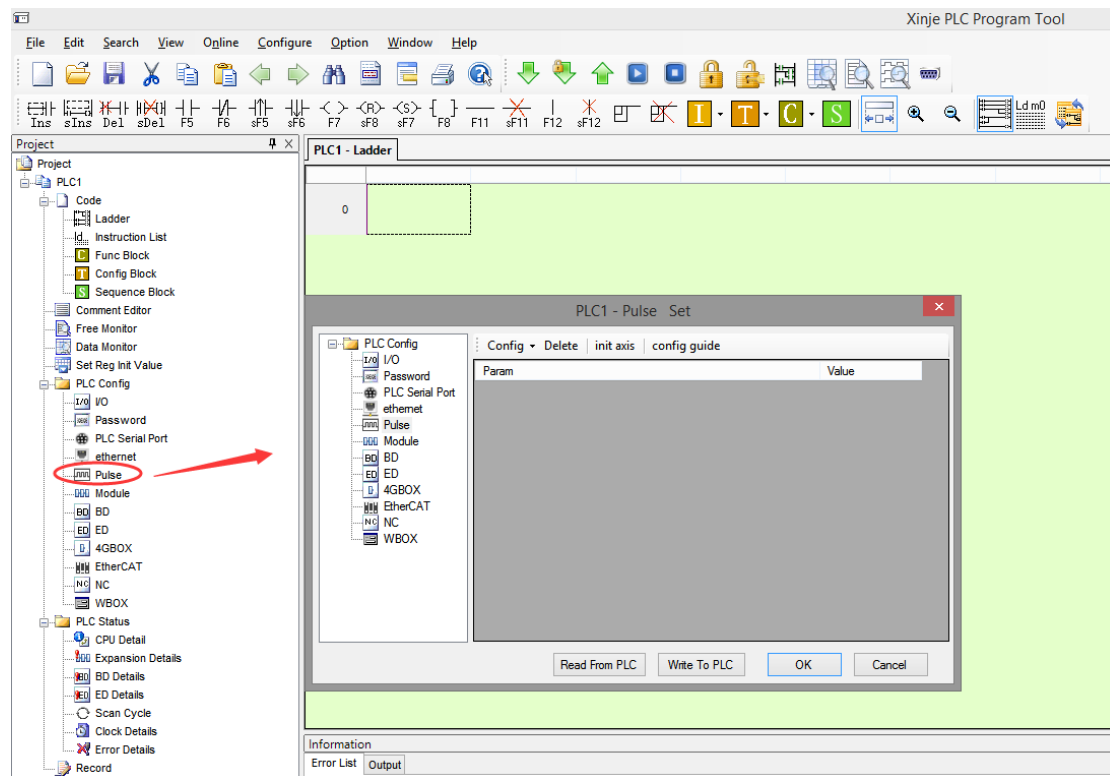

Click config, then select Y0 axis.

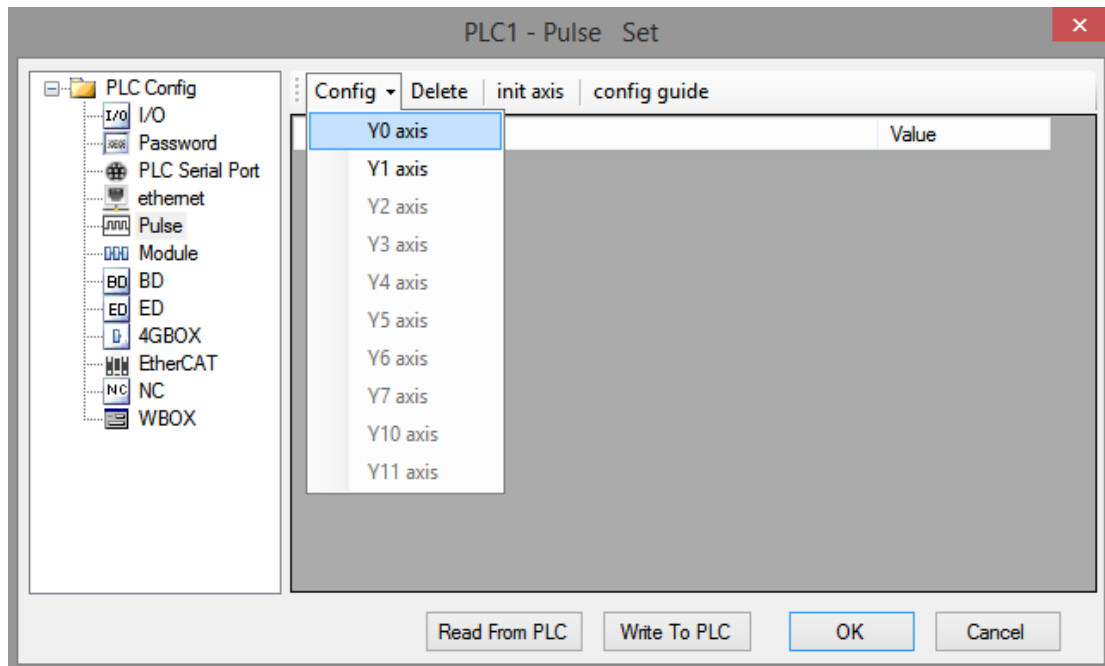

In the parameter configuration table, configure as follows (circled parameters need to be modified):

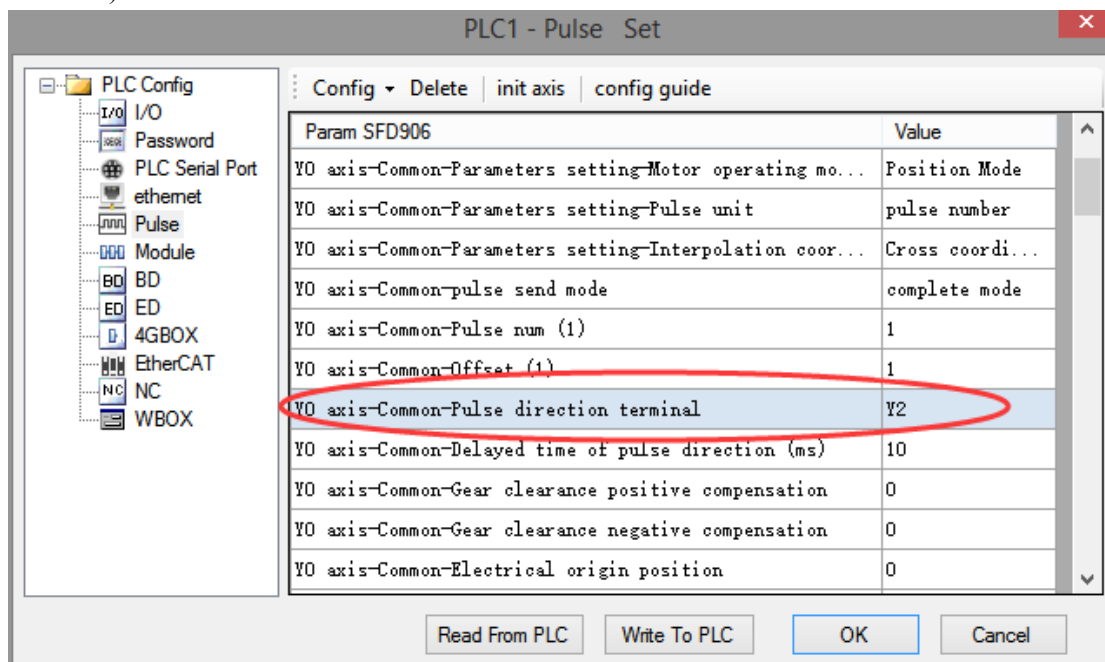



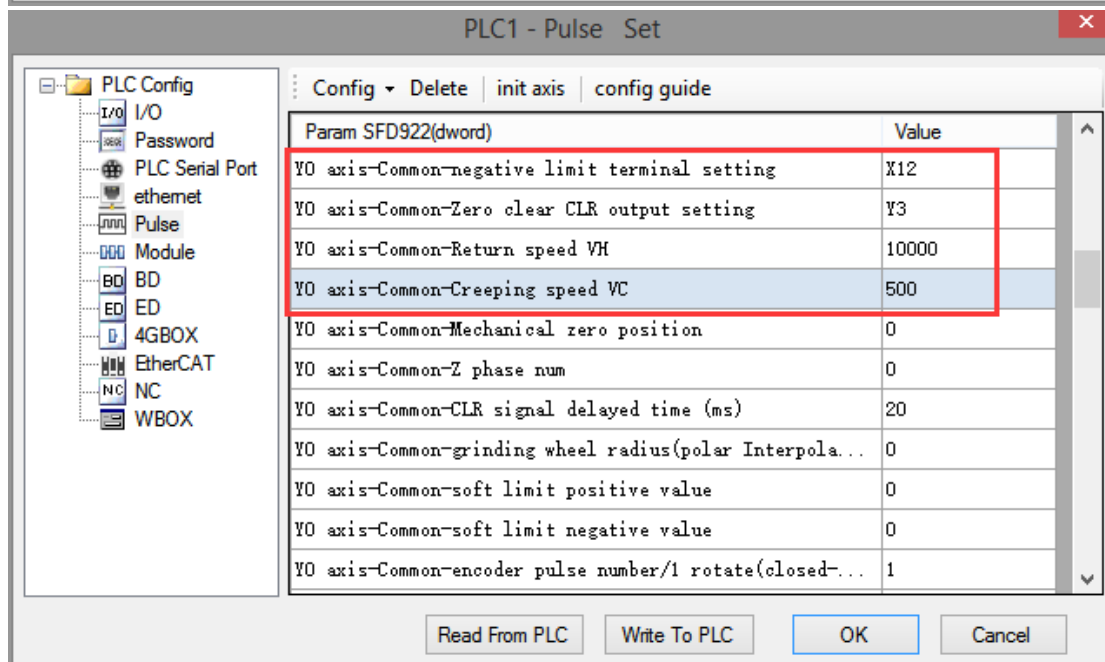
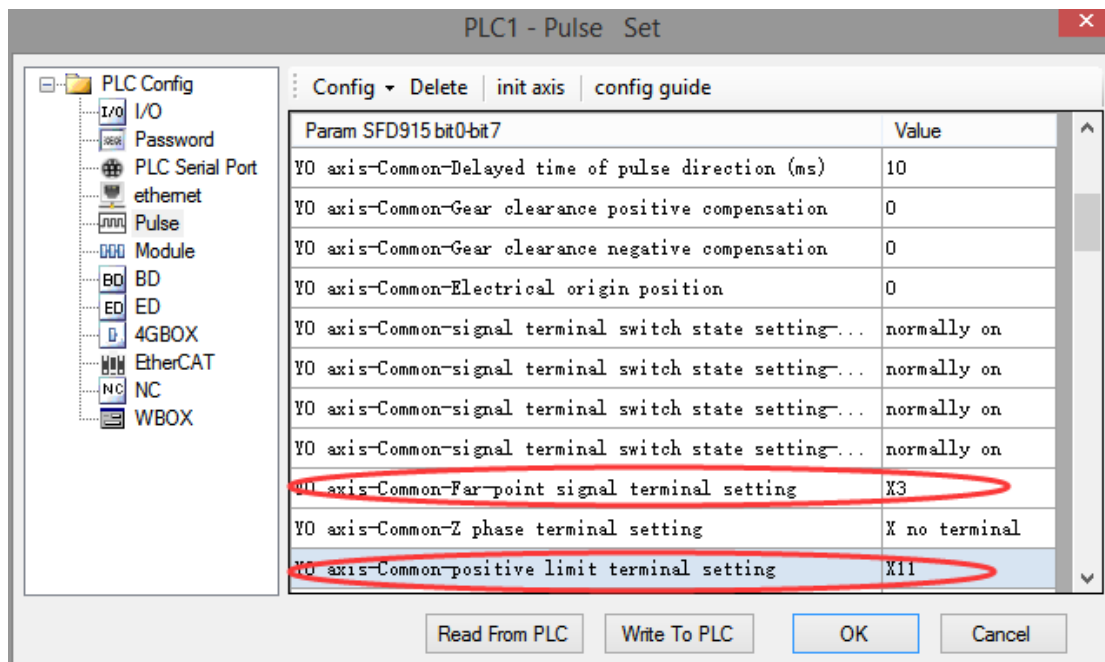

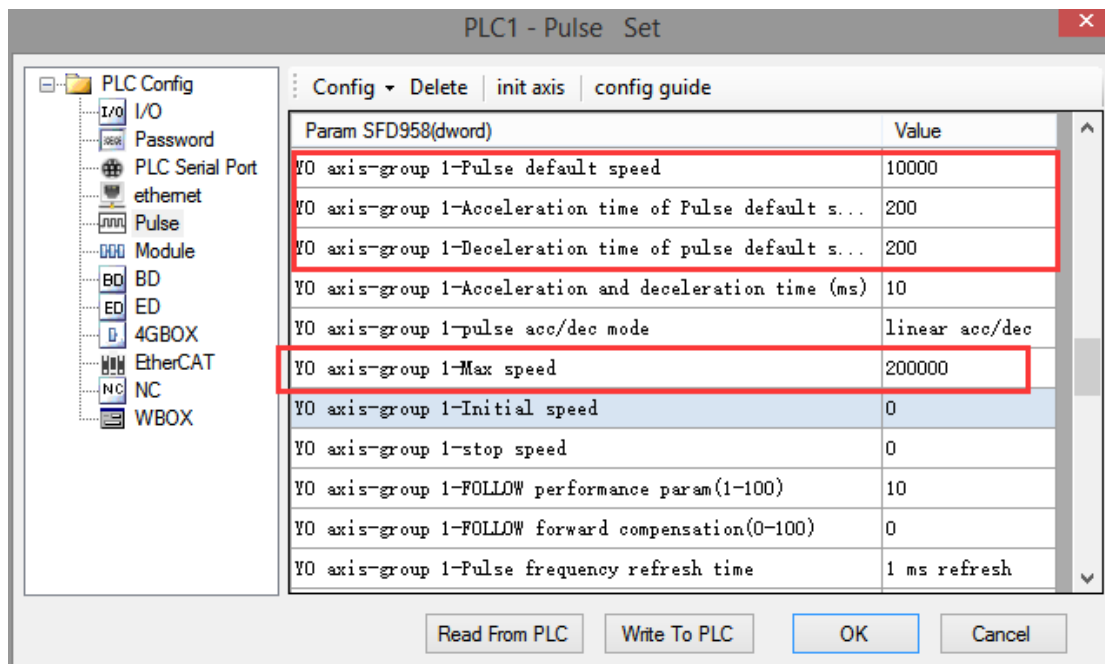

After configuring the parameters, click the "Write to PLC" button to write the parameters into the PLC. After downloading the program, power off the PLC and then power on again.

Positive Limit (X11) and Negative Limit (X12) will play an important role in the execution of ZRN, PLSE, DRVI and DRVA instructions.

**Example 2: According to the following figure, use the relative single segment positioning method.**

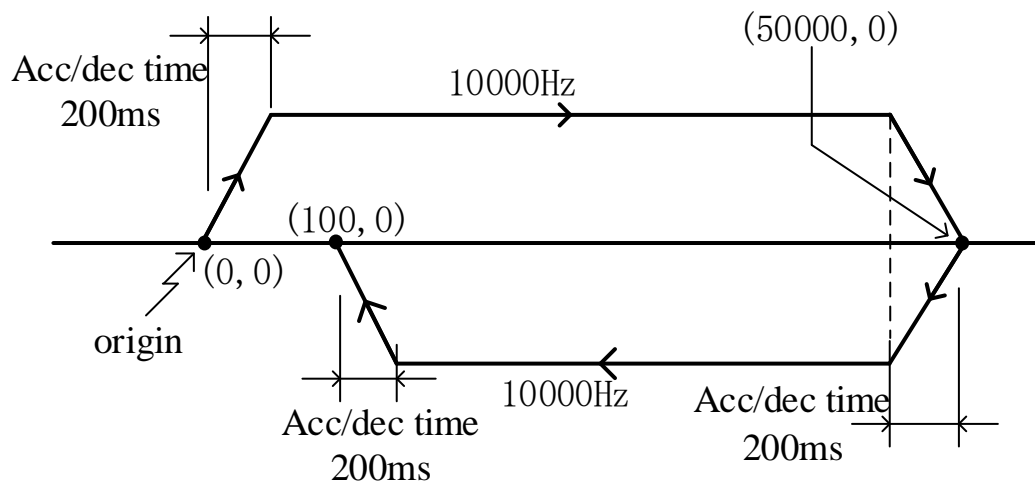

Firstly, make the ladder chart as follows:

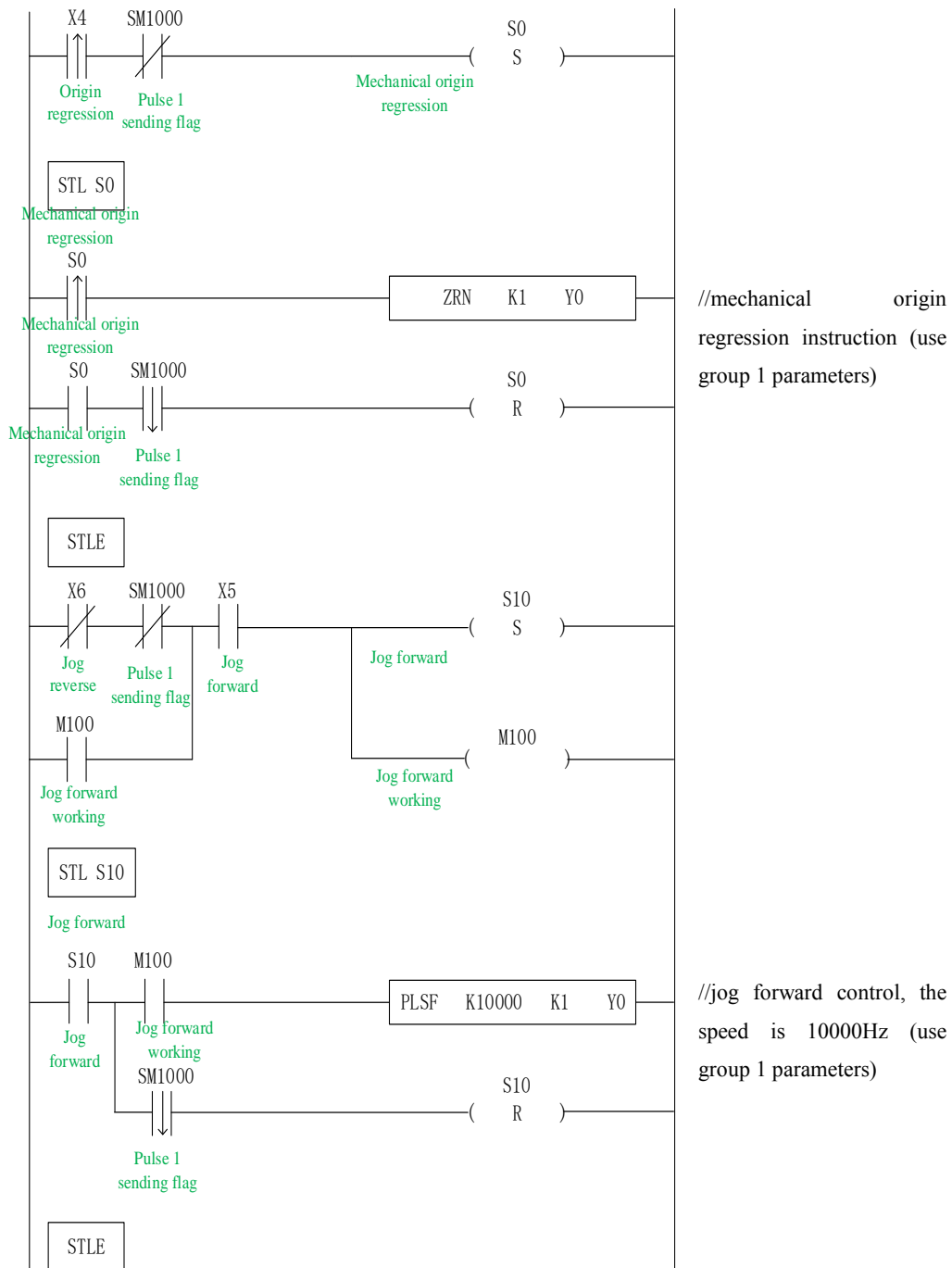

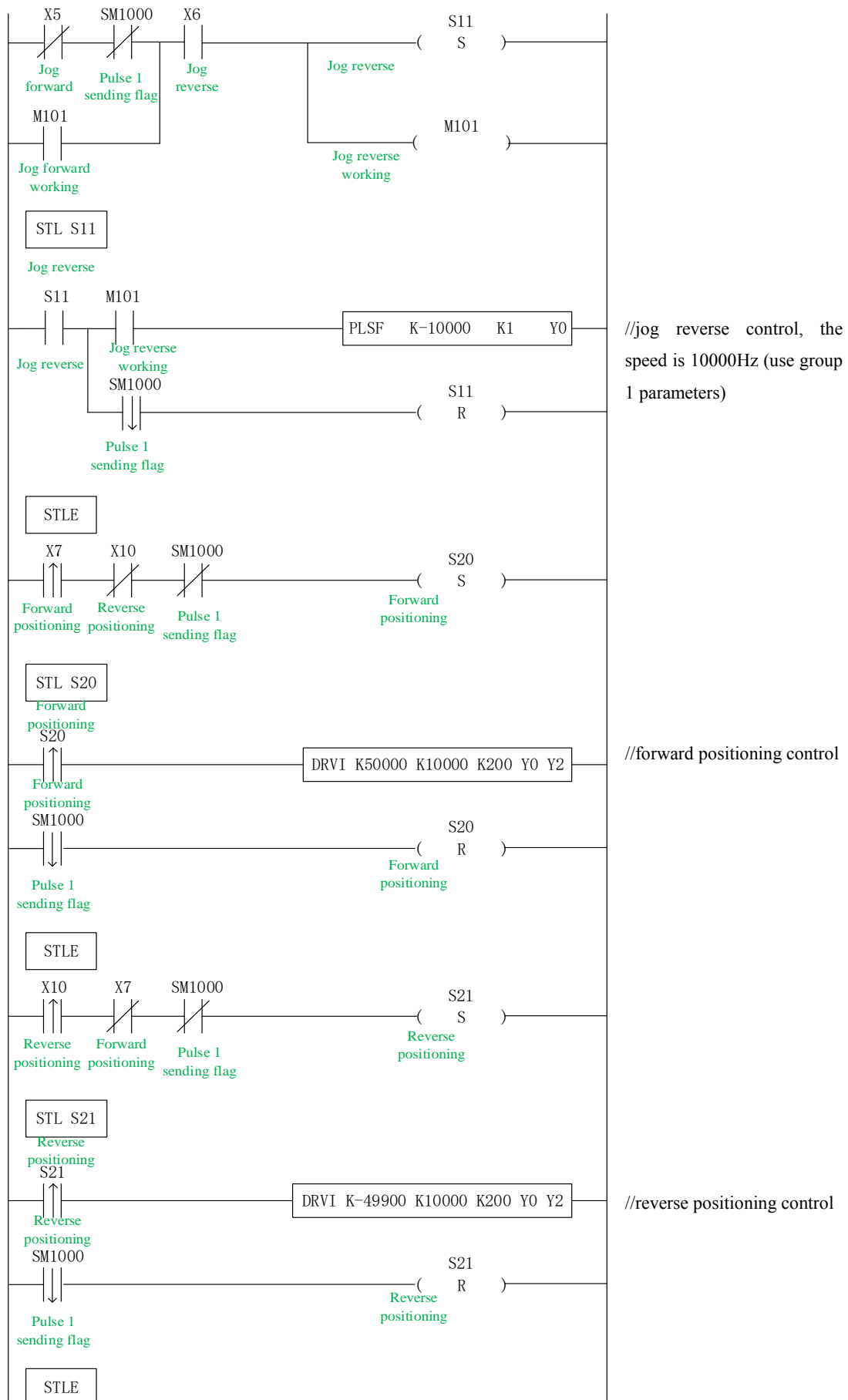

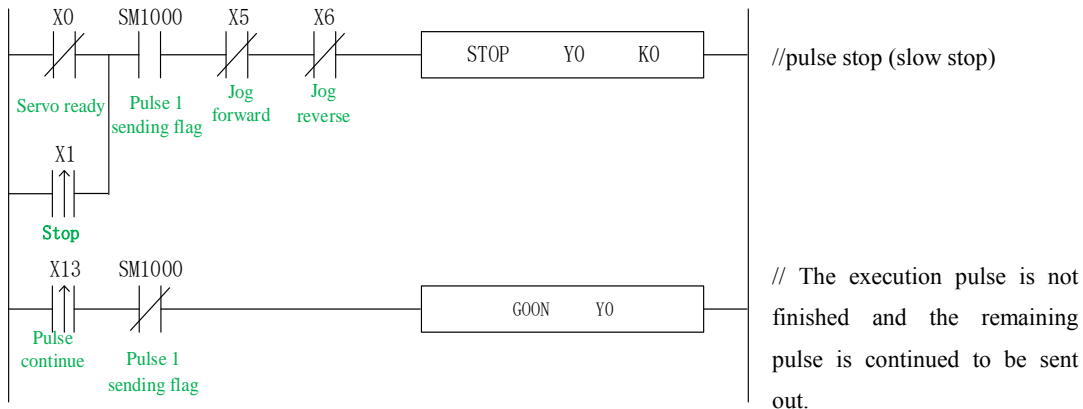

In the sample program, except DRVI and DRVA, all the system parameters used in the pulse instructions are group 1 parameters. So, we click "pulse configuration parameters" in the PLC programming software, as follows:

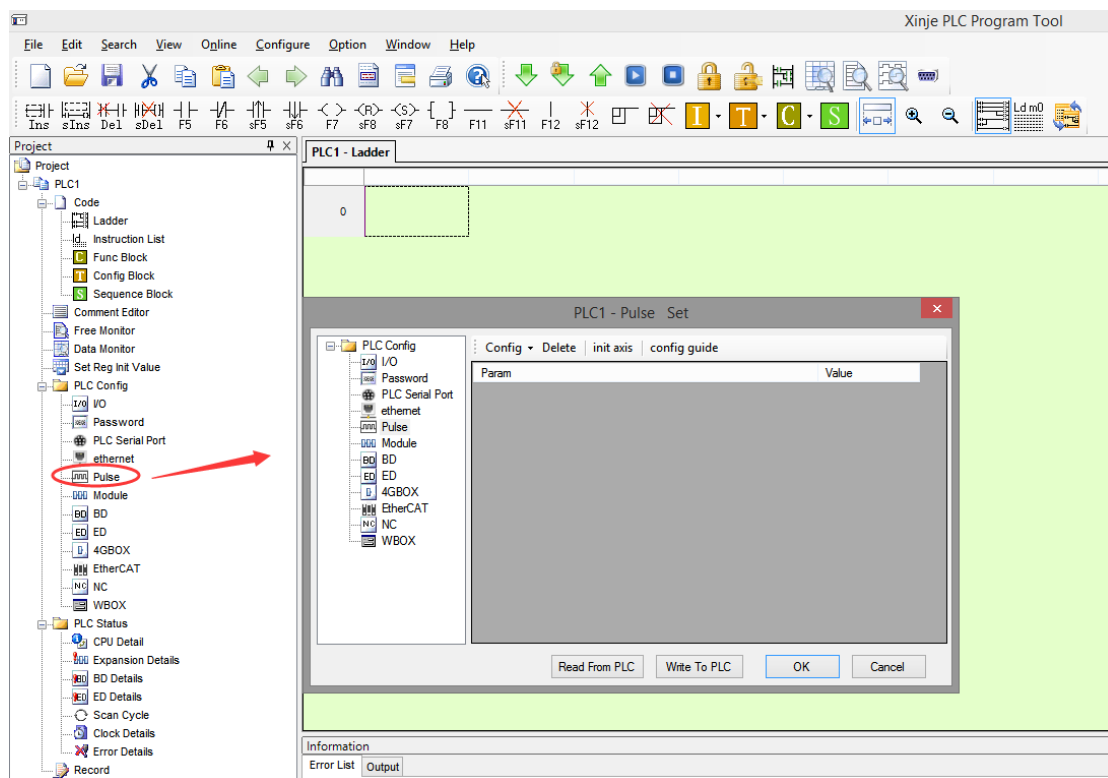

Click config, then select Y0 axis.

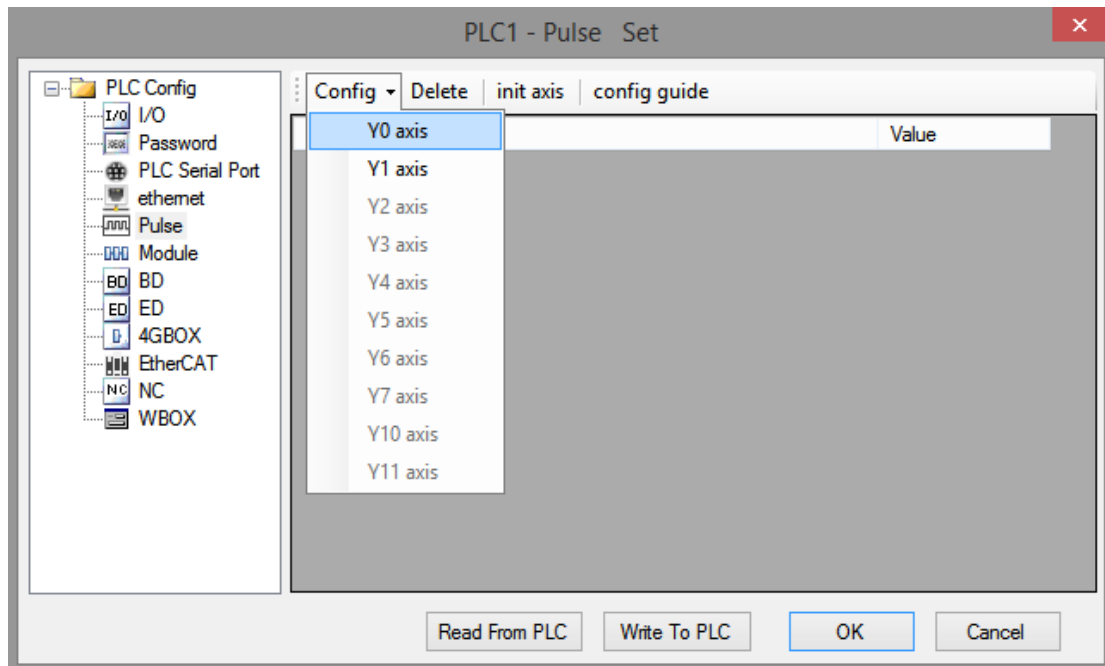

In the parameter configuration table, configure as follows (circled parameters need to be modified):

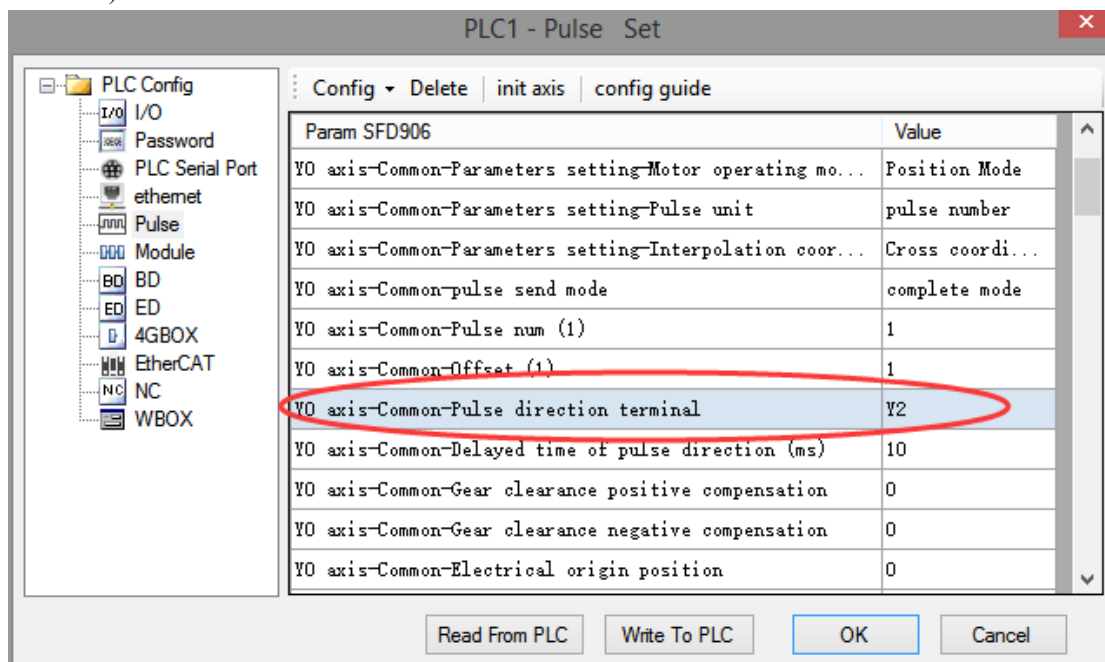

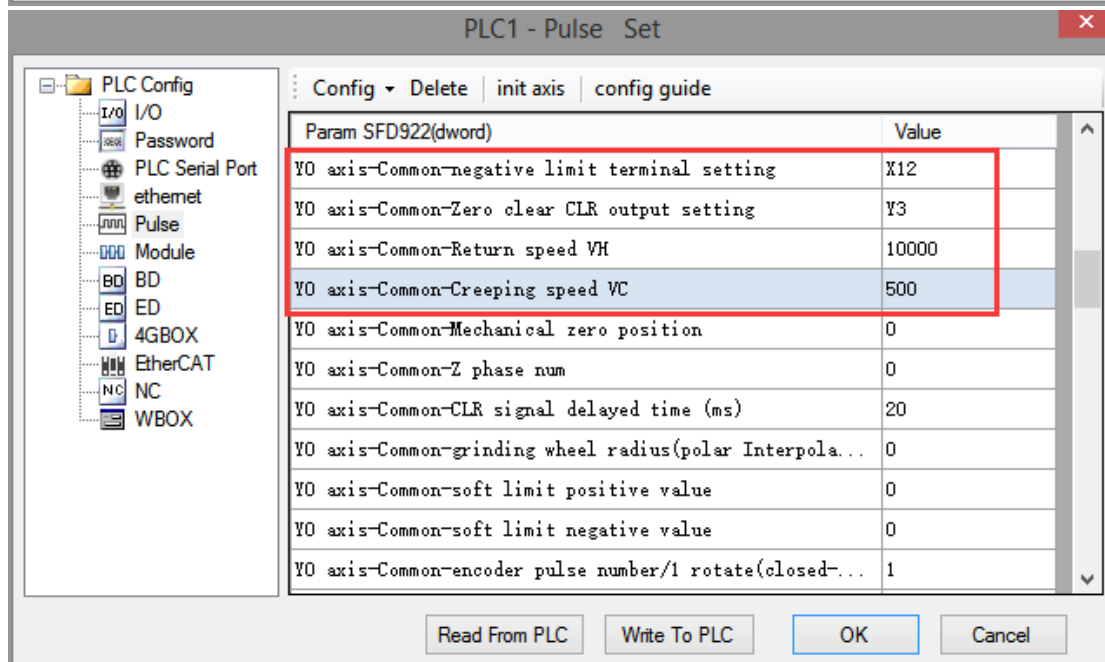
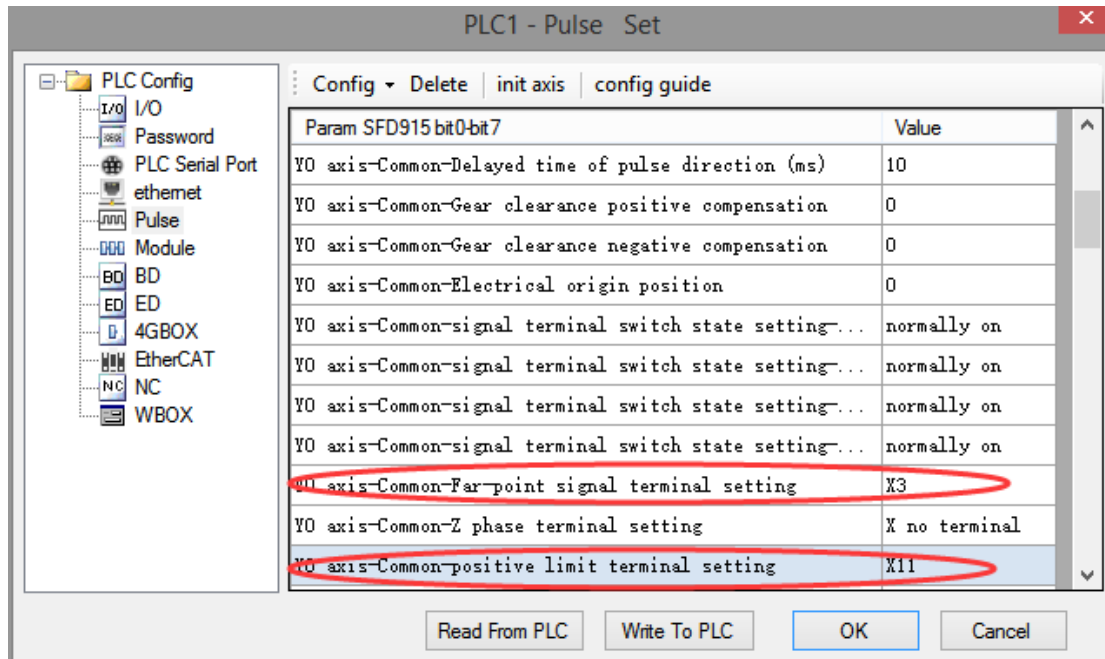



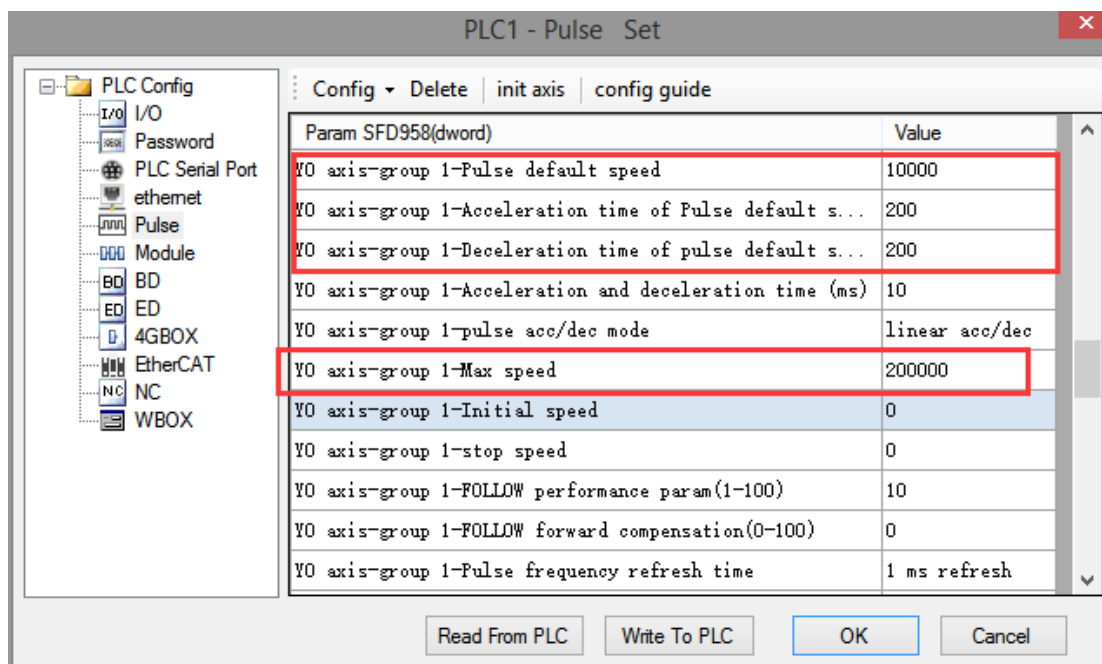

After configuring the parameters, click the "Write to PLC" button to write the parameters into the PLC. After downloading the program, power off the PLC and then power on again.

Positive Limit (X11) and Negative Limit (X12) will play an important role in the execution of ZRN, PLSF, DRVI and DRVA instructions.

#### 1-5-4. Forward and reverse rotation multi-section process program 【PLSF, PLSR, ZRN】

**Example 1:** According to the following figure, use multi-segment absolute positioning mode.

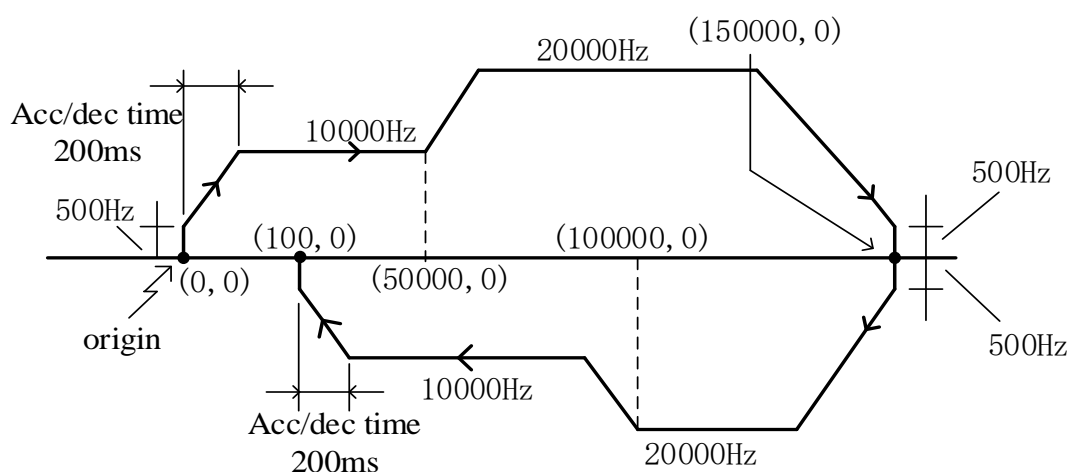

Firstly, make the ladder chart as follows:

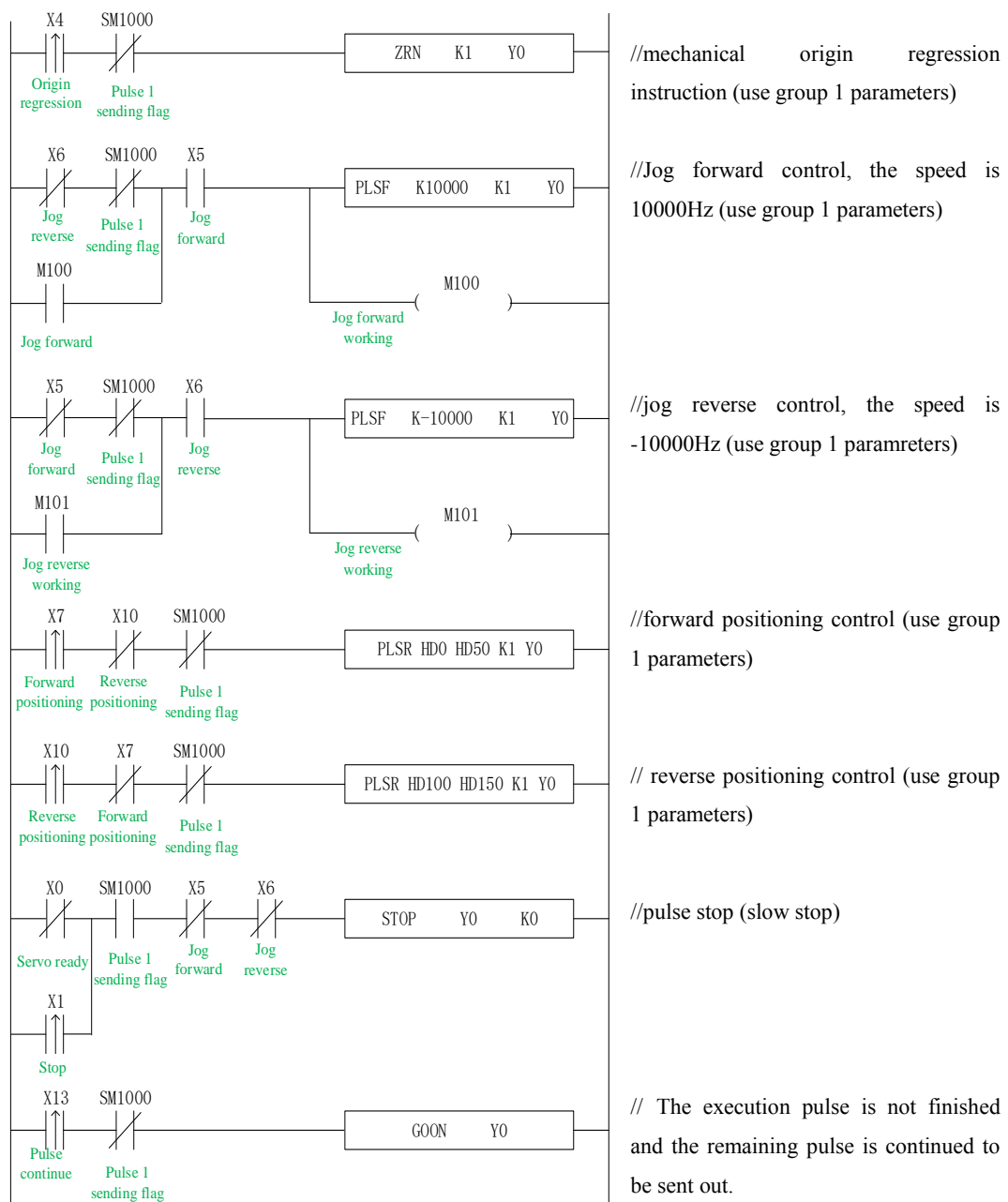

In the sample program, except DRVI and DRVA, all the system parameters used in the pulse instructions are group 1 parameters. So, we click "pulse configuration parameters" in the PLC programming software, as follows:

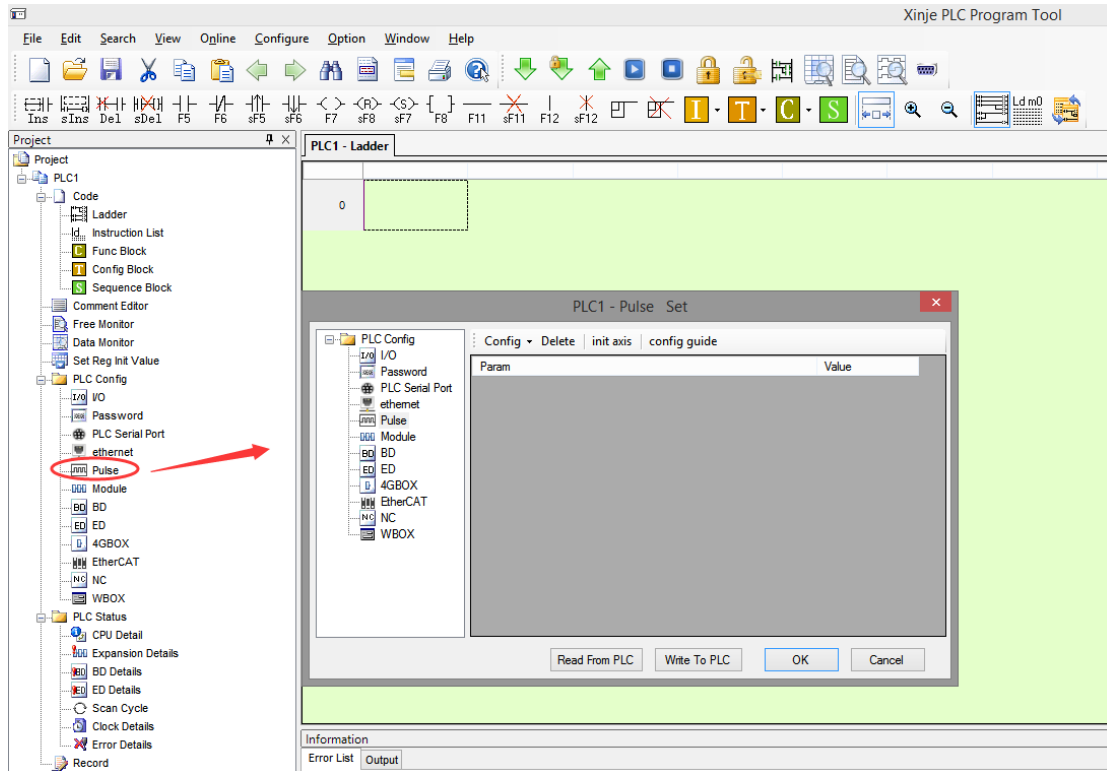

Click config, then select Y0 axis.

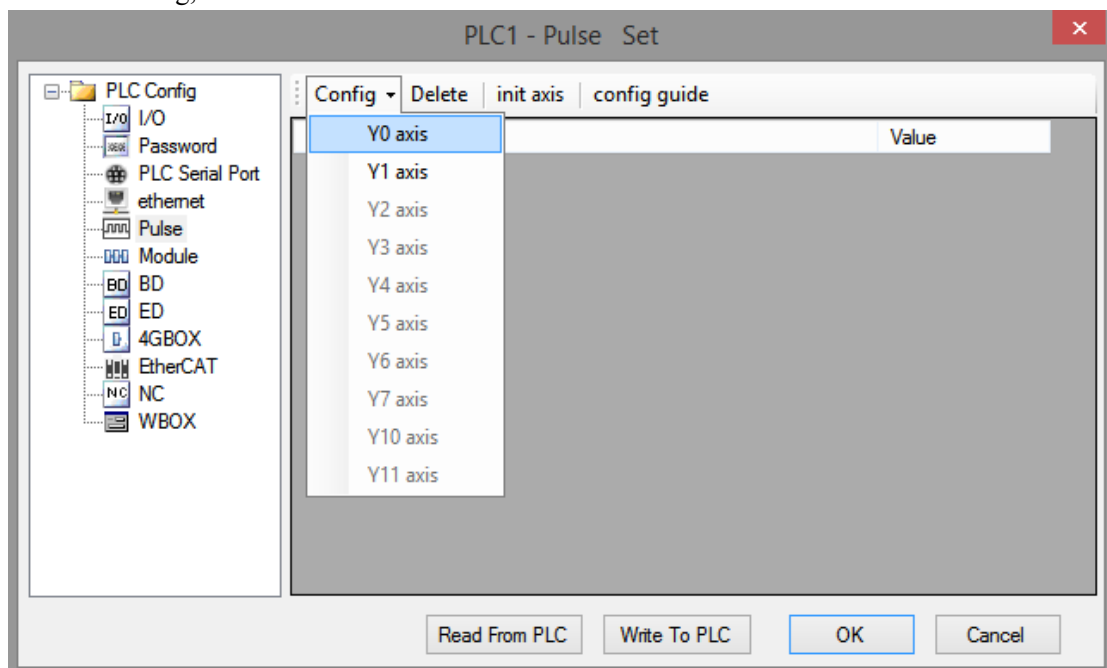

In the parameter configuration table, configure as follows (circled parameters need to be modified):

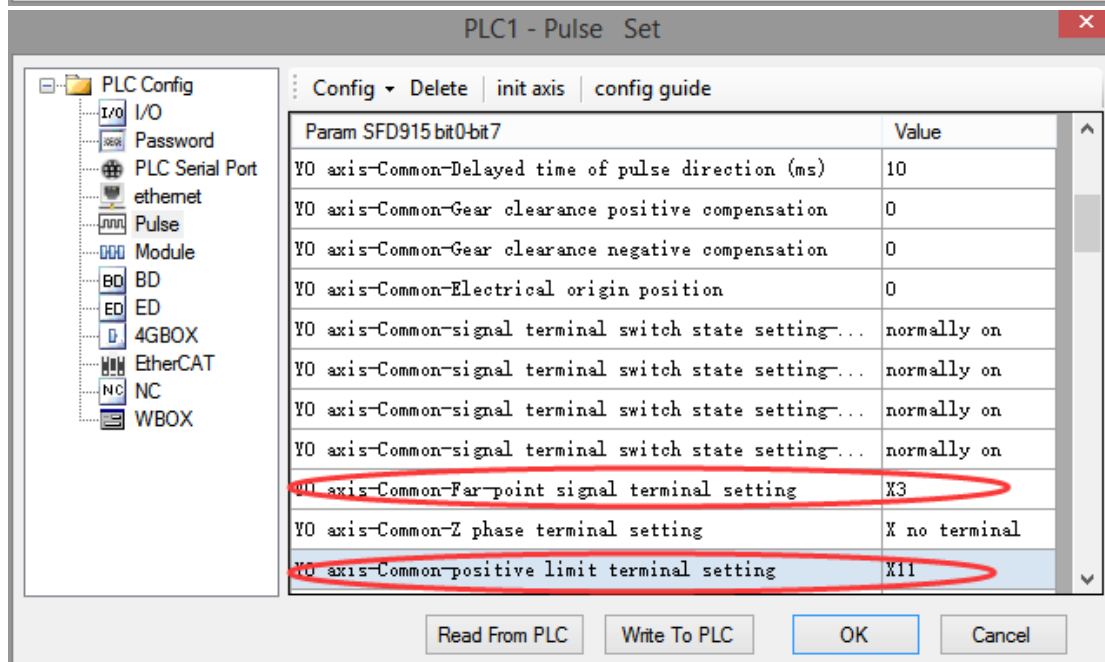
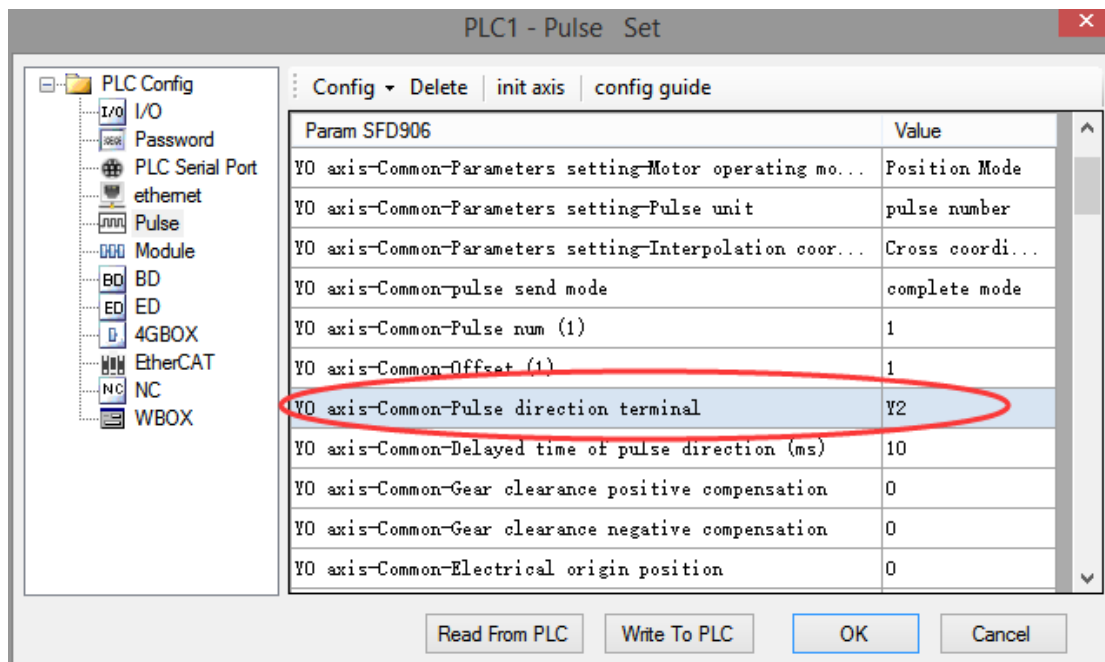

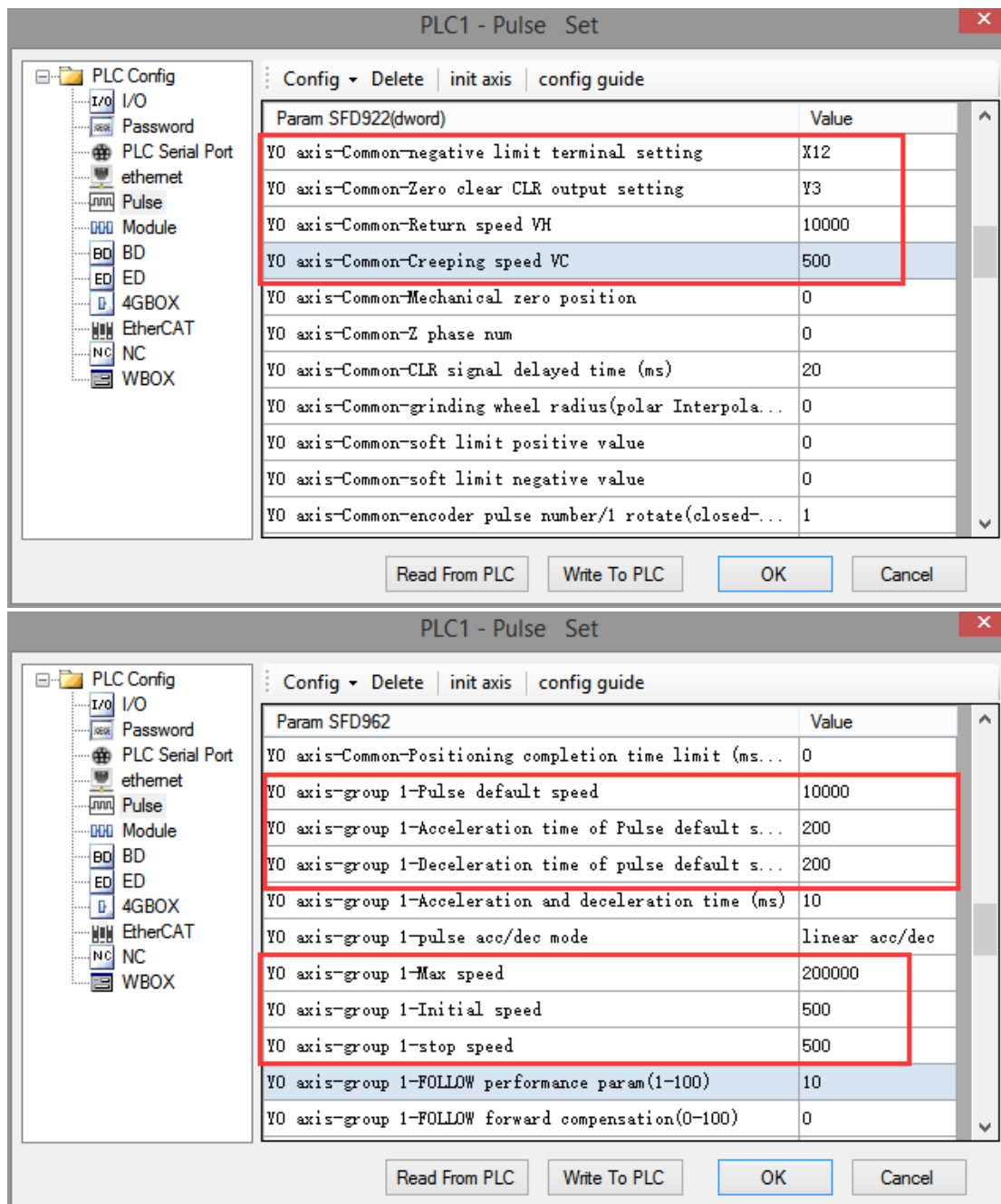

After configuring the parameters of the system parameter block, click the "Write to PLC" button to write the parameters into the PLC. Since the PLSR is used as the multi-segment pulse output instruction, we also need to configure the parameters of the pulse segment (the output frequency and the number of pulses per pulse segment).

Firstly, right-click on the forward positioning command PLSR and pop up the following options. Select the first "PLSR Instruction Parameter data Config":

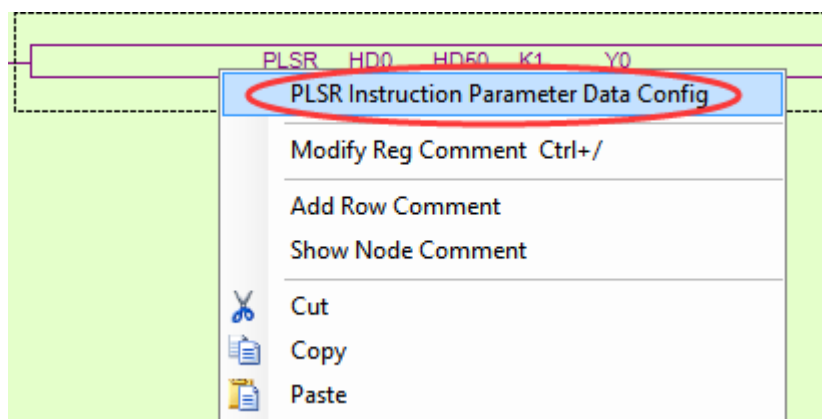

In the open multi-segment pulse output configuration table, select "mode" as "absolute" (default is "relative"), as shown in the following figure:

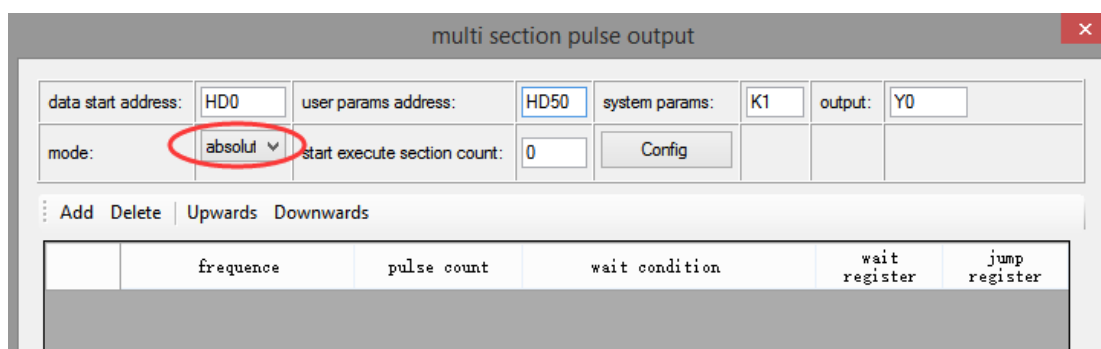

After choosing the mode, click the "Add" button in the configuration interface to add two continuous pulse parameters of forward rotation; after configuring, click the "Write to PLC" button to write parameters into the PLC, as shown in the following figure:

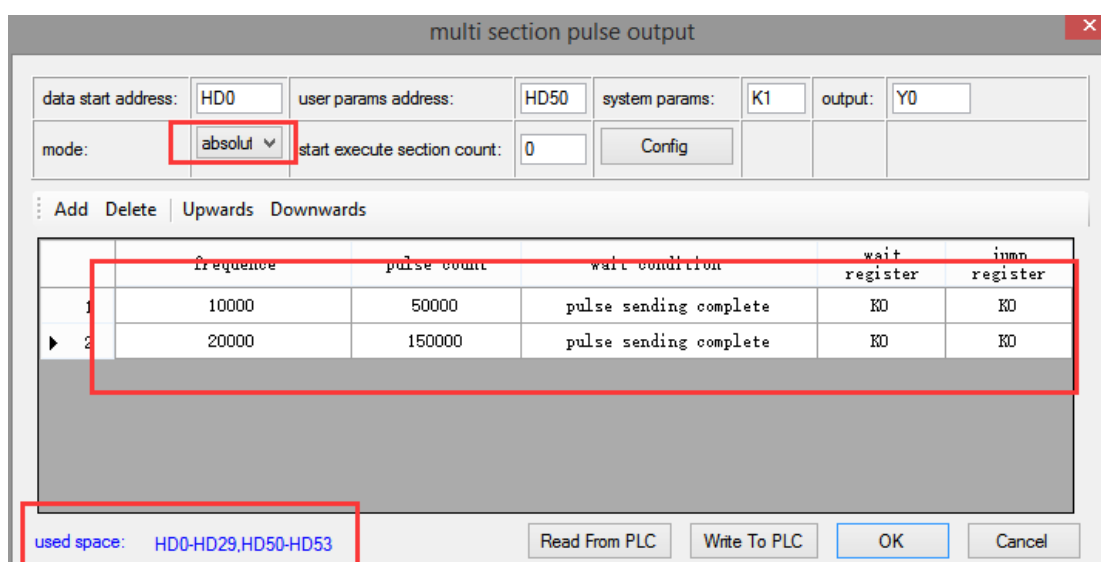

**Note:** Please note the range of real-time occupied registers displayed by "used space". Because the range of starting address of pulse parameter data of PLSR pulse instruction is HD0-HD29, and the range of system parameter block address is HD50-HD53, the range of real-time occupied registers address is not beyond the range. If the range exceeds, the error of pulse output will occur.

Then, right-click on the reverse positioning command PLSR and pop up the following options. Select the first "PLSR Instruction Parameter data Config":

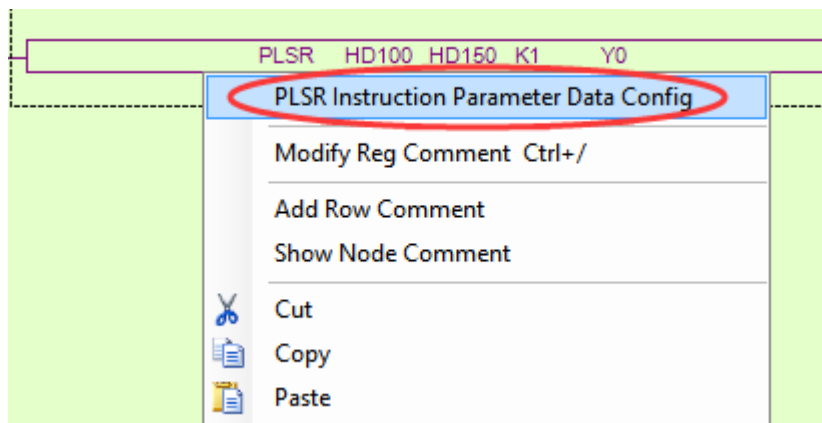

In the open multi-segment pulse output configuration table, select "mode" as "absolute" (default is "relative"), as shown in the following figure:

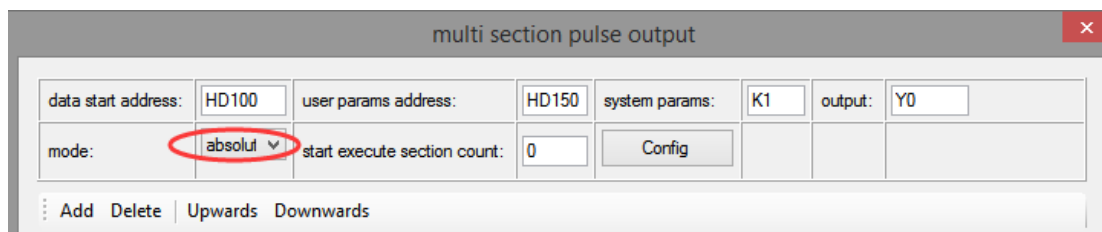

After choosing the mode, click the "Add" button in the configuration interface to add two continuous pulse parameters of forward rotation; after configuring, click the "Write to PLC" button to write parameters into the PLC, as shown in the following figure:

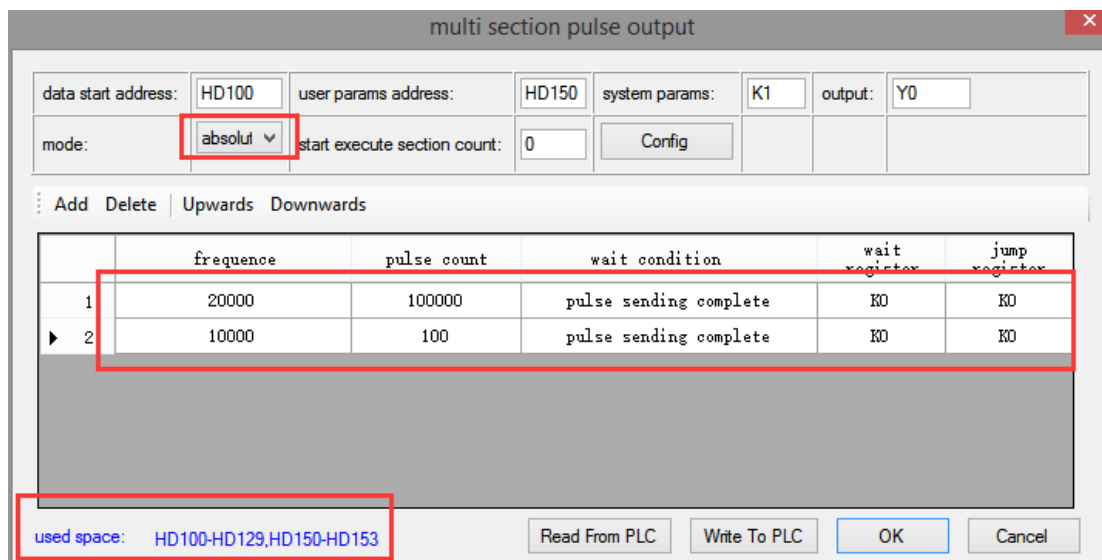

**Note:** Please note the range of real-time occupied registers displayed by "used space". Because the range of starting address of pulse parameter data of PLSR pulse instruction is HD100-HD129, and the range of system parameter block address is HD150-HD153, the range of real-time occupied registers address is not beyond the range. If the range exceeds, the error of pulse output will occur.

After downloading the program, power off the PLC and then re-energize it. Positive Limit (X11) and Negative Limit (X12) will play an important role in the execution of ZRN, PLSF, DRVI and DRVA instructions.

**Example 2: According to the following figure, multi-segment relative positioning method is used.**

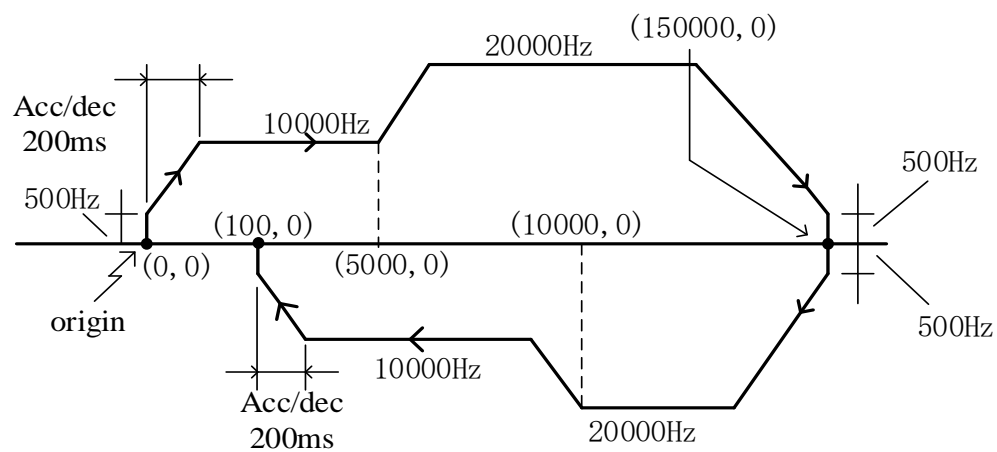

Firstly, make the ladder chart as follows:



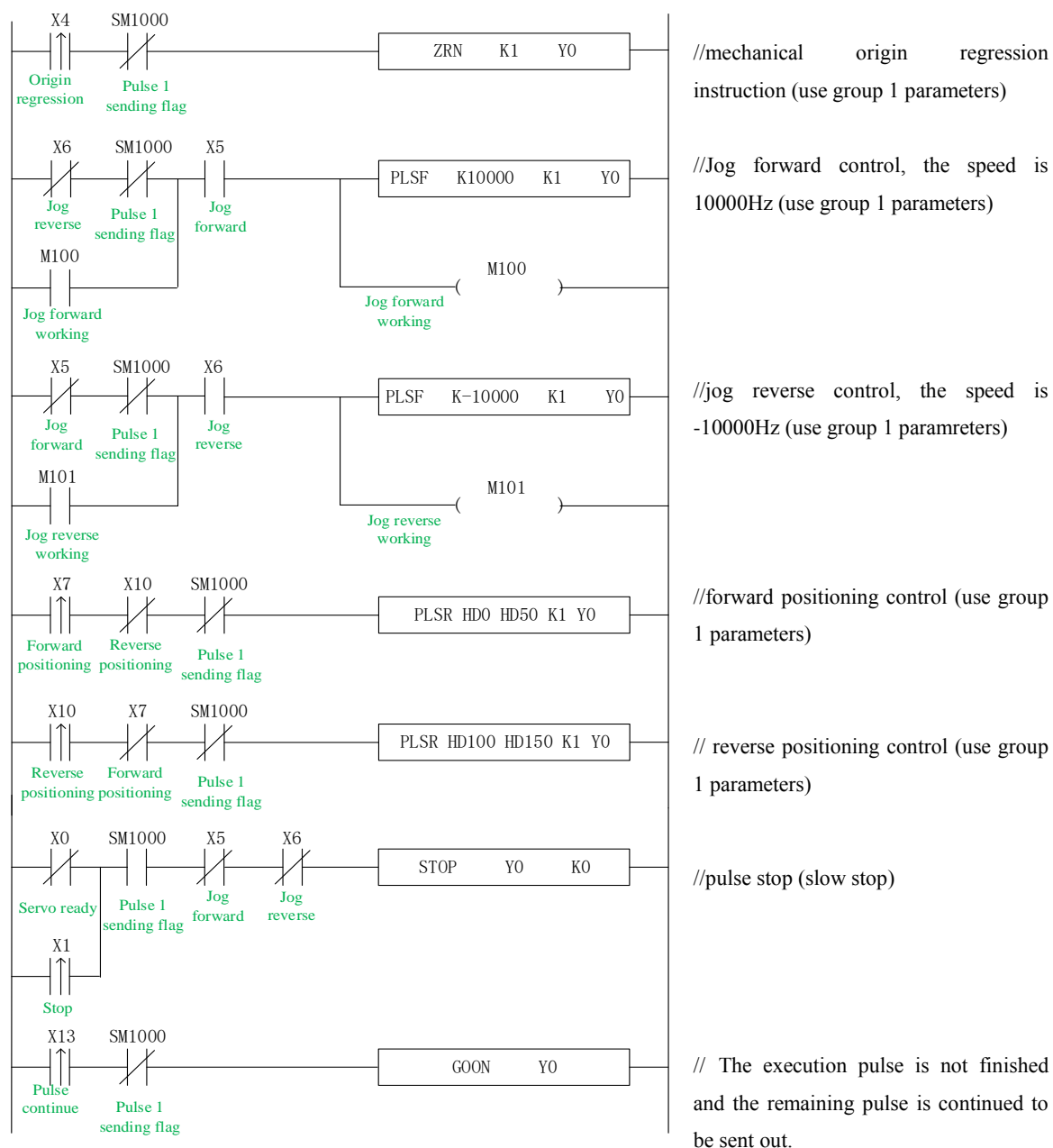

In the sample program, all the system parameters used in the pulse instructions are group 1 parameters. So, we click "pulse configuration parameters" in the PLC programming software, as follows:

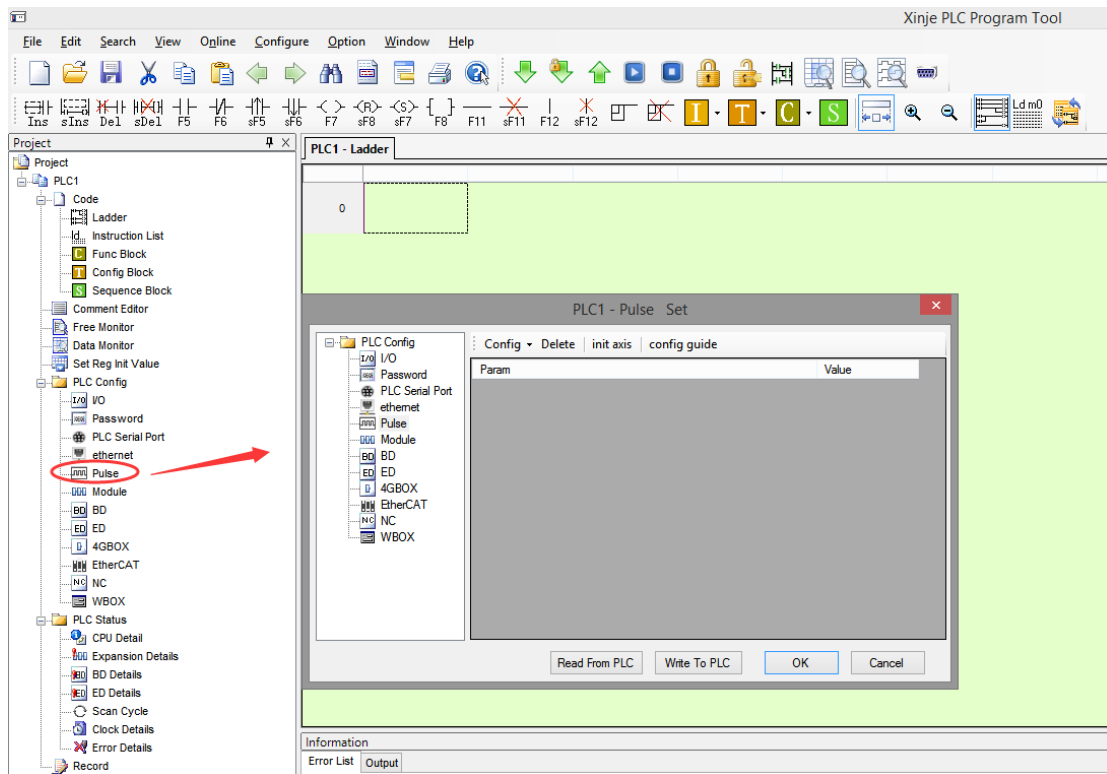

Click config, then select Y0 axis.

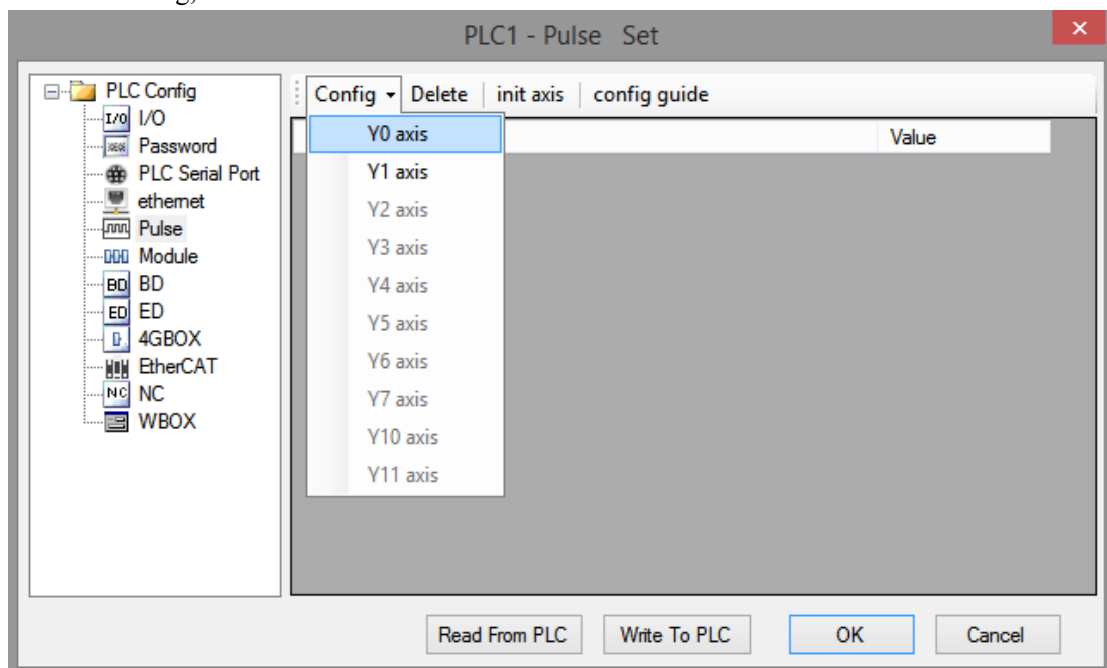

In the parameter configuration table, configure as follows (circled parameters need to be modified):

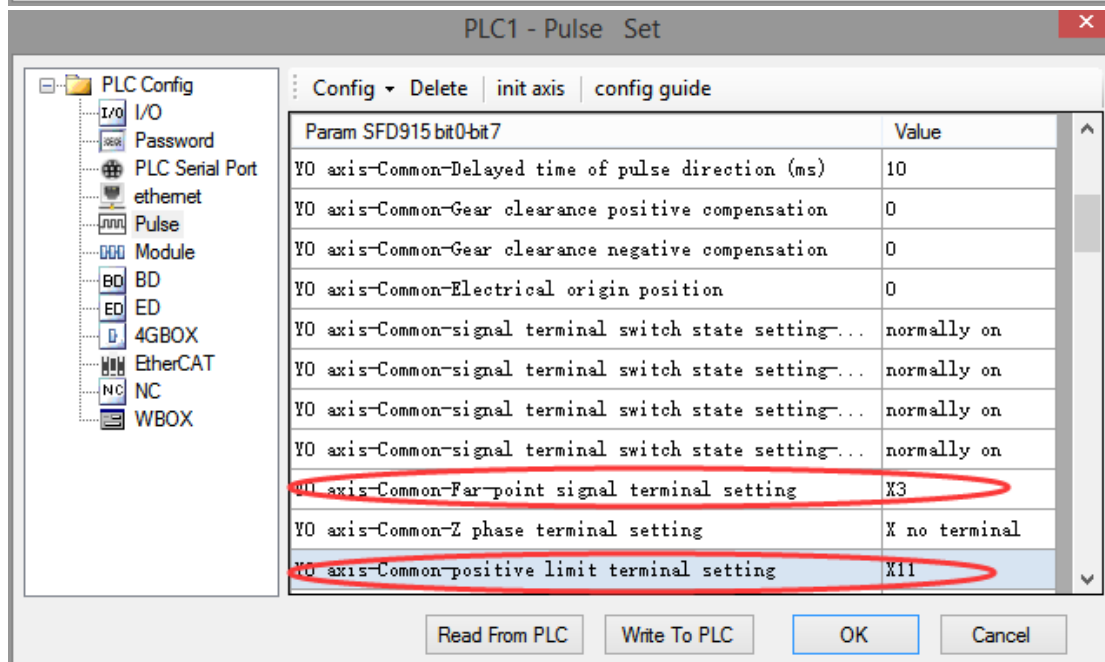
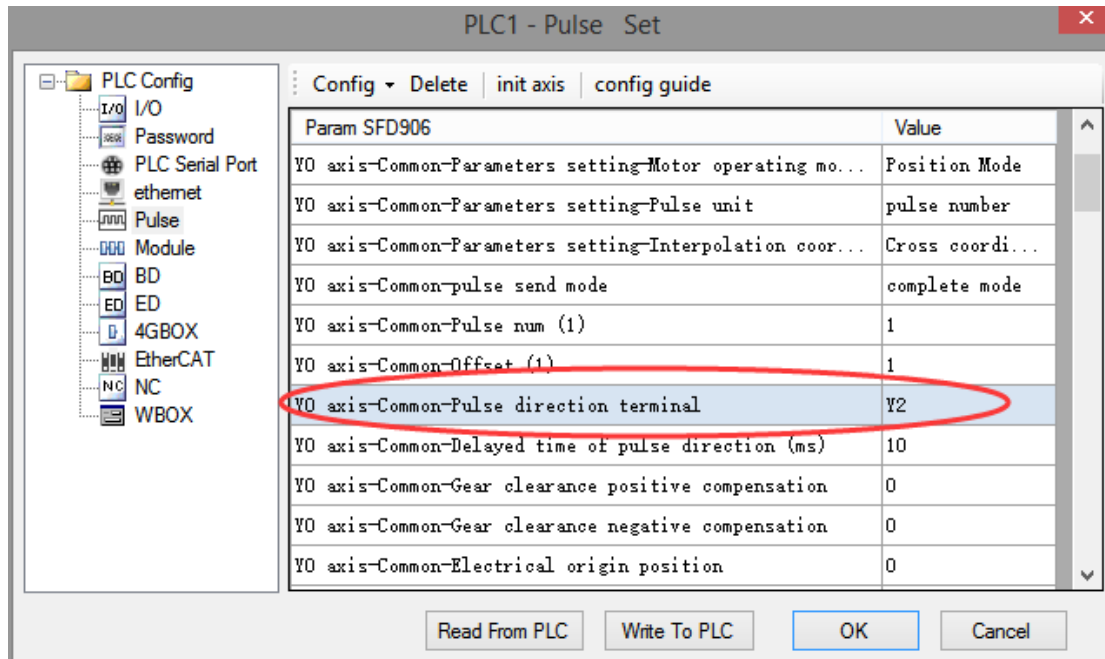

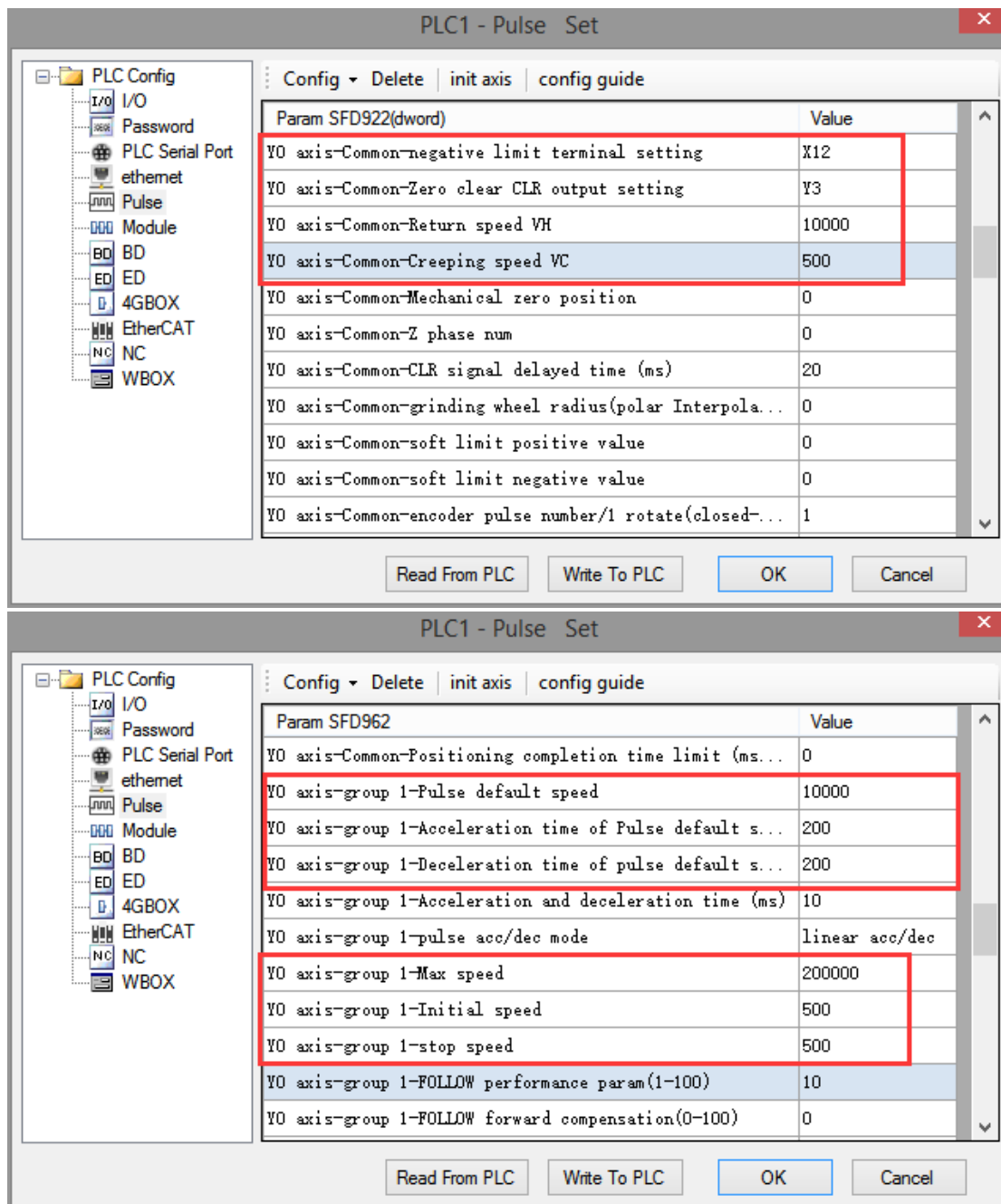

After configuring the parameters of the system parameter block, click the "Write to PLC" button to write the parameters into the PLC. Since the PLSR is used as the multi-segment pulse output instruction, we also need to configure the parameters of the pulse segment (the output frequency and the number of pulses per pulse segment).

Firstly, right-click on the forward positioning command PLSR and pop up the following options. Select the first "PLSR Instruction Parameter data Config":

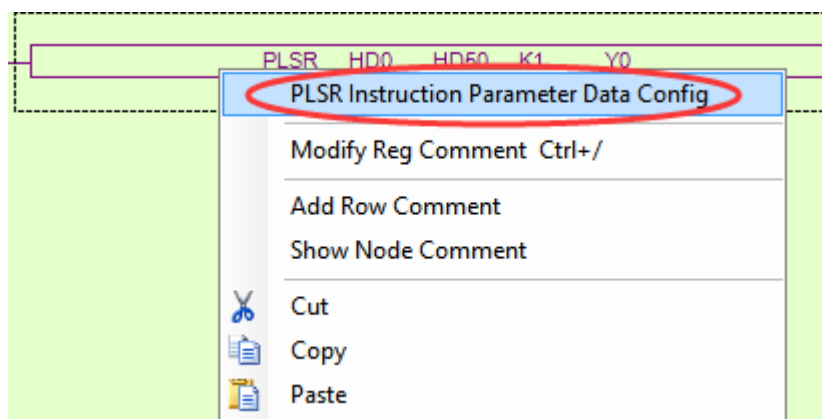

In the open multi-segment pulse output configuration table, select "mode" as "relative" (default is "relative"), as shown in the following figure:

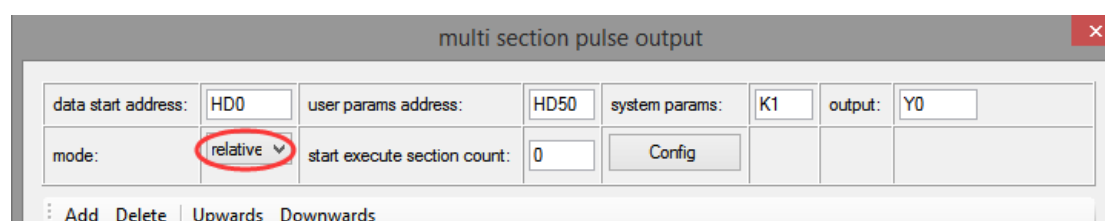

After choosing the mode, click the "Add" button in the configuration interface to add two continuous pulse parameters of forward rotation; after configuring, click the "Write to PLC" button to write parameters into the PLC, as shown in the following figure:

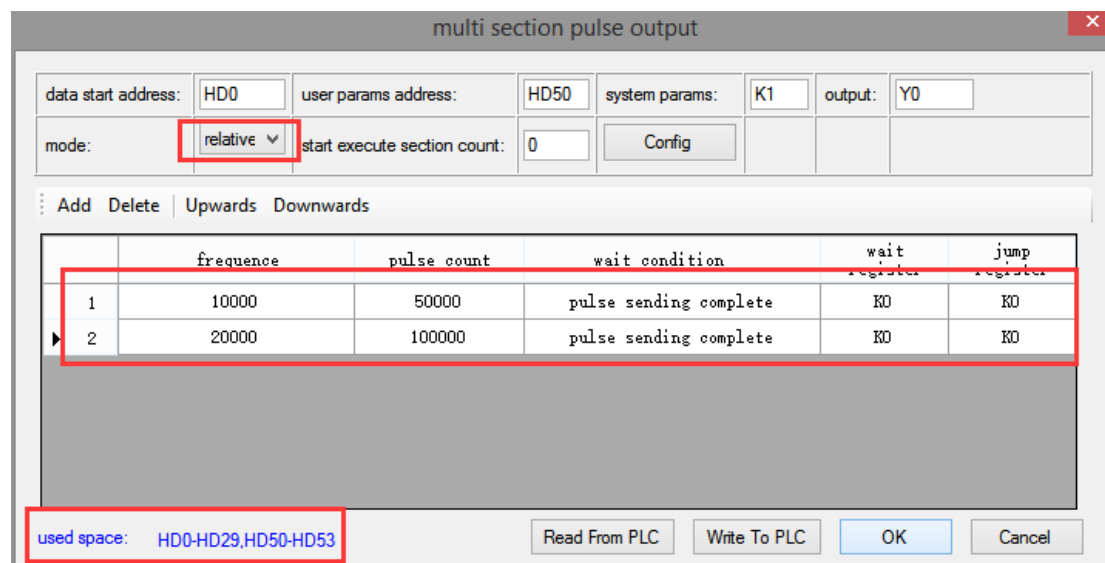

**Note:** Please note the range of real-time occupied registers displayed by "used space". Because the range of starting address of pulse parameter data of PLSR pulse instruction is HD0-HD29, and the range of system parameter block address is HD50-HD53, the range of real-time occupied registers address is not beyond the range. If the range exceeds, the error of pulse output will occur.

Then, right-click on the reverse positioning command PLSR and pop up the following options. Select the first "PLSR Instruction Parameter data Config":

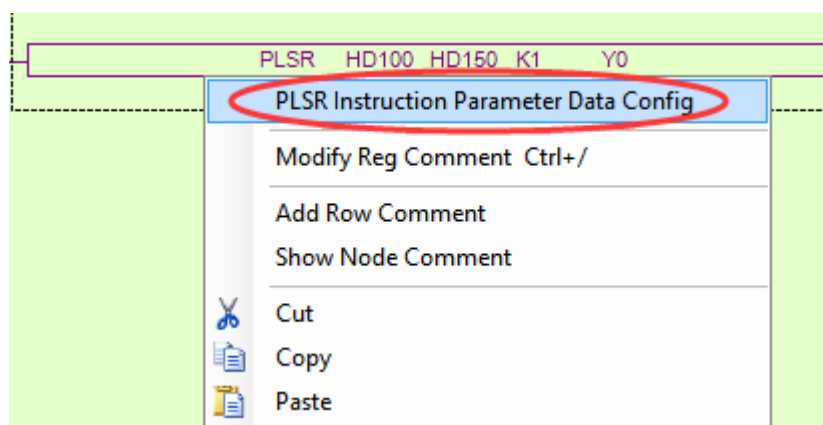

In the open multi-segment pulse output configuration table, select "mode" as "relative" (default is "relative"), as shown in the following figure:

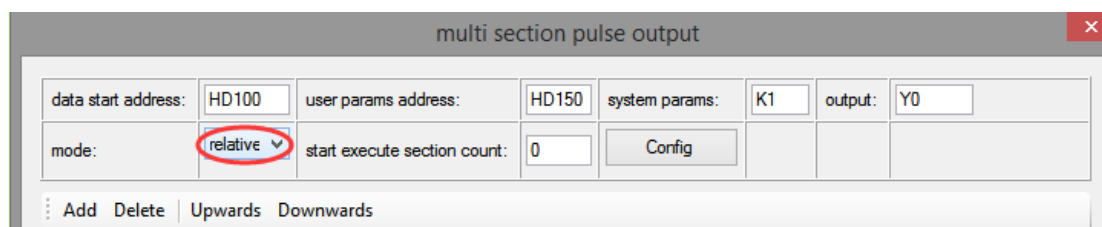

After choosing the mode, click the "Add" button in the configuration interface to add two continuous pulse parameters of reverse rotation; after configuring, click the "Write to PLC" button to write parameters into the PLC, as shown in the following figure:

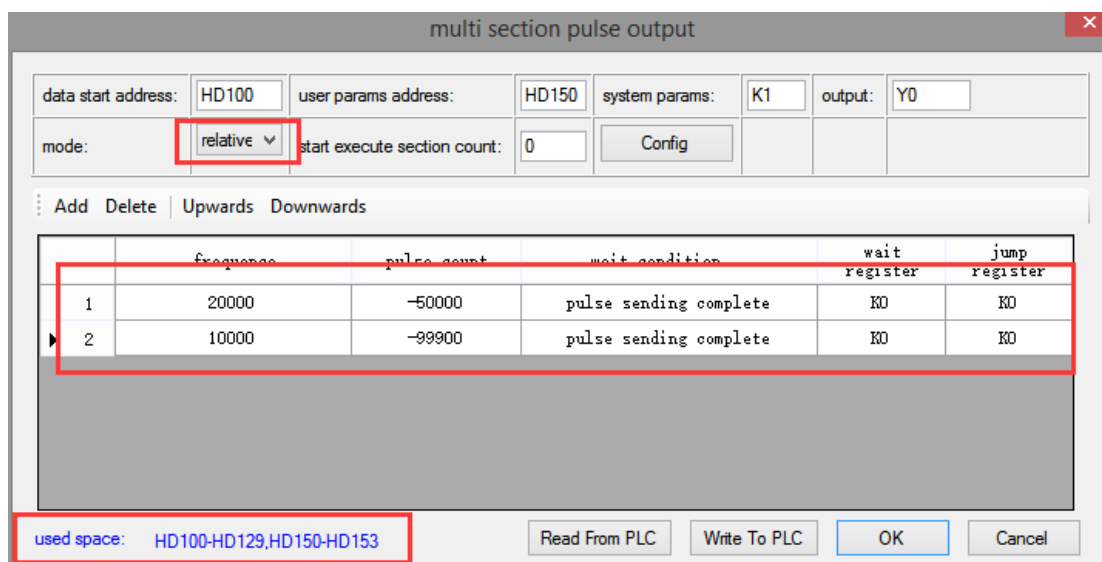

**Note:** Please note the range of real-time occupied registers displayed by "used space". Because the range of starting address of pulse parameter data of PLSR pulse instruction is HD100-HD129, and the range of system parameter block address is HD150-HD153, the range of real-time occupied registers address is not beyond the range. If the range exceeds, the error of pulse output will occur.

After downloading the program, power off the PLC and then re-energize it. Positive Limit (X11) and Negative Limit (X12) will play an important role in the execution of ZRN, PLSF, DRVI and DRVA instructions.

### 1-5-5. Forward reverse multi-segment process program 【PLSF, PLSR, ZRN】

**Example 1:** According to the following figure, multi-segment absolute positioning is used.

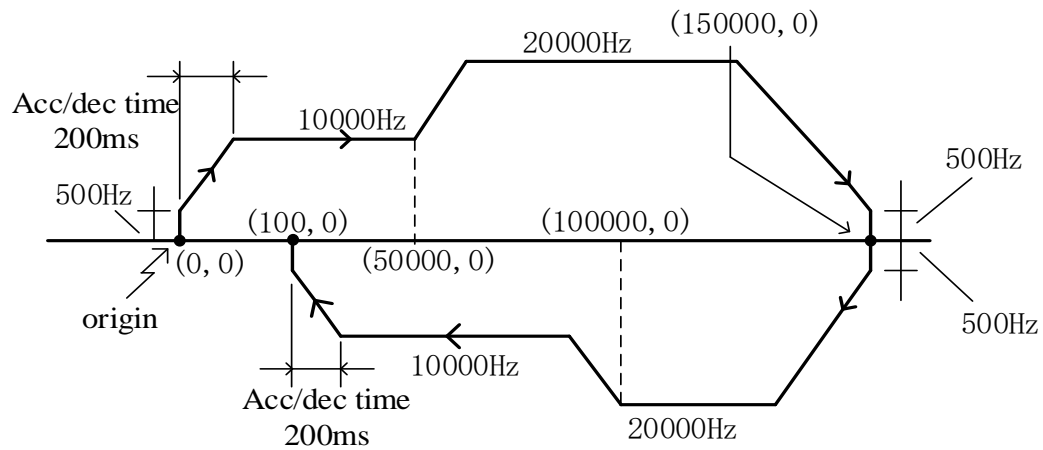

Firstly, make the ladder chart as follows:

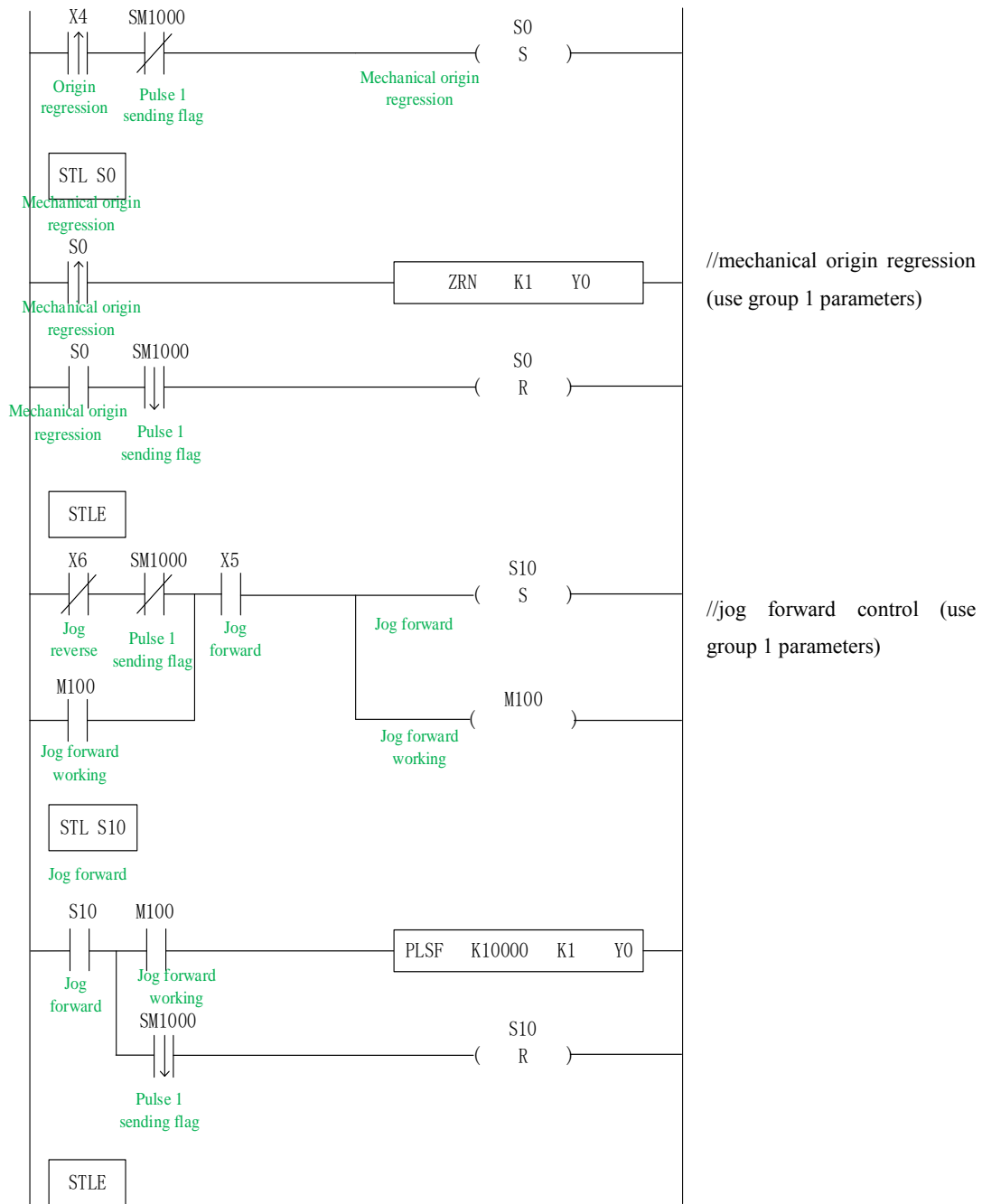



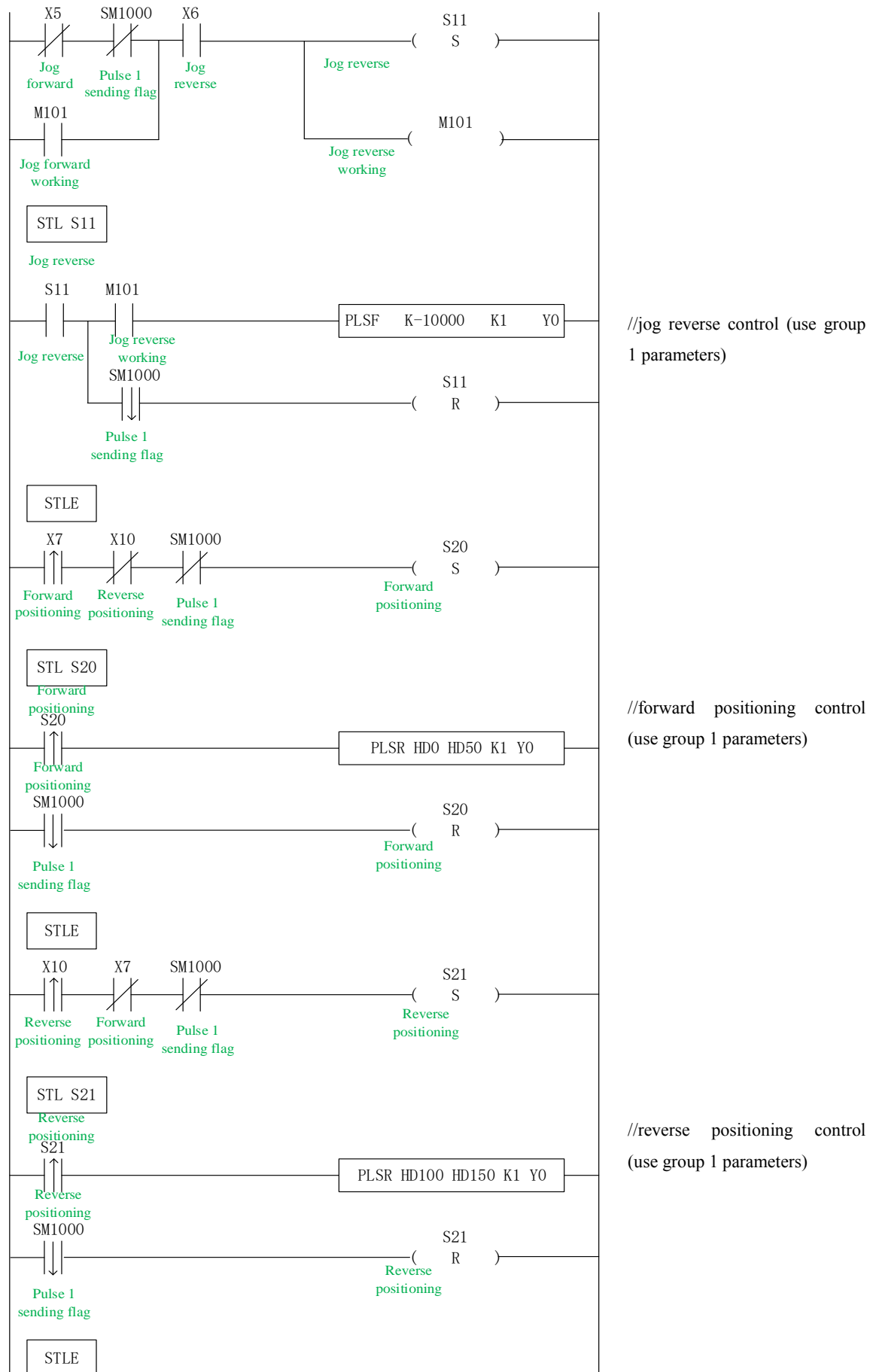

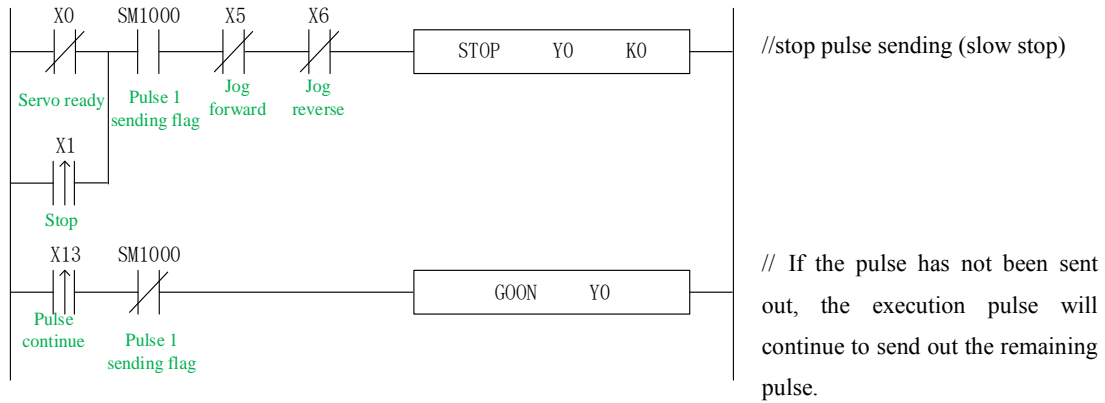

In the sample program, all the system parameters used in the pulse instructions are group 1 parameters. So, we click "pulse configuration parameters" in the PLC programming software, as follows:

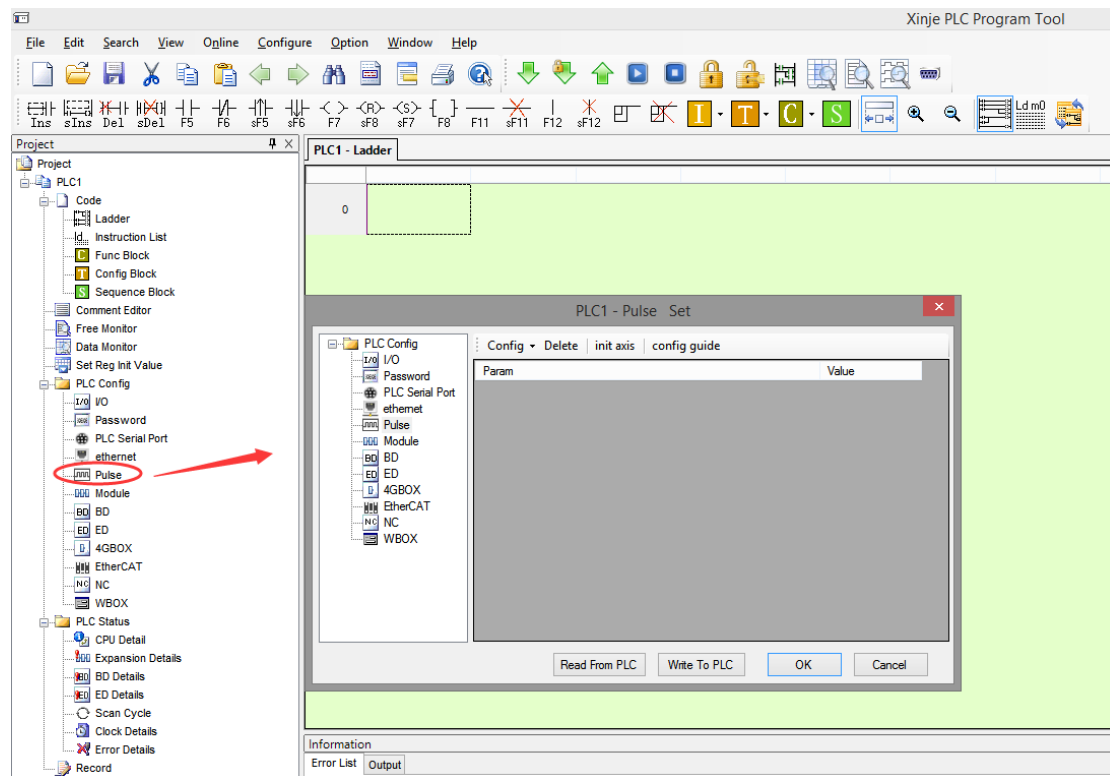

Click config, then select Y0 axis.

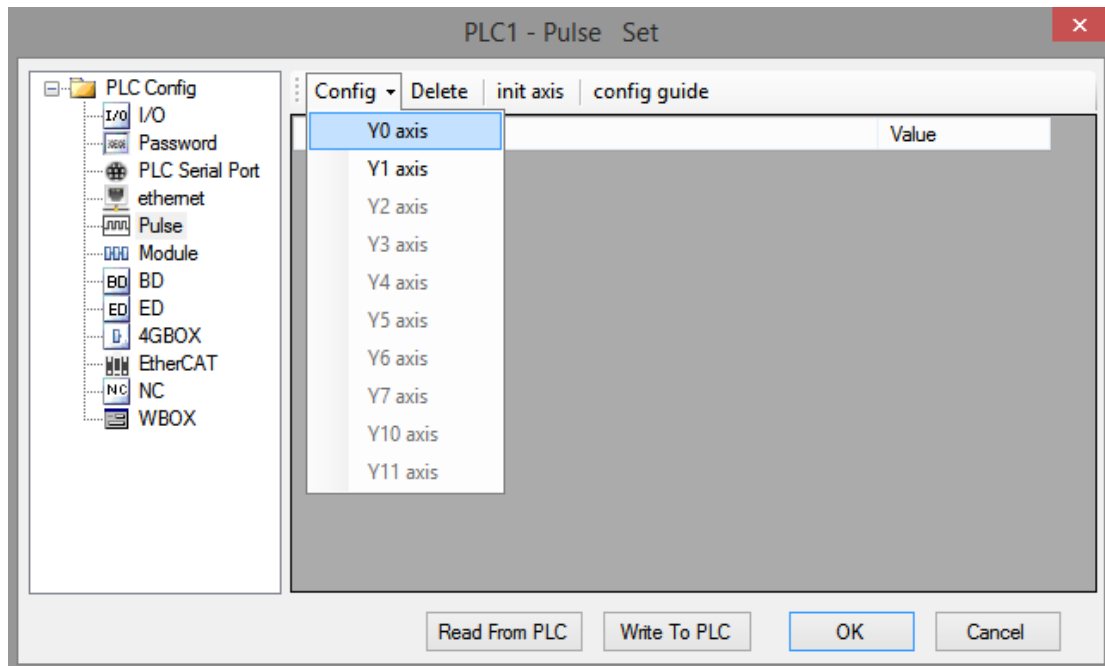

In the parameter configuration table, configure as follows (circled parameters need to be modified):

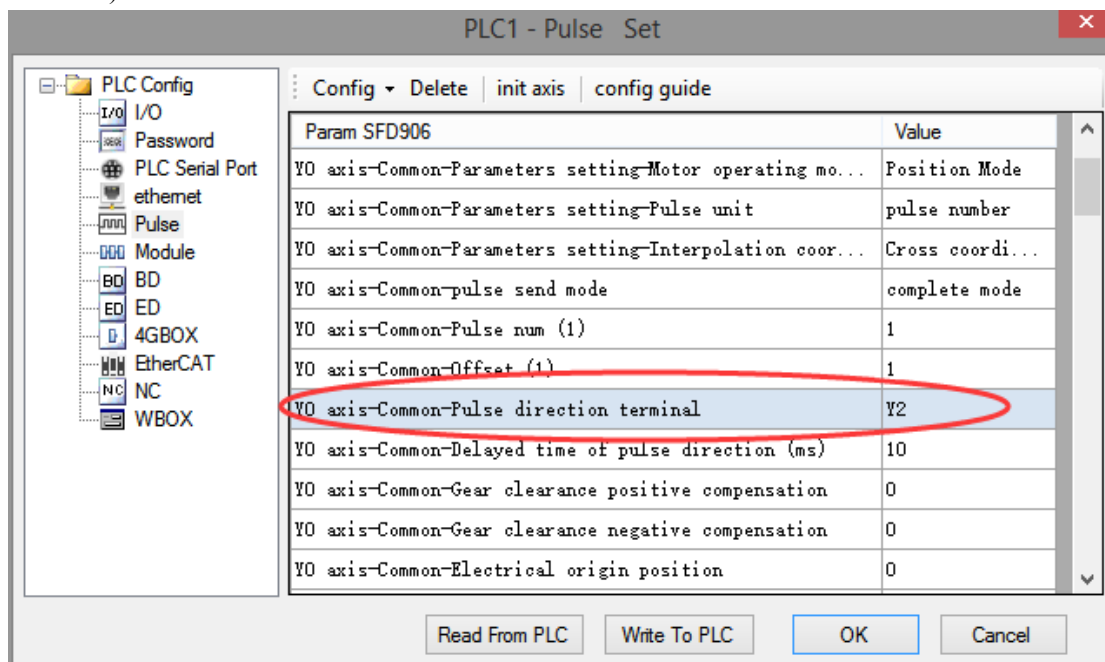

PLC1 - Pulse Set

Config ▾ Delete | init axis | config guide

PLC Config

- I/O
- Password
- PLC Serial Port
- ethernet
- Pulse
- Module
- BD
- ED
- 4GBOX
- EtherCAT
- NC
- WBOX

Param SFD915 bit0-bit7	Value
YO axis-Common-Delayed time of pulse direction (ms)	10
YO axis-Common-Gear clearance positive compensation	0
YO axis-Common-Gear clearance negative compensation	0
YO axis-Common-Electrical origin position	0
YO axis-Common-signal terminal switch state setting...	normally on
YO axis-Common-signal terminal switch state setting...	normally on
YO axis-Common-signal terminal switch state setting...	normally on
YO axis-Common-signal terminal switch state setting...	normally on
YO axis-Common-Far-point signal terminal setting	X3
YO axis-Common-Z phase terminal setting	X no terminal
YO axis-Common-positive limit terminal setting	X11

Read From PLC Write To PLC OK Cancel

---

PLC1 - Pulse Set

Config ▾ Delete | init axis | config guide

PLC Config

- I/O
- Password
- PLC Serial Port
- ethernet
- Pulse
- Module
- BD
- ED
- 4GBOX
- EtherCAT
- NC
- WBOX

Param SFD922(dword)	Value
YO axis-Common-negative limit terminal setting	X12
YO axis-Common-Zero clear CLR output setting	Y3
YO axis-Common-Return speed VH	10000
YO axis-Common-Creeping speed VC	500
YO axis-Common-Mechanical zero position	0
YO axis-Common-Z phase num	0
YO axis-Common-CLR signal delayed time (ms)	20
YO axis-Common-grinding wheel radius(polar Interpola...	0
YO axis-Common-soft limit positive value	0
YO axis-Common-soft limit negative value	0
YO axis-Common-encoder pulse number/1 rotate(closed...	1

Read From PLC Write To PLC OK Cancel

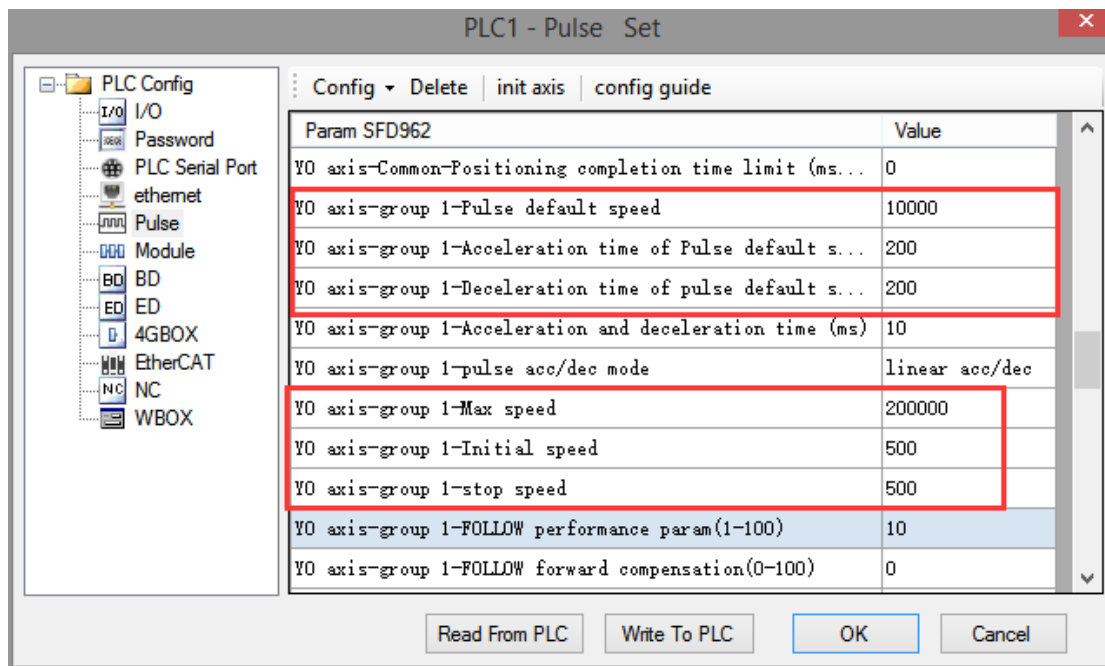

After configuring the parameters of the system parameter block, click the "Write to PLC" button to write the parameters into the PLC. Since the PLSR is used as the multi-segment pulse output instruction, we also need to configure the parameters of the pulse segment (the output frequency and the number of pulses per pulse segment).

Firstly, right-click on the forward positioning command PLSR and pop up the following options. Select the first "PLSR Instruction Parameter data Config":

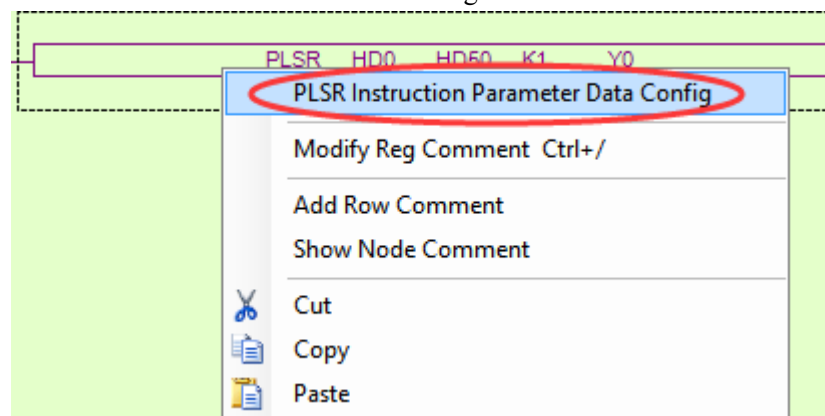

In the open multi-segment pulse output configuration table, select "mode" as "absolute" (default is "relative"), as shown in the following figure:

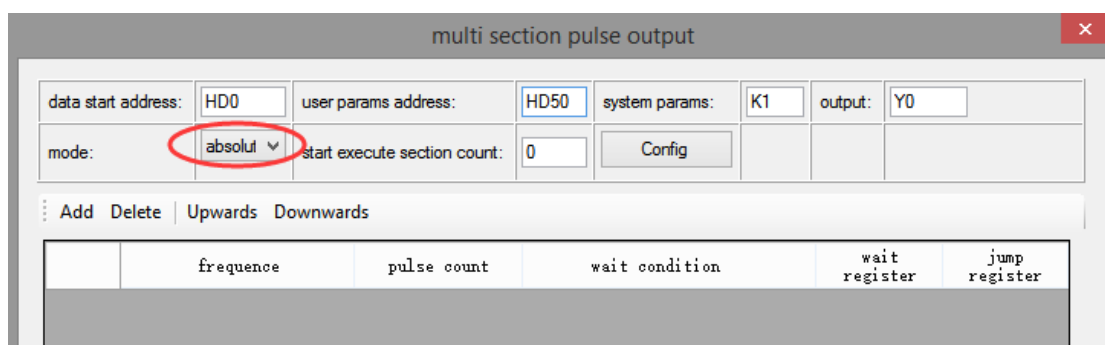

After choosing the mode, click the "Add" button in the configuration interface to add two continuous pulse parameters of forward rotation; after configuring, click the "Write to PLC" button to write parameters into the PLC, as shown in the following figure:

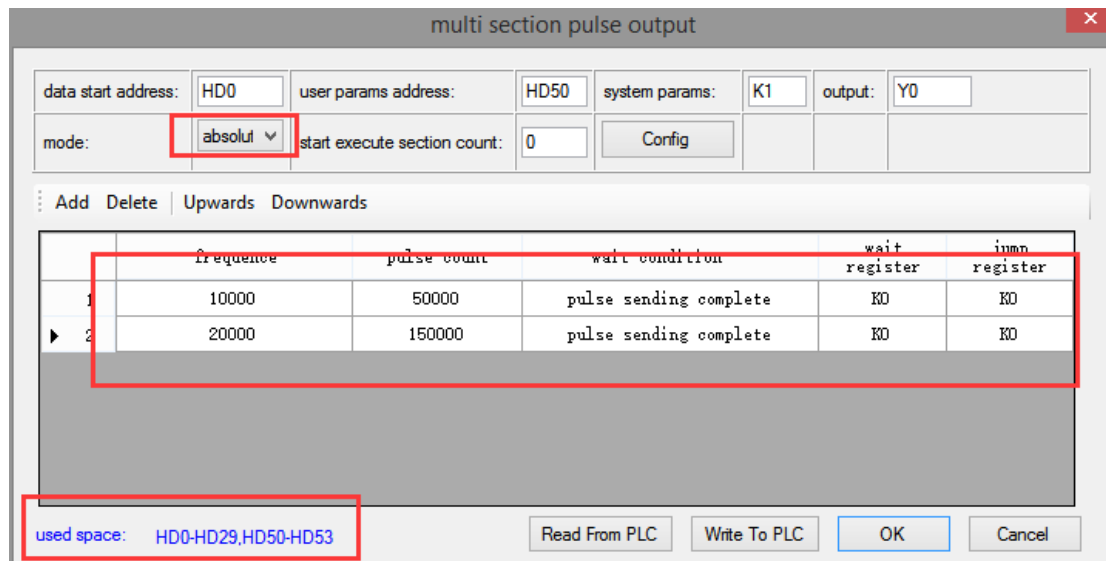

**Note:** Please note the range of real-time occupied registers displayed by "used space". Because the range of starting address of pulse parameter data of PLSR pulse instruction is HD0-HD29, and the range of system parameter block address is HD50-HD53, the range of real-time occupied registers address is not beyond the range. If the range exceeds, the error of pulse output will occur.

Then, right-click on the reverse positioning command PLSR and pop up the following options. Select the first "PLSR Instruction Parameter data Config":

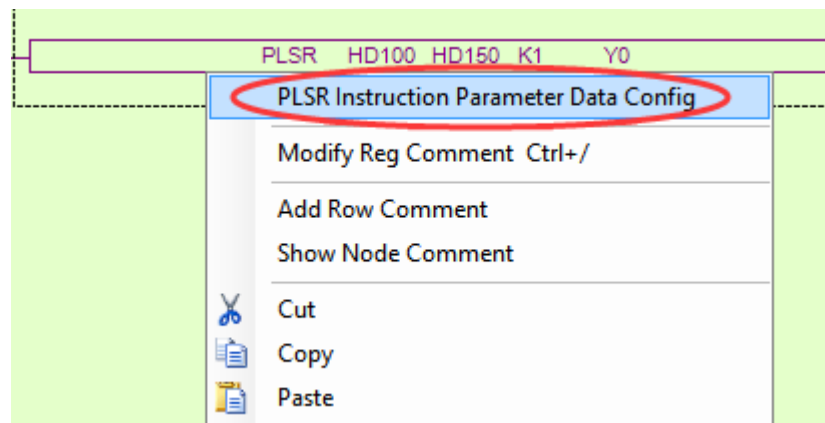

In the open multi-segment pulse output configuration table, select "mode" as "absolute" (default is "relative"), as shown in the following figure:

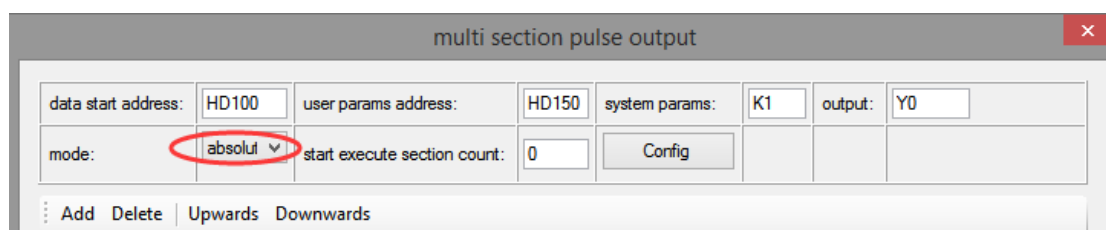

After choosing the mode, click the "Add" button in the configuration interface to add two continuous pulse parameters of forward rotation; after configuring, click the "Write to PLC" button to write parameters into the PLC, as shown in the following figure:

multi section pulse output

data start address: HD100 user params address: HD150 system params: K1 output: Y0

mode: absolute start execute section count: 0 Config

Add Delete Upwards Downwards

	frequence	pulse count	wait condition	wait register	jump register
1	20000	100000	pulse sending complete	K0	K0
▶ 2	10000	100	pulse sending complete	K0	K0

used space: HD100-HD129,HD150-HD153

Read From PLC Write To PLC OK Cancel

**Note:** Please note the range of real-time occupied registers displayed by "used space". Because the range of starting address of pulse parameter data of PLSR pulse instruction is HD100-HD129, and the range of system parameter block address is HD150-HD153, the range of real-time occupied registers address is not beyond the range. If the range exceeds, the error of pulse output will occur.

After downloading the program, power off the PLC and then re-energize it.

Positive Limit (X11) and Negative Limit (X12) will play an important role in the execution of ZRN, PLSF, DRVI and DRVA instructions.

**Example 2: According to the following figure, multi-segment absolute positioning mode is adopted.**

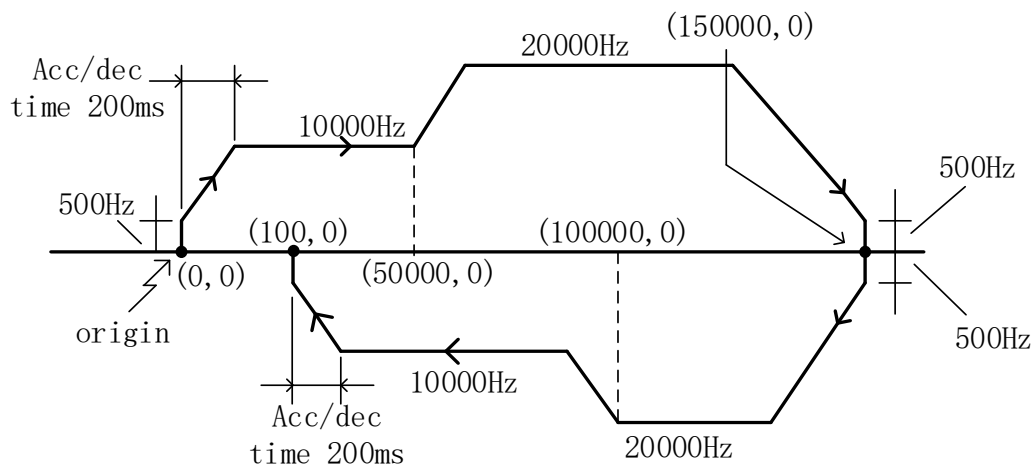

Firstly, make the ladder chart as follows:



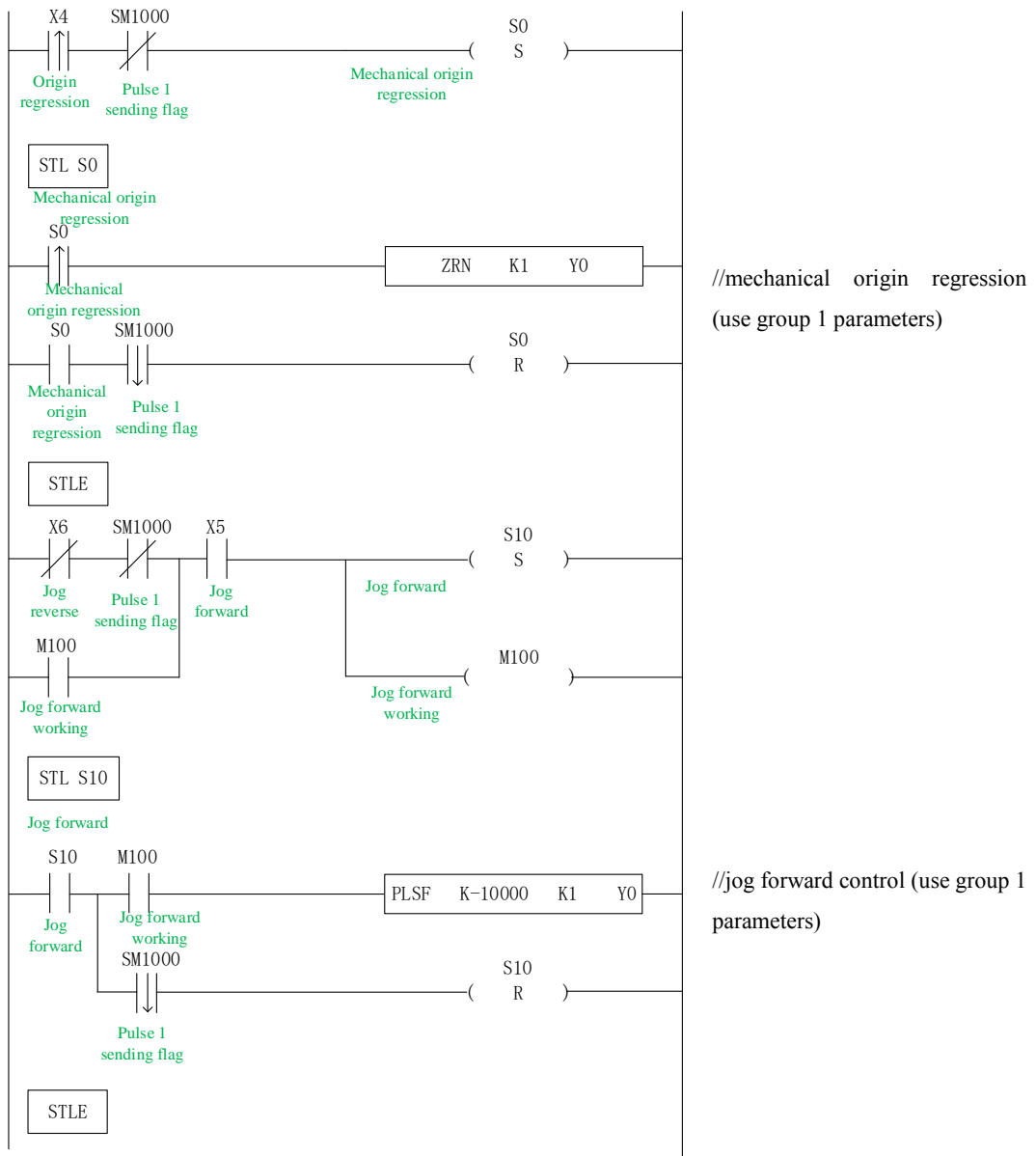

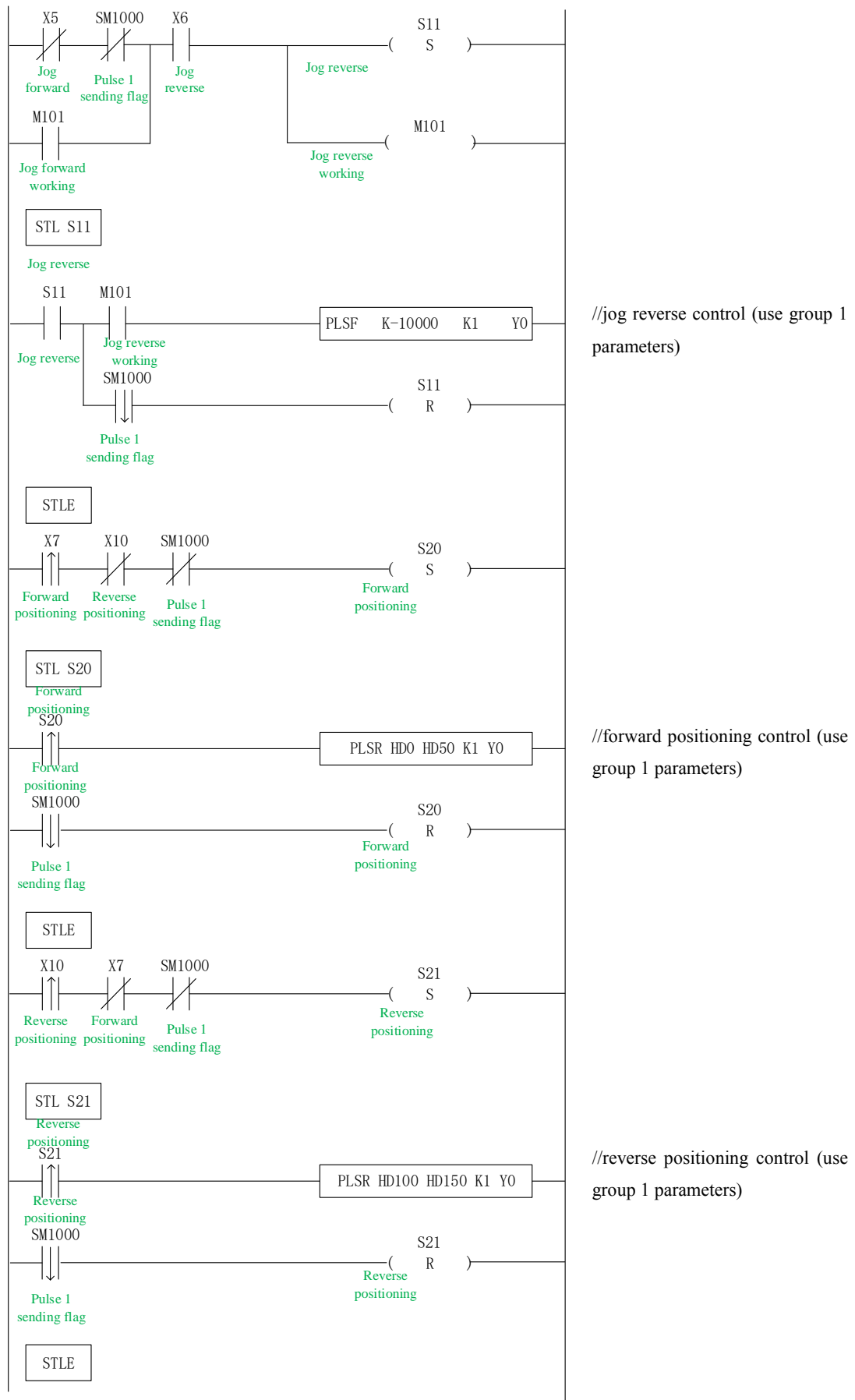

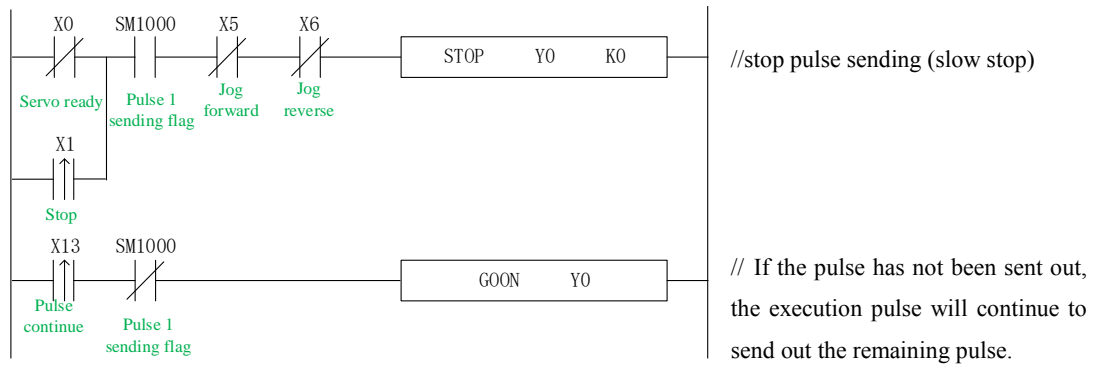

In the sample program, all the system parameters used in the pulse instructions are group 1 parameters. So, we click "pulse configuration parameters" in the PLC programming software, as follows:

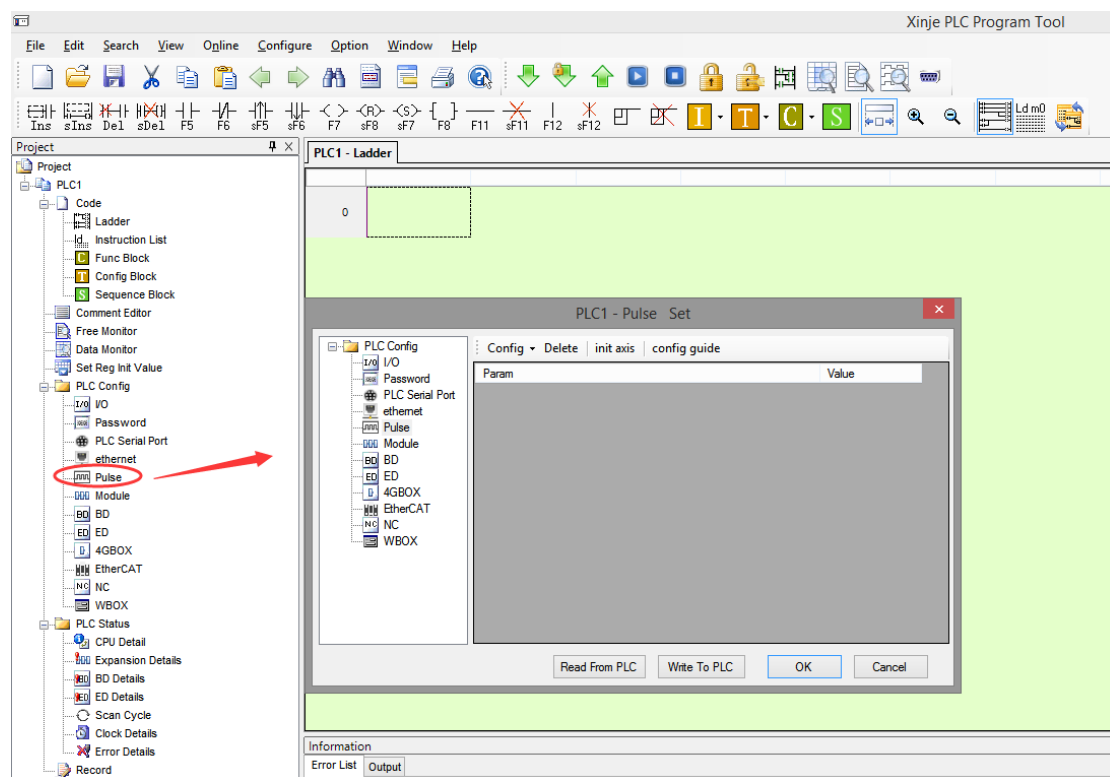

Click config, then select Y0 axis.

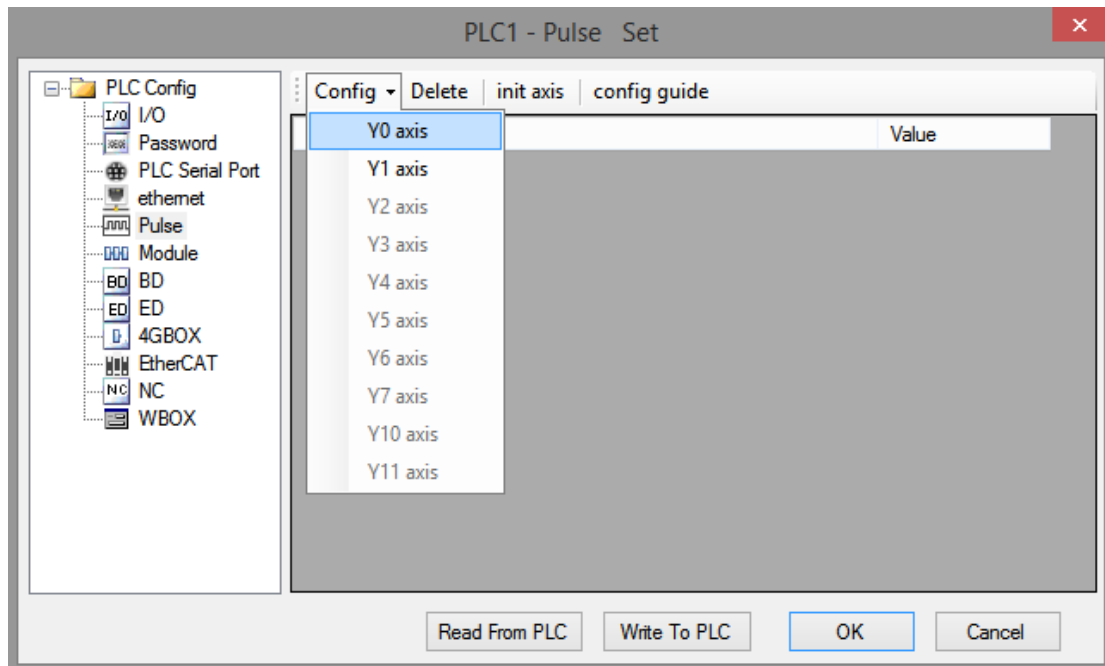

In the parameter configuration table, configure as follows (circled parameters need to be modified):

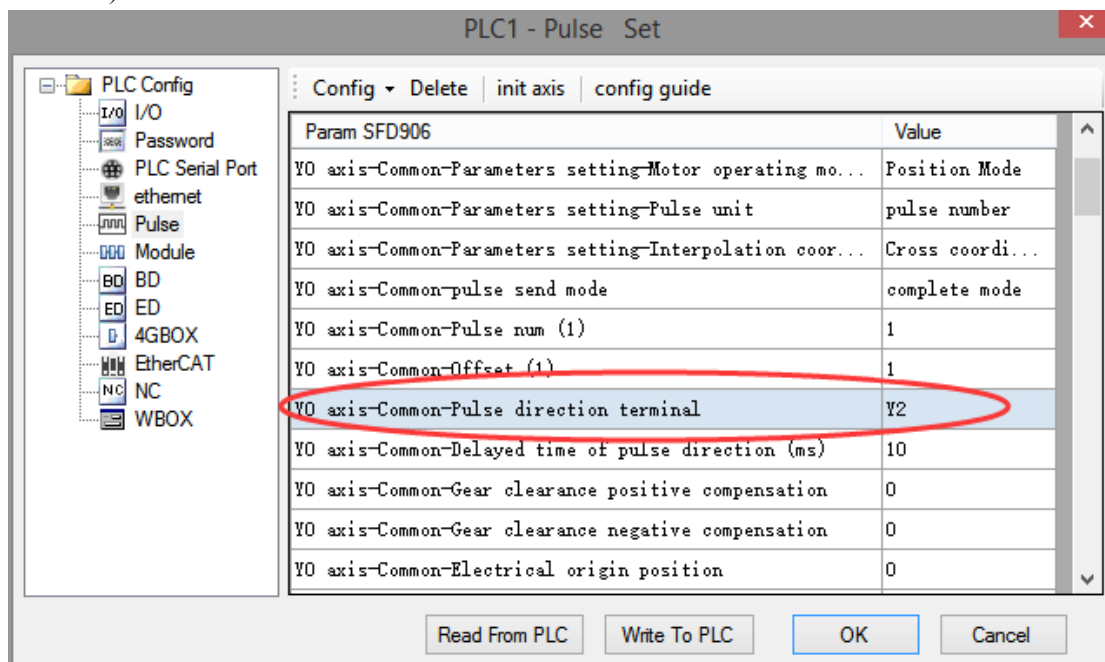

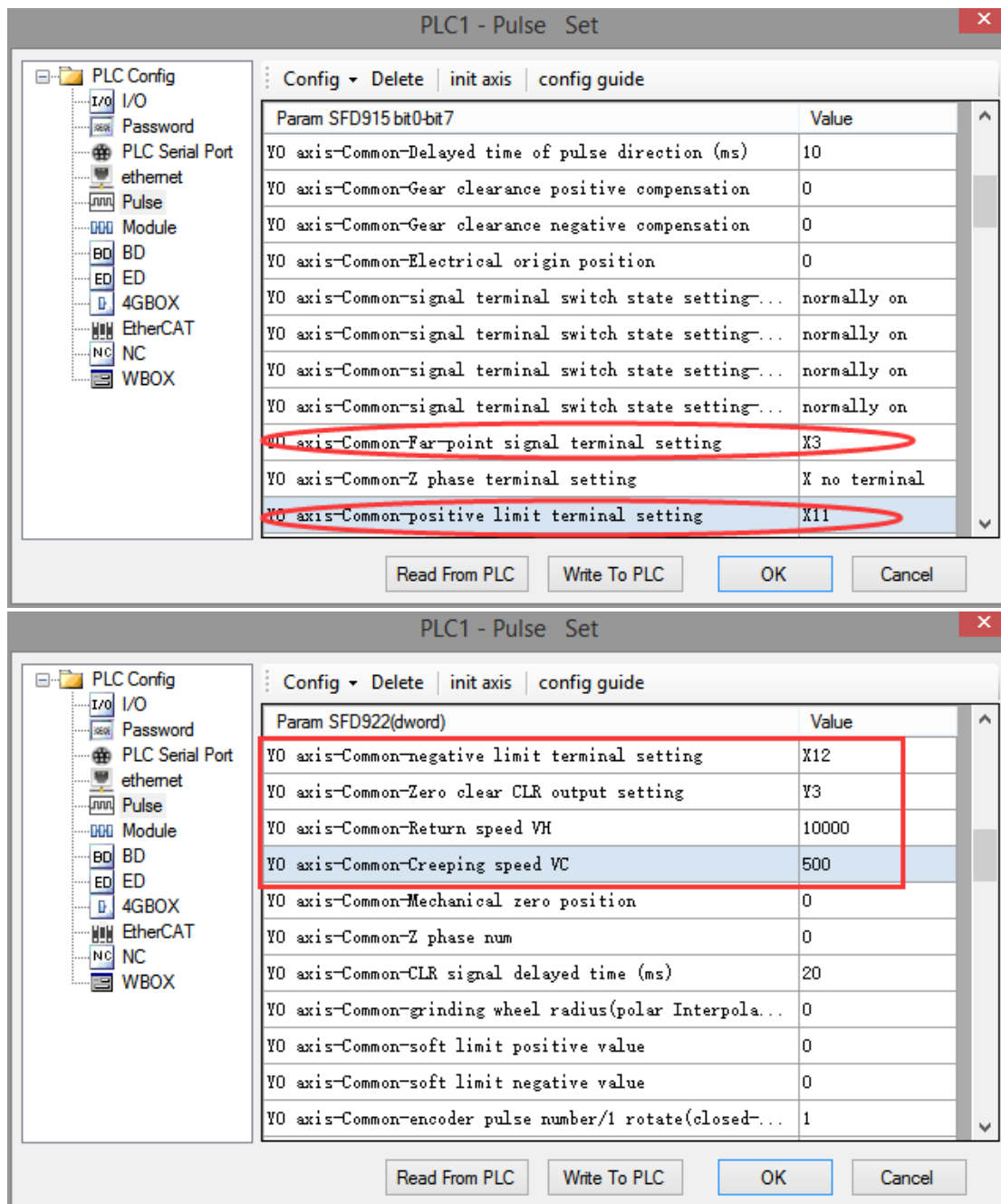

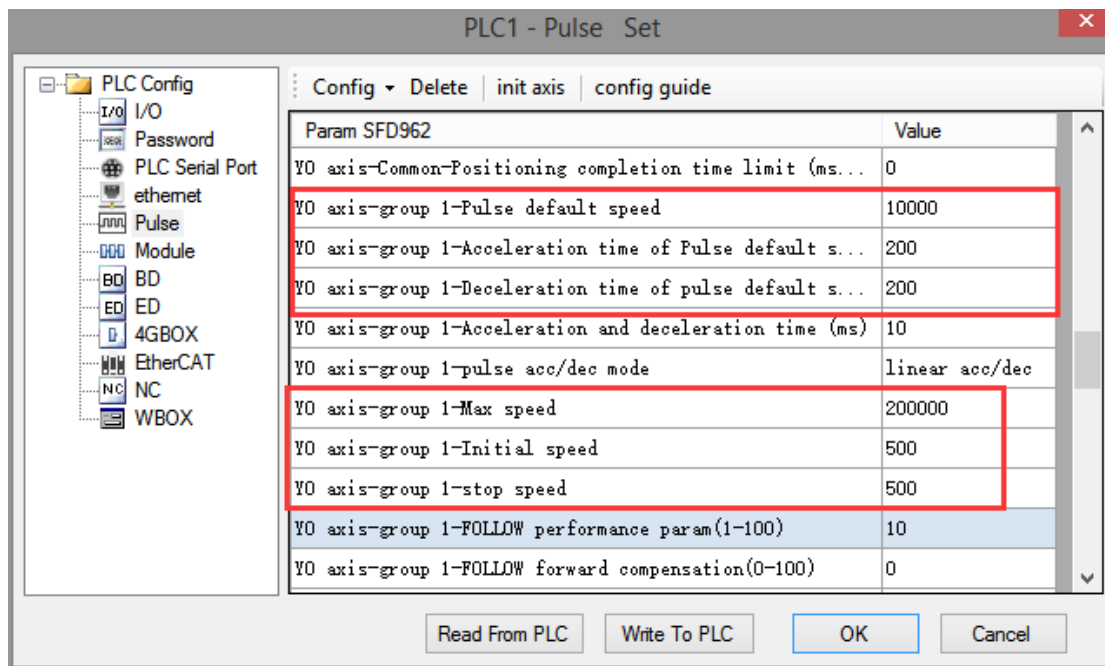

After configuring the parameters of the system parameter block, click the "Write to PLC" button to write the parameters into the PLC. Since the PLSR is used as the multi-segment pulse output instruction, we also need to configure the parameters of the pulse segment (the output frequency and the number of pulses per pulse segment).

Firstly, right-click on the forward positioning command PLSR and pop up the following options. Select the first "PLSR Instruction Parameter data Config":

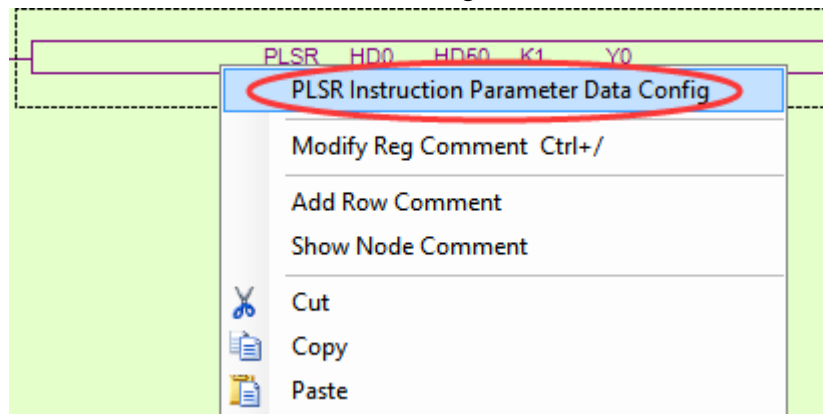

In the open multi-segment pulse output configuration table, select "mode" as "relative" (default is "relative"), as shown in the following figure:

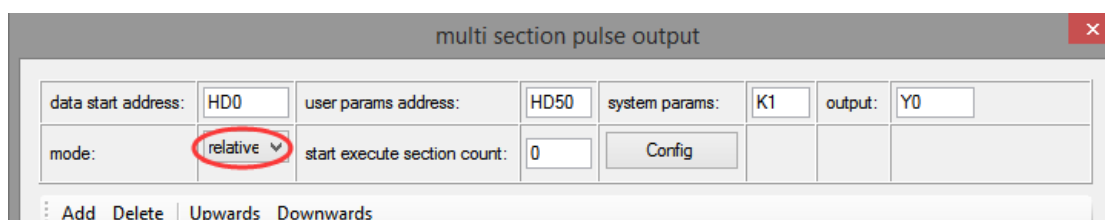

After choosing the mode, click the "Add" button in the configuration interface to add two continuous pulse parameters of forward rotation; after configuring, click the "Write to PLC" button to write parameters into the PLC, as shown in the following figure:

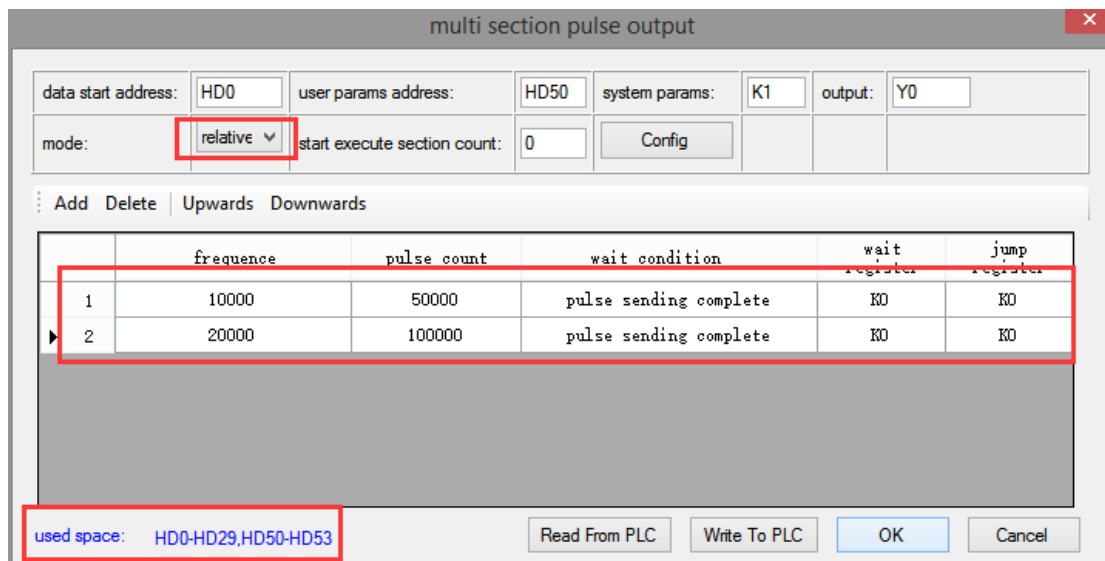

**Note:** Please note the range of real-time occupied registers displayed by "used space". Because the range of starting address of pulse parameter data of PLSR pulse instruction is HD0-HD29, and the range of system parameter block address is HD50-HD53, the range of real-time occupied registers address is not beyond the range. If the range exceeds, the error of pulse output will occur.

Then, right-click on the reverse positioning command PLSR and pop up the following options. Select the first "PLSR Instruction Parameter data Config":

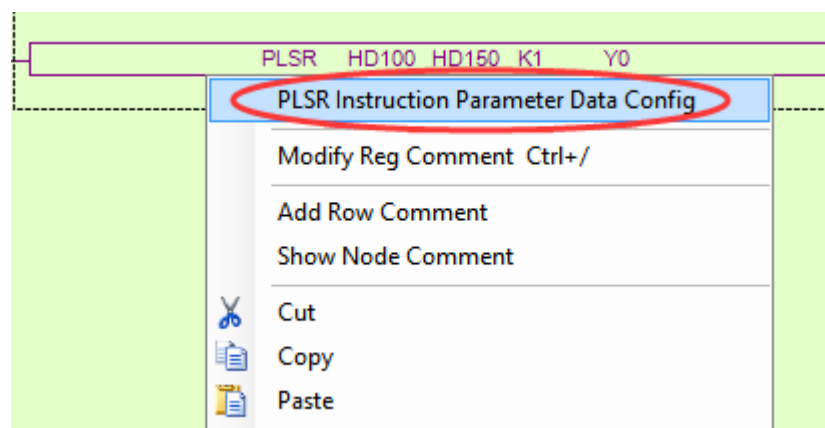

In the open multi-segment pulse output configuration table, select "mode" as "relative" (default is "relative"), as shown in the following figure:

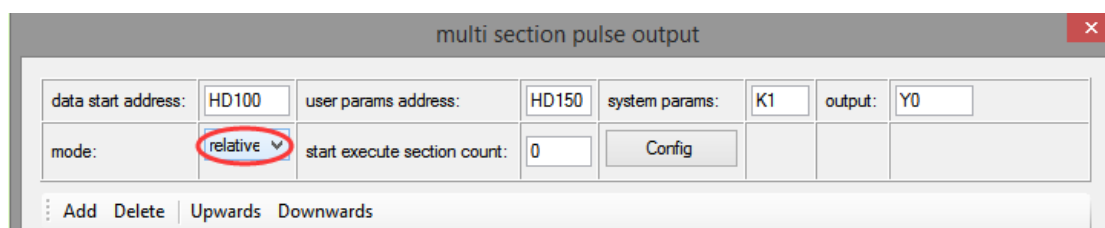

After choosing the mode, click the "Add" button in the configuration interface to add two continuous pulse parameters of reverse rotation; after configuring, click the "Write to PLC" button to write parameters into the PLC, as shown in the following figure:

multi section pulse output

data start address: HD100 user params address: HD150 system params: K1 output: Y0

mode: relative start execute section count: 0 Config

Add Delete Upwards Downwards

	frequency	pulse count	wait condition	wait register	jump register
1	20000	-50000	pulse sending complete	K0	K0
2	10000	-99900	pulse sending complete	K0	K0

used space: HD100-HD129,HD150-HD153 Read From PLC Write To PLC OK Cancel

**Note:** Please note the range of real-time occupied registers displayed by "used space". Because the range of starting address of pulse parameter data of PLSR pulse instruction is HD100-HD129, and the range of system parameter block address is HD150-HD153, the range of real-time occupied registers address is not beyond the range. If the range exceeds, the error of pulse output will occur.

After downloading the program, power off the PLC and then re-energize it.

Positive Limit (X11) and Negative Limit (X12) will play an important role in the execution of ZRN, PLSF, DRVI and DRVA instructions.



**1-5-6. Forward reverse rotation multi-segment sequential control program  
【DRVI, DRVA, PLSR, ZRN】**

**Example 1: According to the following figure, multi-segment absolute positioning mode is adopted.**

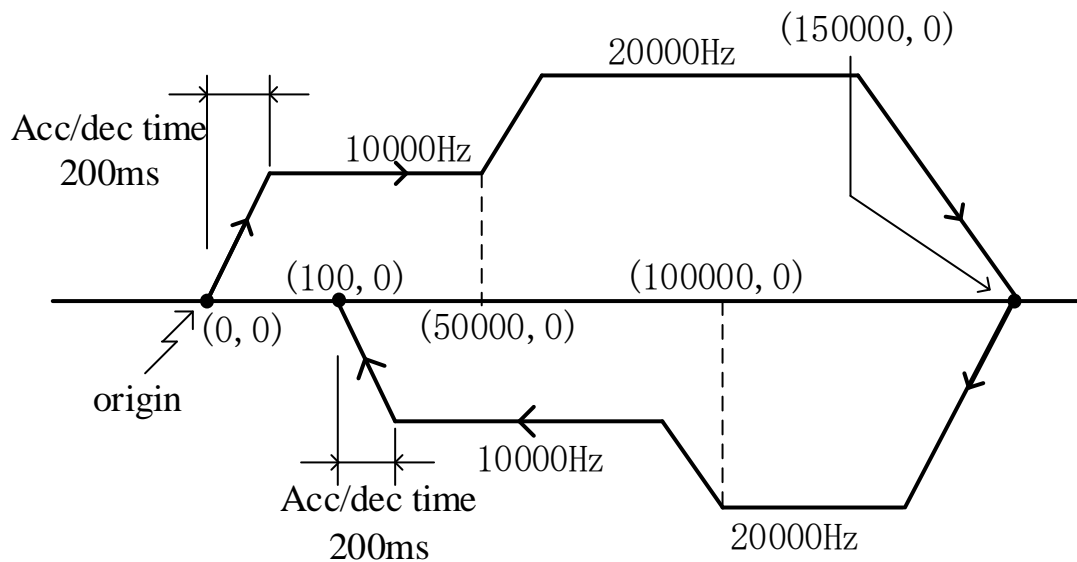

Firstly, make the ladder chart as follows:

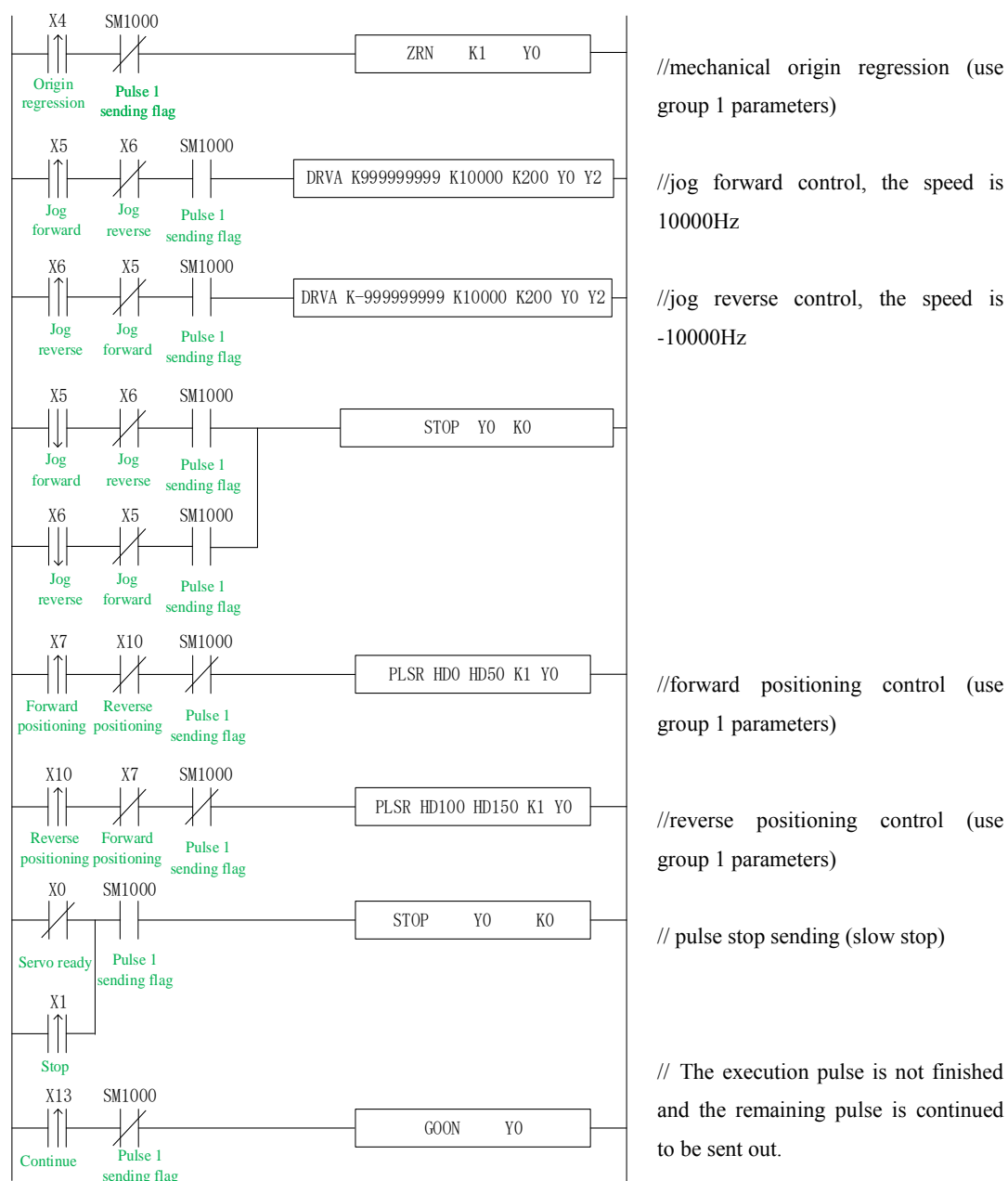

In the sample program, all the system parameters used in the pulse instructions (except DRVA, DRVI) are group 1 parameters. So, we click "pulse configuration parameters" in the PLC programming software, as follows:

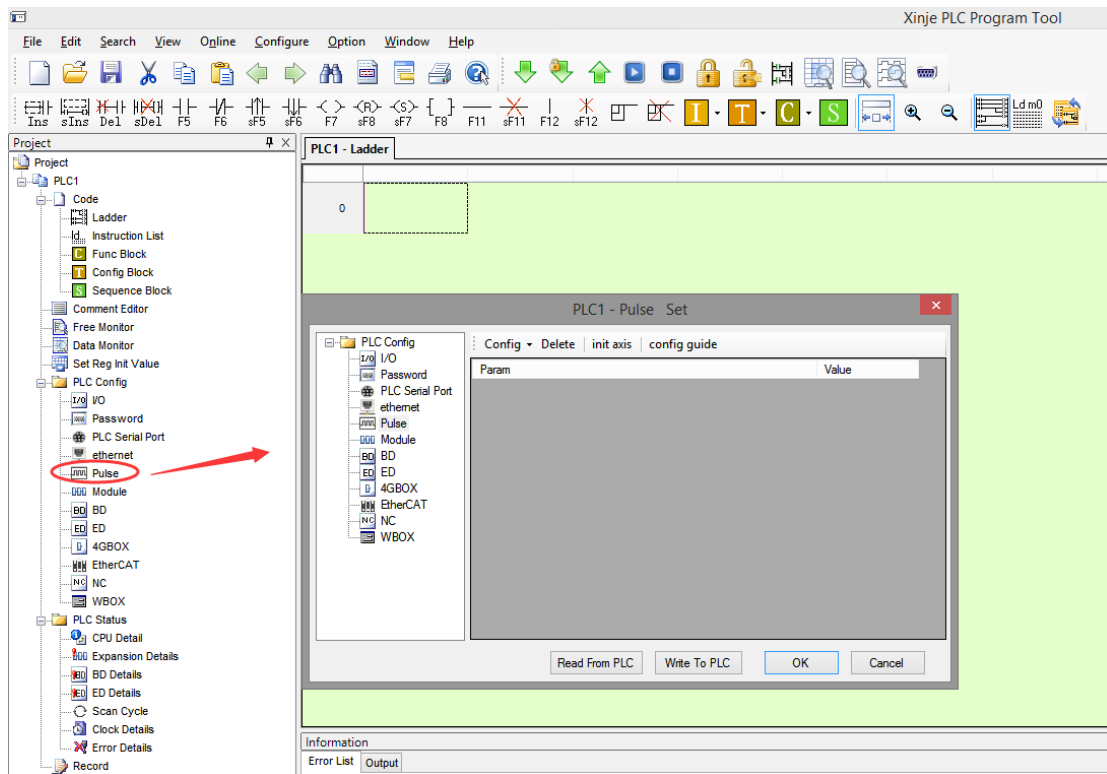

Click config, then select Y0 axis.

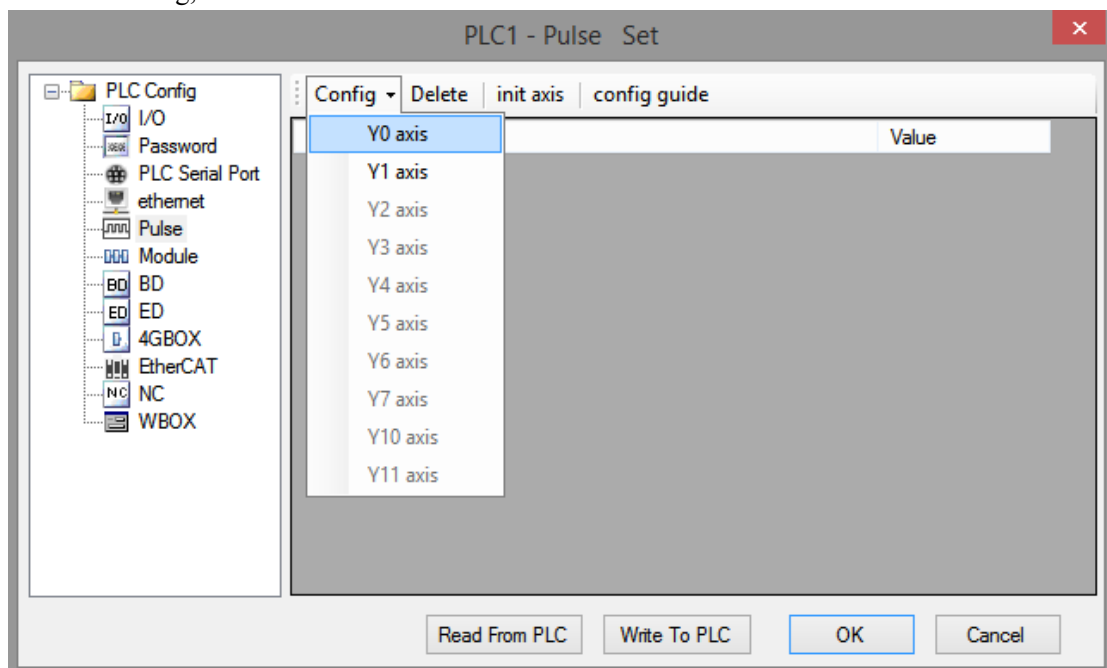

In the parameter configuration table, configure as follows (circled parameters need to be modified):

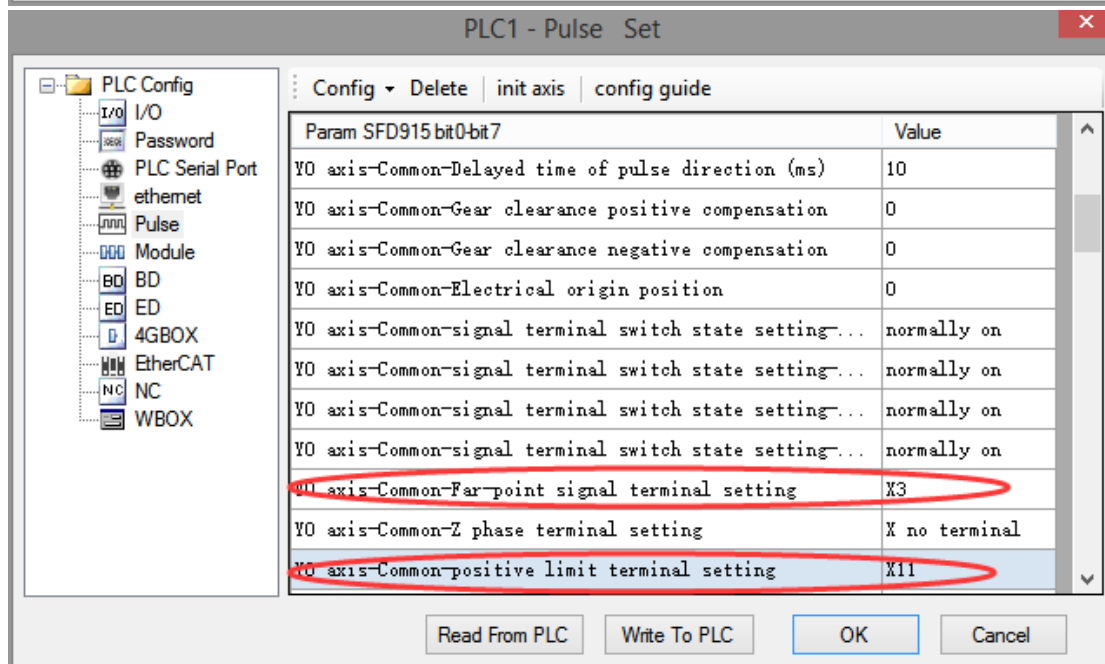
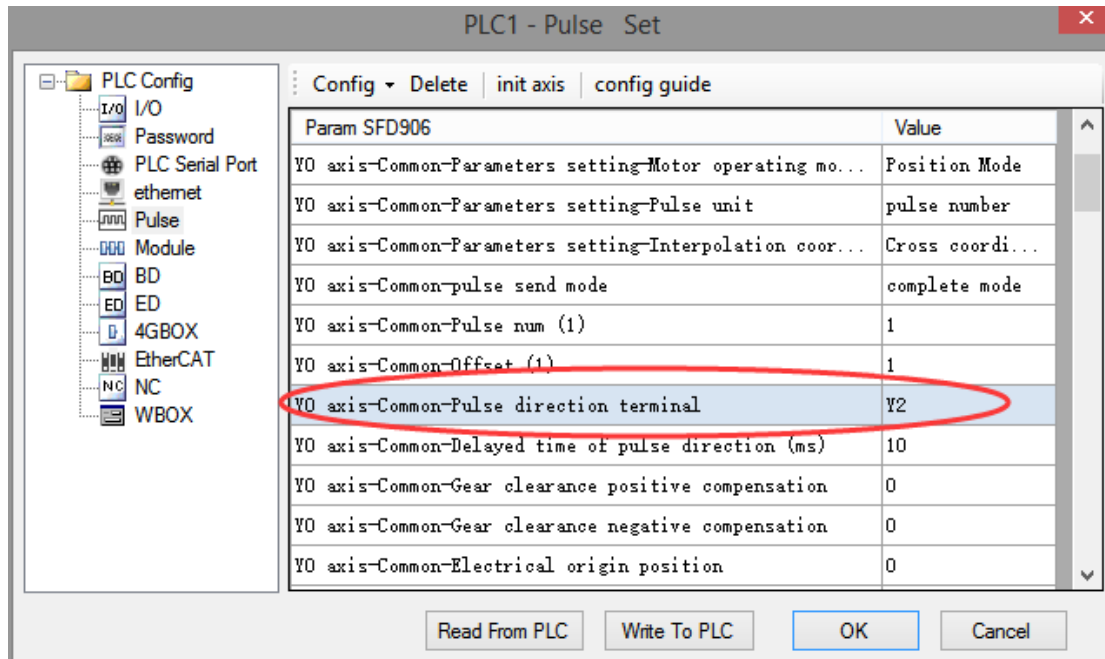

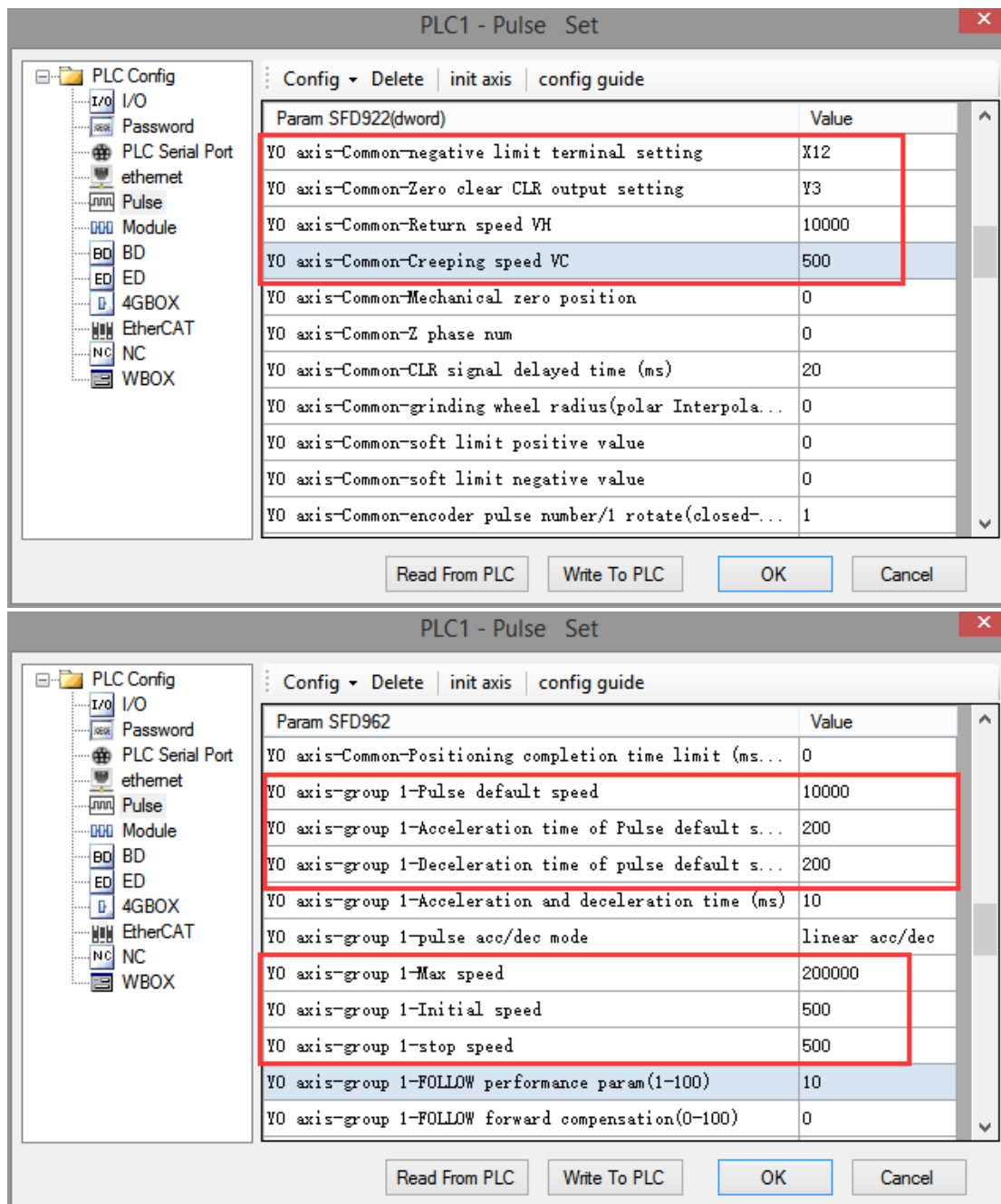

After configuring the parameters of the system parameter block, click the "Write to PLC" button to write the parameters into the PLC. Since the PLSR is used as the multi-segment pulse output instruction, we also need to configure the parameters of the pulse segment (the output frequency and the number of pulses per pulse segment).

Firstly, right-click on the forward positioning command PLSR and pop up the following options. Select the first "PLSR Instruction Parameter data Config":

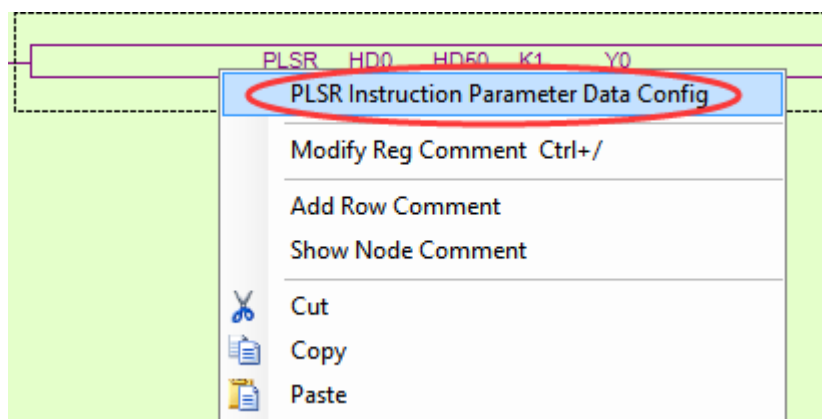

In the open multi-segment pulse output configuration table, select "mode" as "absolute" (default is "relative"), as shown in the following figure:

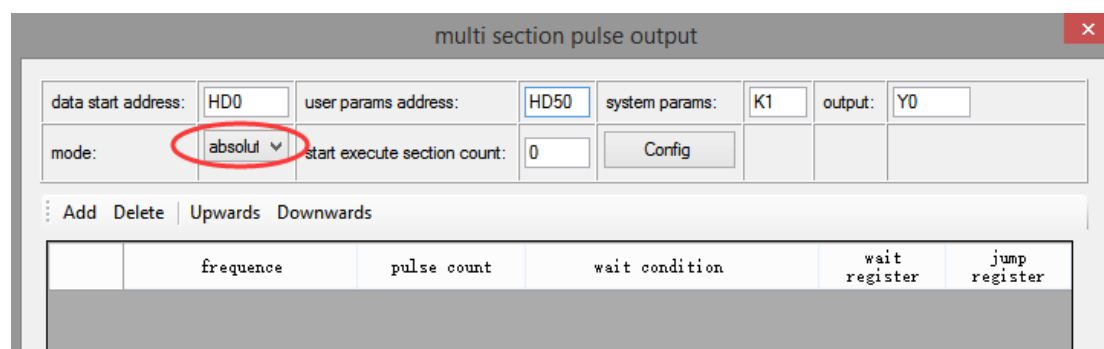

After choosing the mode, click the "Add" button in the configuration interface to add two continuous pulse parameters of forward rotation; after configuring, click the "Write to PLC" button to write parameters into the PLC, as shown in the following figure:

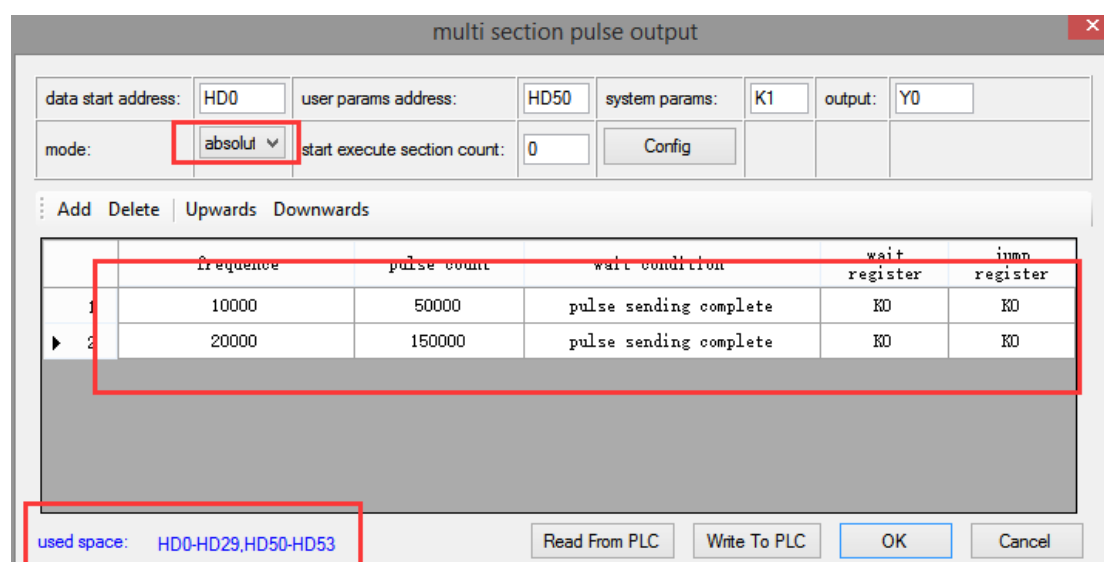

**Note:** Please note the range of real-time occupied registers displayed by "used space". Because the range of starting address of pulse parameter data of PLSR pulse instruction is HD0-HD29, and the range of system parameter block address is HD50-HD53, the range of real-time occupied registers address is not beyond the range. If the range exceeds, the error of pulse output will occur.

Then, right-click on the reverse positioning command PLSR and pop up the following options. Select the first "PLSR Instruction Parameter data Config":

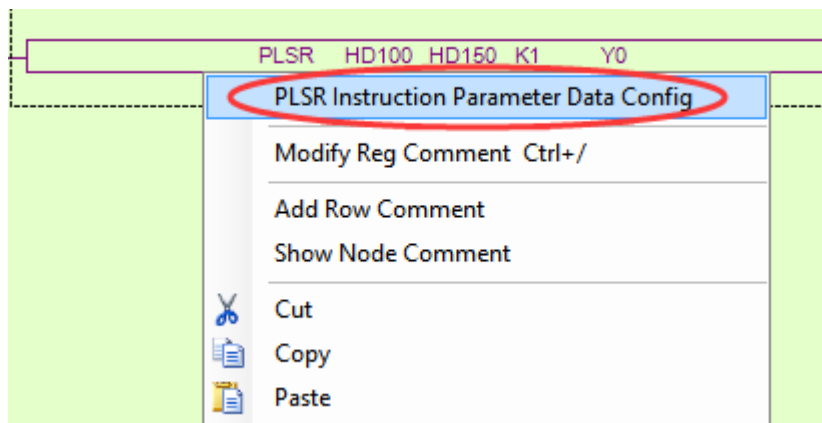

In the open multi-segment pulse output configuration table, select "mode" as "absolute" (default is "relative"), as shown in the following figure:

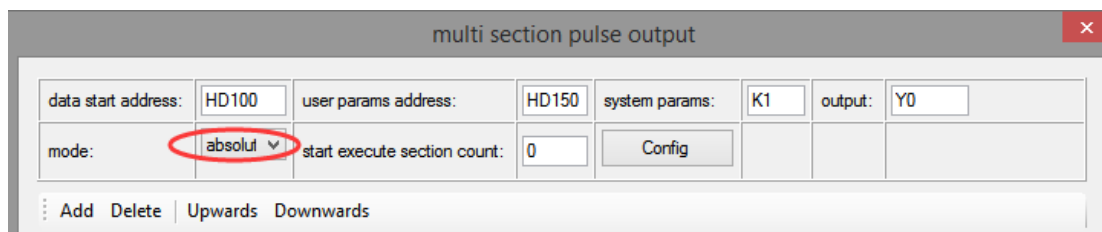

After choosing the mode, click the "Add" button in the configuration interface to add two continuous pulse parameters of forward rotation; after configuring, click the "Write to PLC" button to write parameters into the PLC, as shown in the following figure:

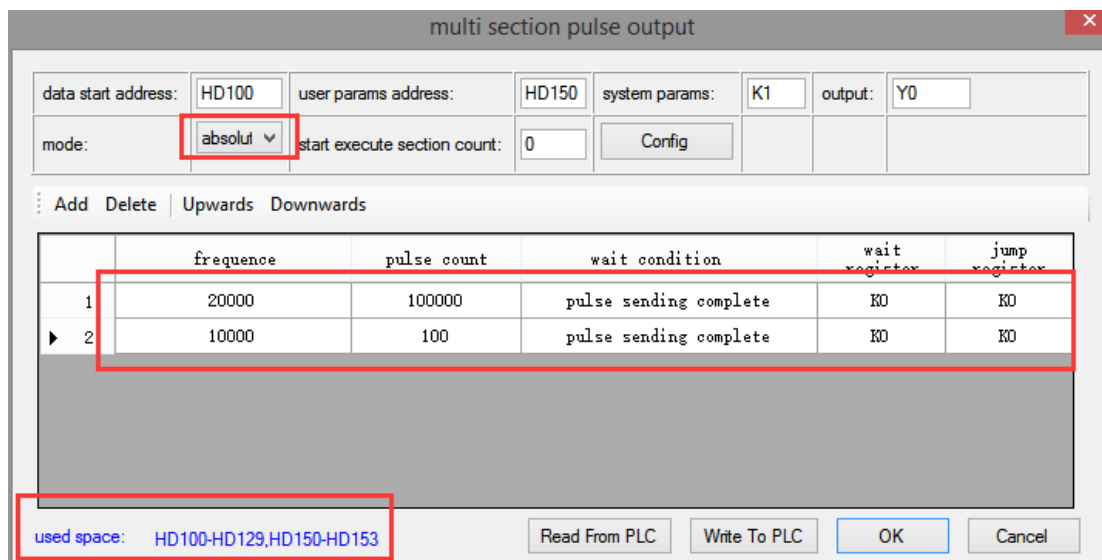

**Note:** Please note the range of real-time occupied registers displayed by "used space". Because the range of starting address of pulse parameter data of PLSR pulse instruction is HD100-HD129, and the range of system parameter block address is HD150-HD153, the range of real-time occupied registers address is not beyond the range. If the range exceeds, the error of pulse output will occur.

After downloading the program, power off the PLC and then re-energize it. Positive Limit (X11) and Negative Limit (X12) will play an important role in the execution of ZRN, PLSF, DRVI and DRVA instructions.

**Example 2: According to the following figure, the relative multi-segment pulse positioning method is used.**

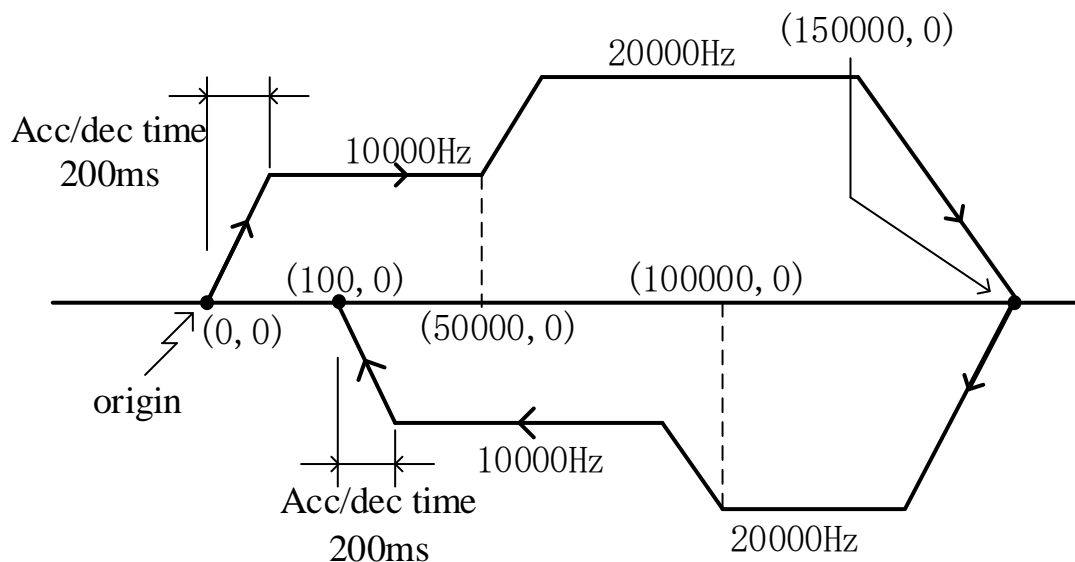

Firstly, make the ladder chart as the follows:



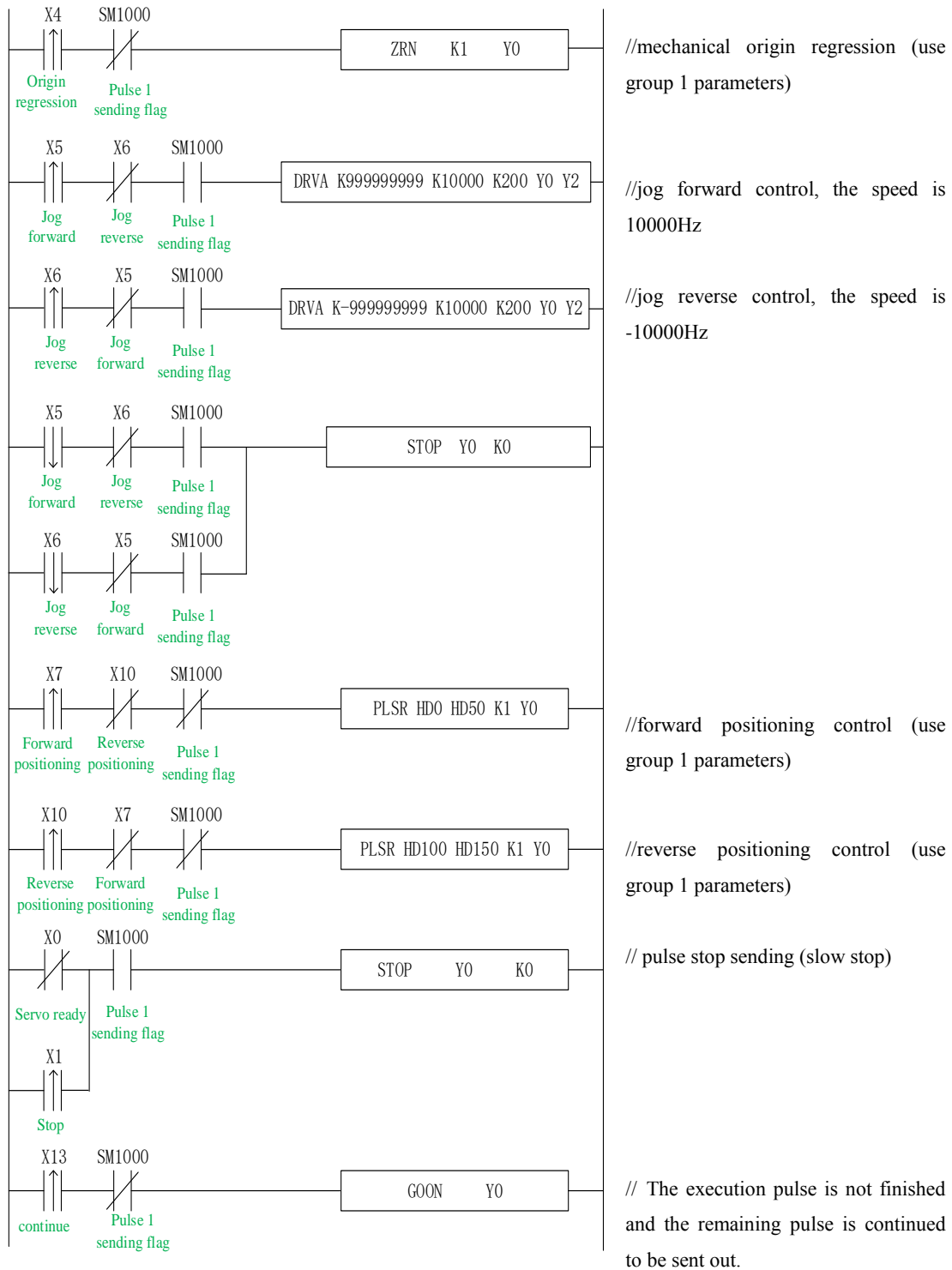

In the sample program, all the system parameters used in the pulse instructions (except DRVA, DRVI) are group 1 parameters. So, we click "pulse configuration parameters" in the PLC programming software, as follows:

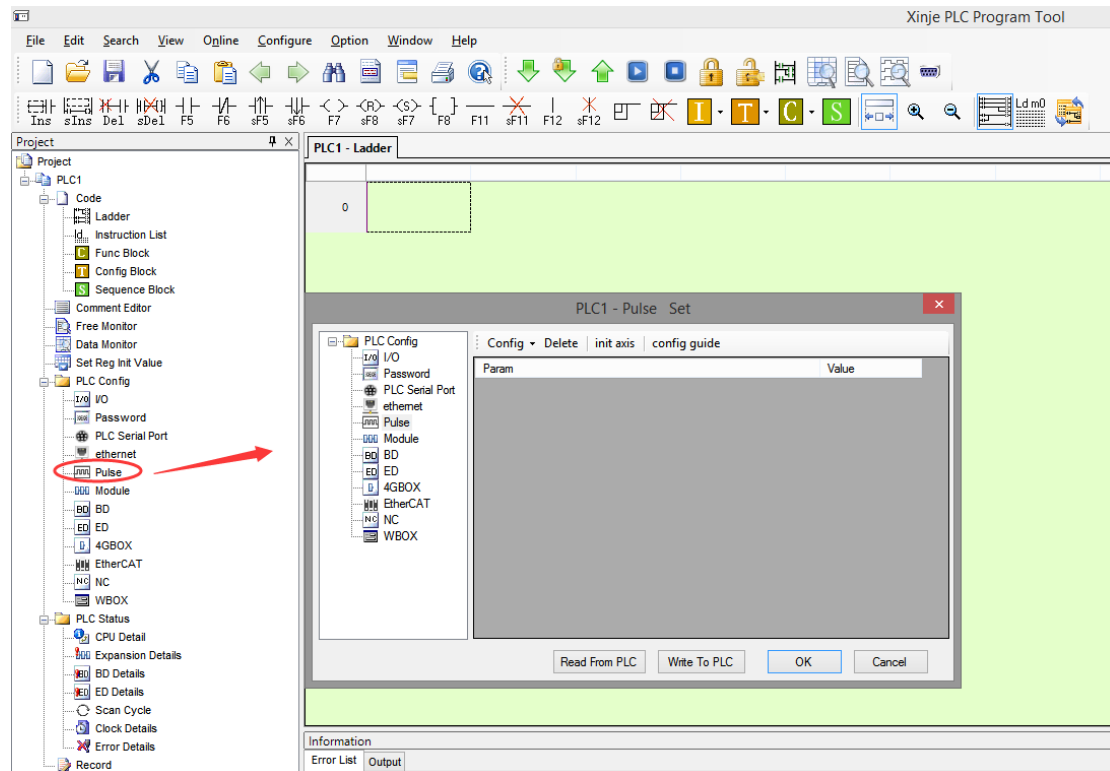

Click config, then select Y0 axis.

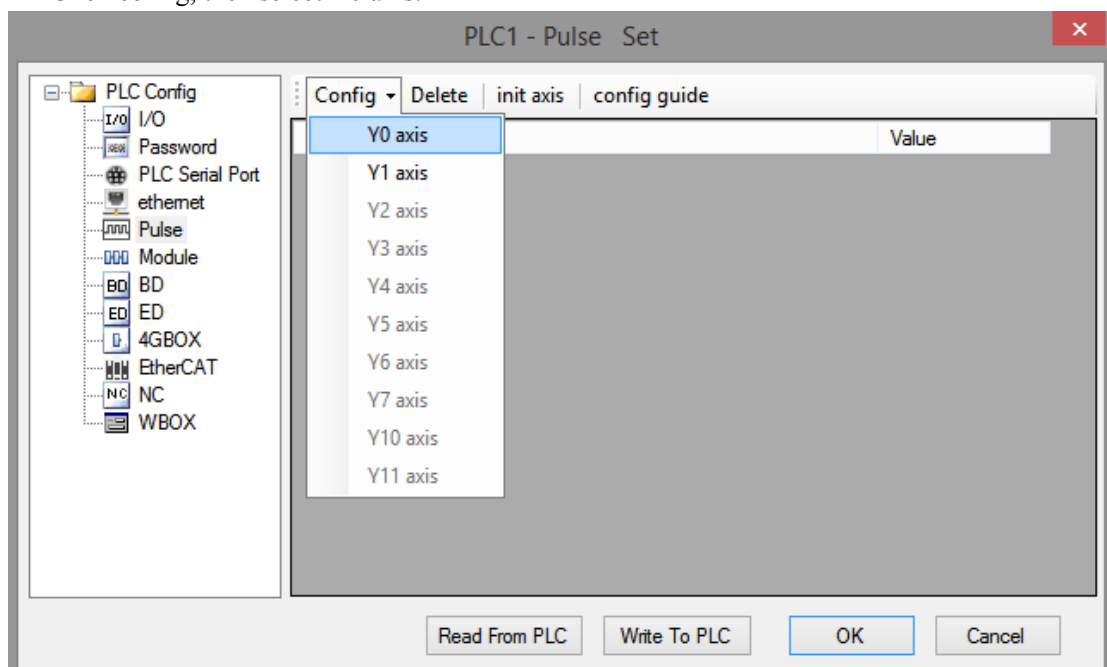

In the parameter configuration table, configure as follows (circled parameters need to be modified):

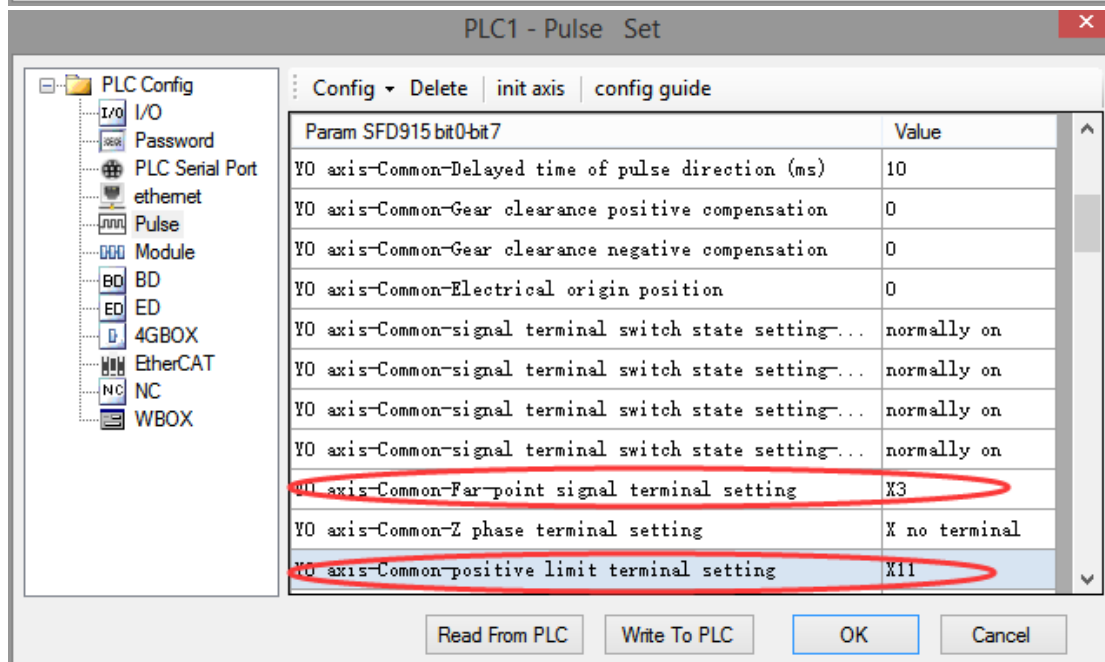
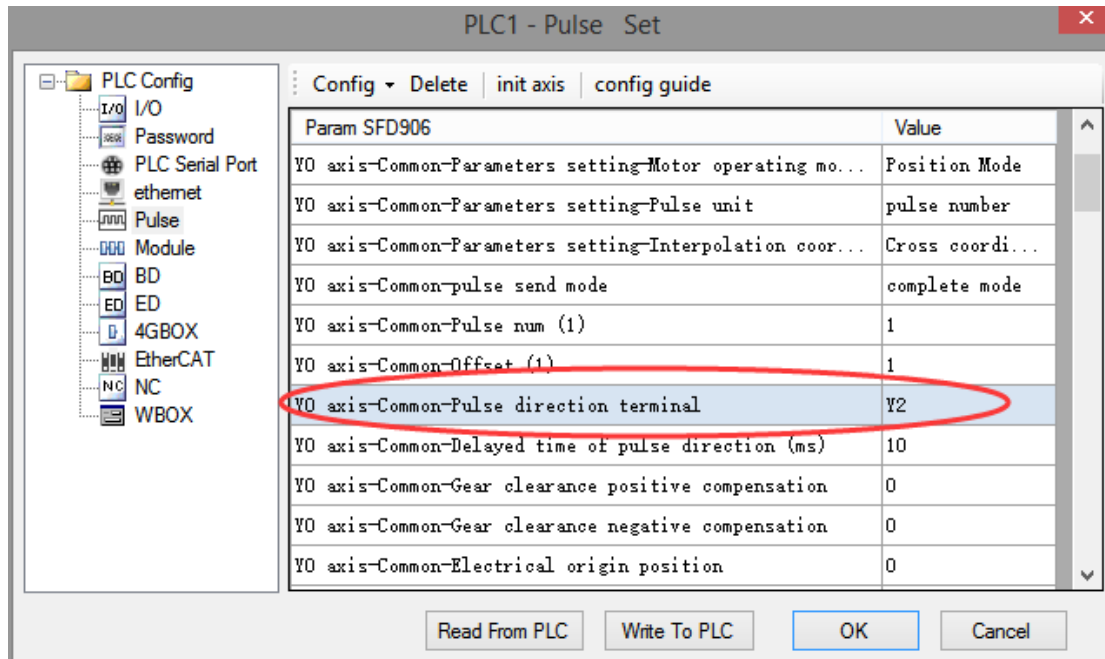

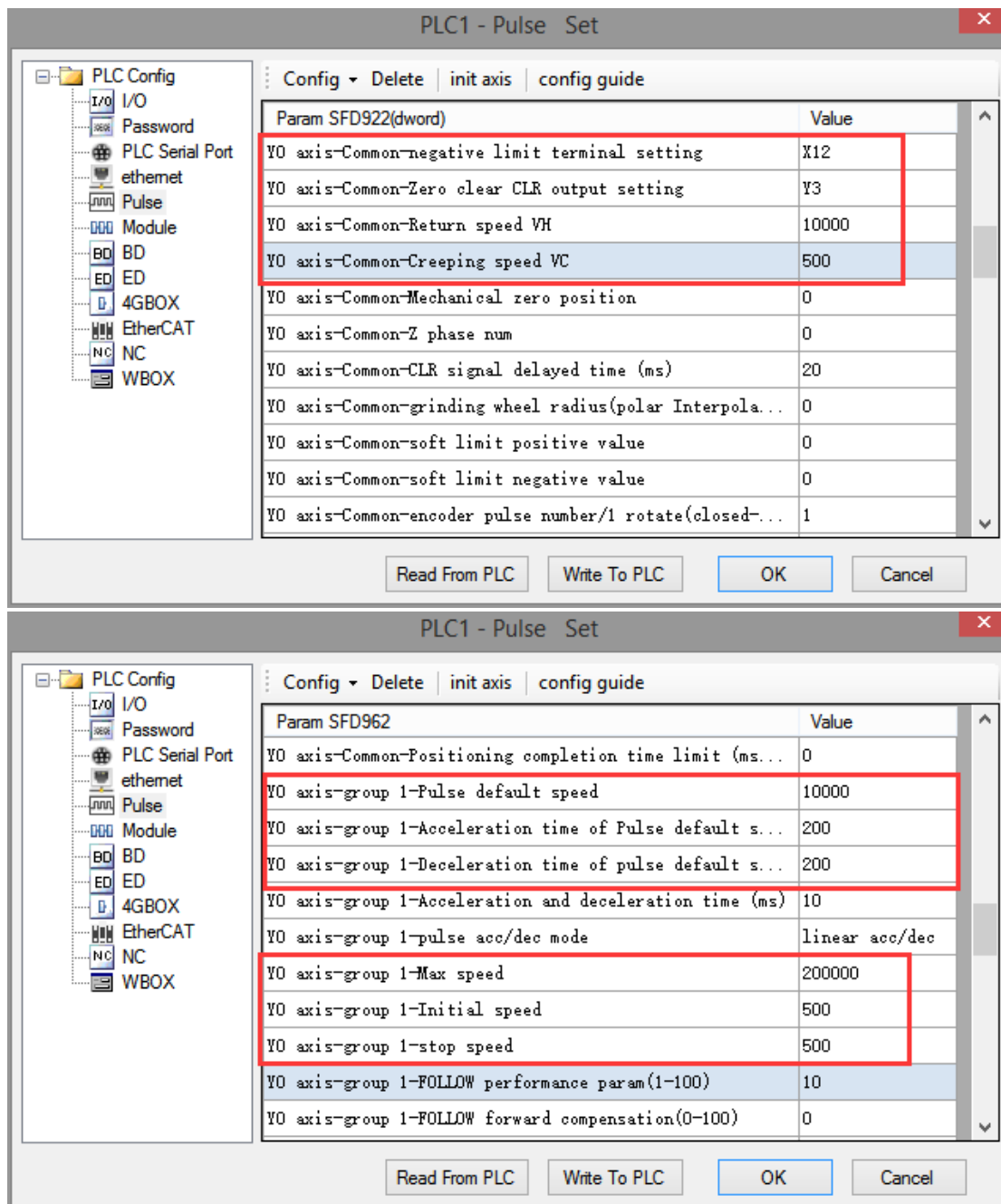

After configuring the parameters of the system parameter block, click the "Write to PLC" button to write the parameters into the PLC. Since the PLSR is used as the multi-segment pulse output instruction, we also need to configure the parameters of the pulse segment (the output frequency and the number of pulses per pulse segment).

Firstly, right-click on the forward positioning command PLSR and pop up the following options. Select the first "PLSR Instruction Parameter data Config":

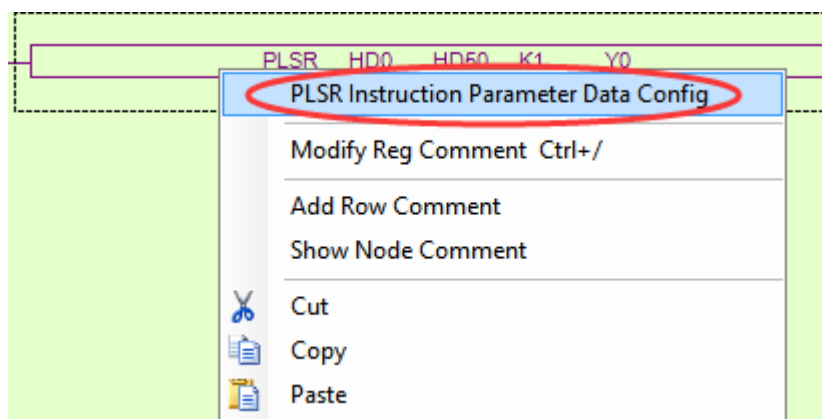

In the open multi-segment pulse output configuration table, select "mode" as "relative" (default is "relative"), as shown in the following figure:

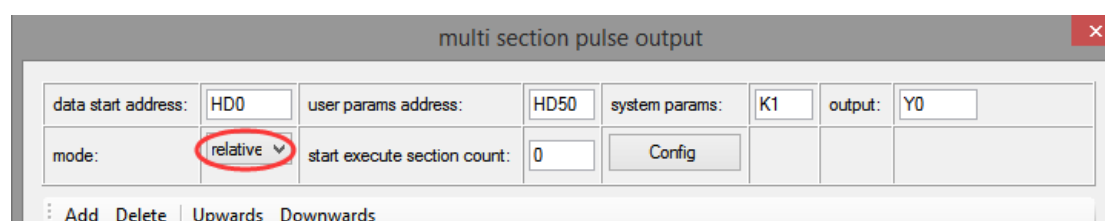

After choosing the mode, click the "Add" button in the configuration interface to add two continuous pulse parameters of forward rotation; after configuring, click the "Write to PLC" button to write parameters into the PLC, as shown in the following figure:

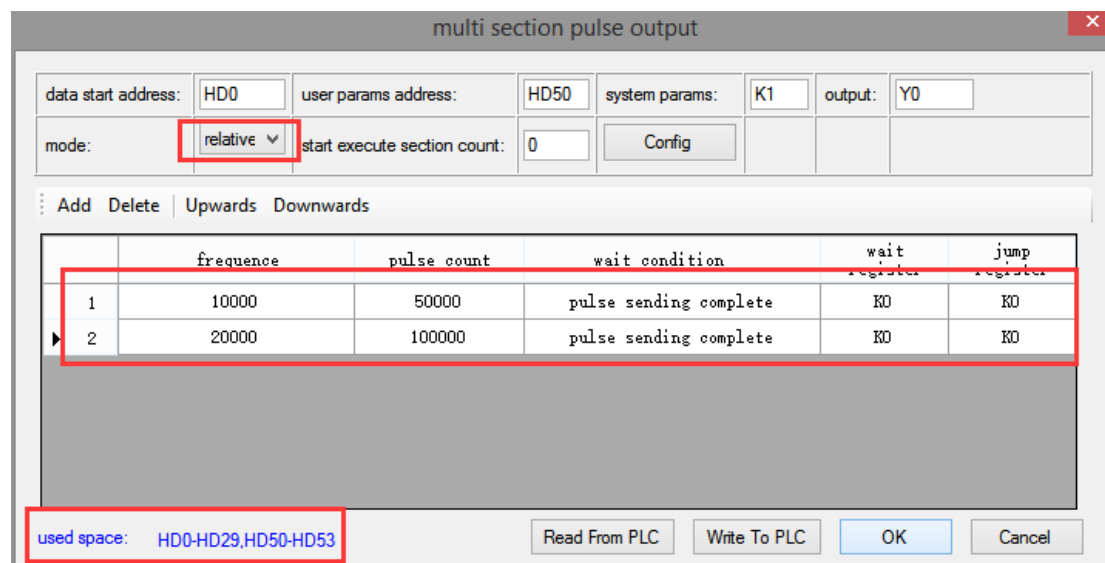

**Note: Please note the range of real-time occupied registers displayed by "used space". Because the range of starting address of pulse parameter data of PLSR pulse instruction is HD0-HD29, and the range of system parameter block address is HD50-HD53, the range of real-time occupied registers address is not beyond the range. If the range exceeds, the error of pulse output will occur.**

Then, right-click on the reverse positioning command PLSR and pop up the following options. Select the first "PLSR Instruction Parameter data Config":

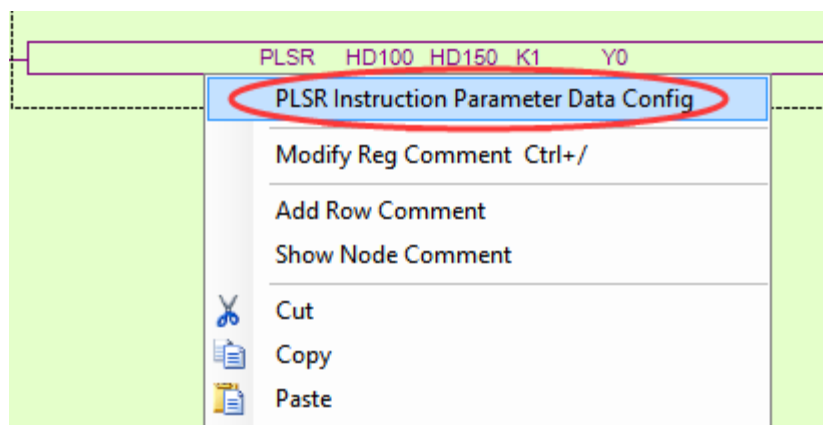

In the open multi-segment pulse output configuration table, select "mode" as "relative" (default is "relative"), as shown in the following figure:

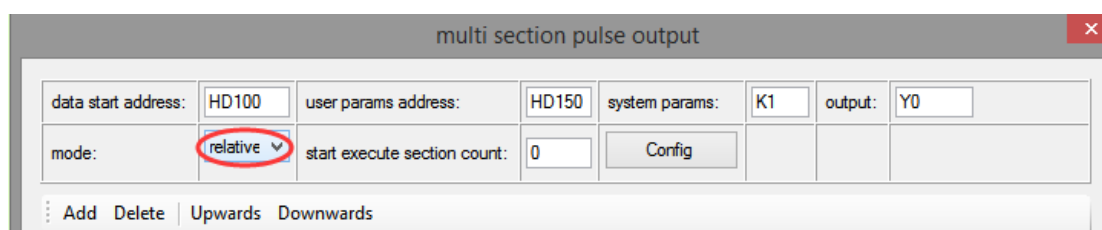

After choosing the mode, click the "Add" button in the configuration interface to add two continuous pulse parameters of reverse rotation; after configuring, click the "Write to PLC" button to write parameters into the PLC, as shown in the following figure:

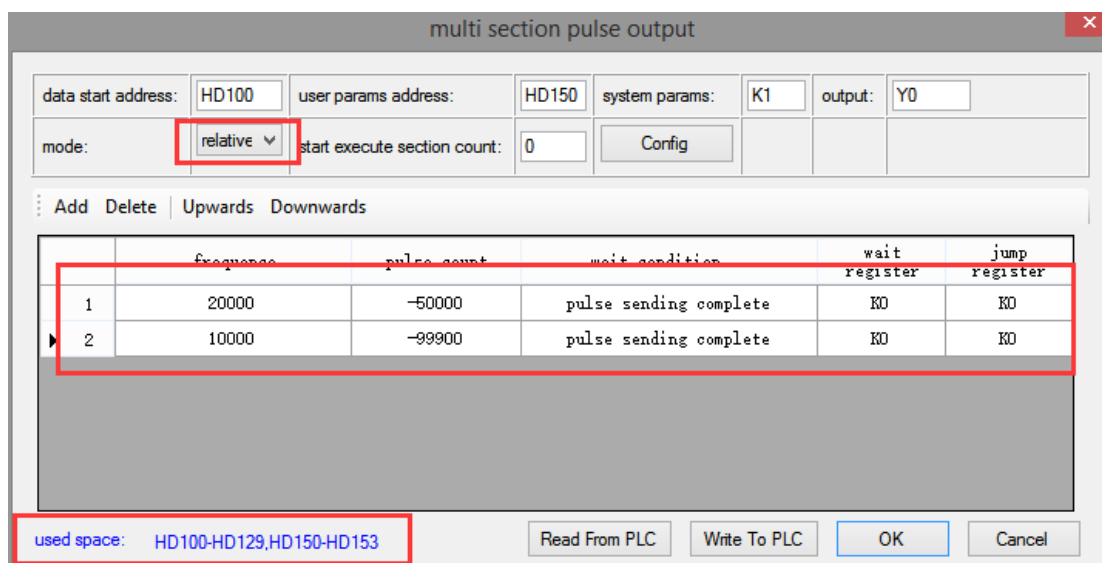

**Note:** Please note the range of real-time occupied registers displayed by "used space". Because the range of starting address of pulse parameter data of PLSR pulse instruction is HD100-HD129, and the range of system parameter block address is HD150-HD153, the range of real-time occupied registers address is not beyond the range. If the range exceeds, the error of pulse output will occur.

After downloading the program, power off the PLC and then re-energize it.

Positive Limit (X11) and Negative Limit (X12) will play an important role in the execution of

ZRN, PLSF, DRVI and DRVA instructions.

**1-5-7. Forward and reverse rotation multi-segment process program  
【DRVI, DRVA, PLSR, ZRN】**

**Example 1: According to the following figure, multi-segment absolute positioning mode is adopted.**

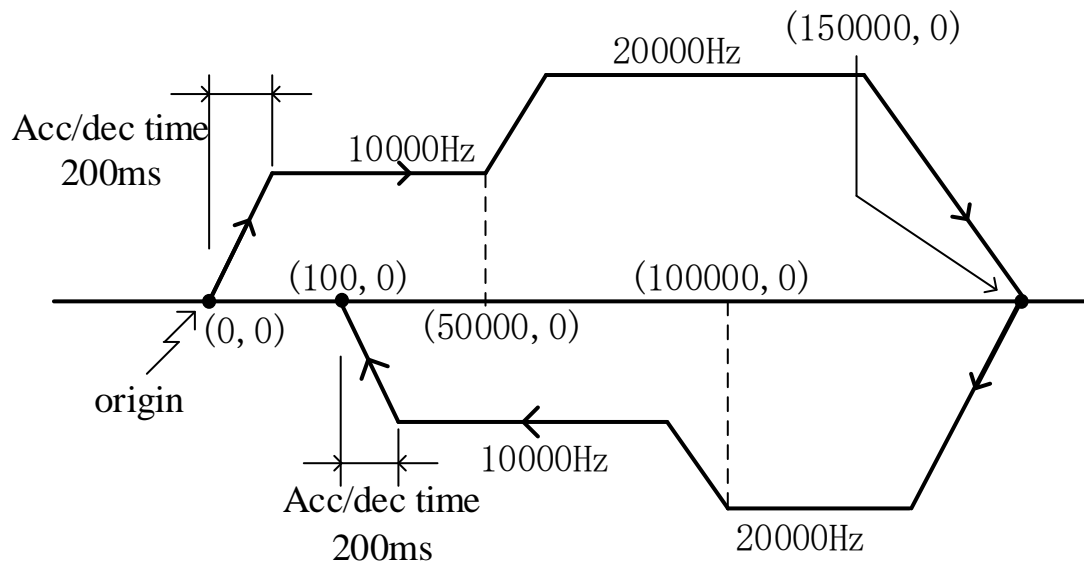

Firstly, make the ladder chart as follows:

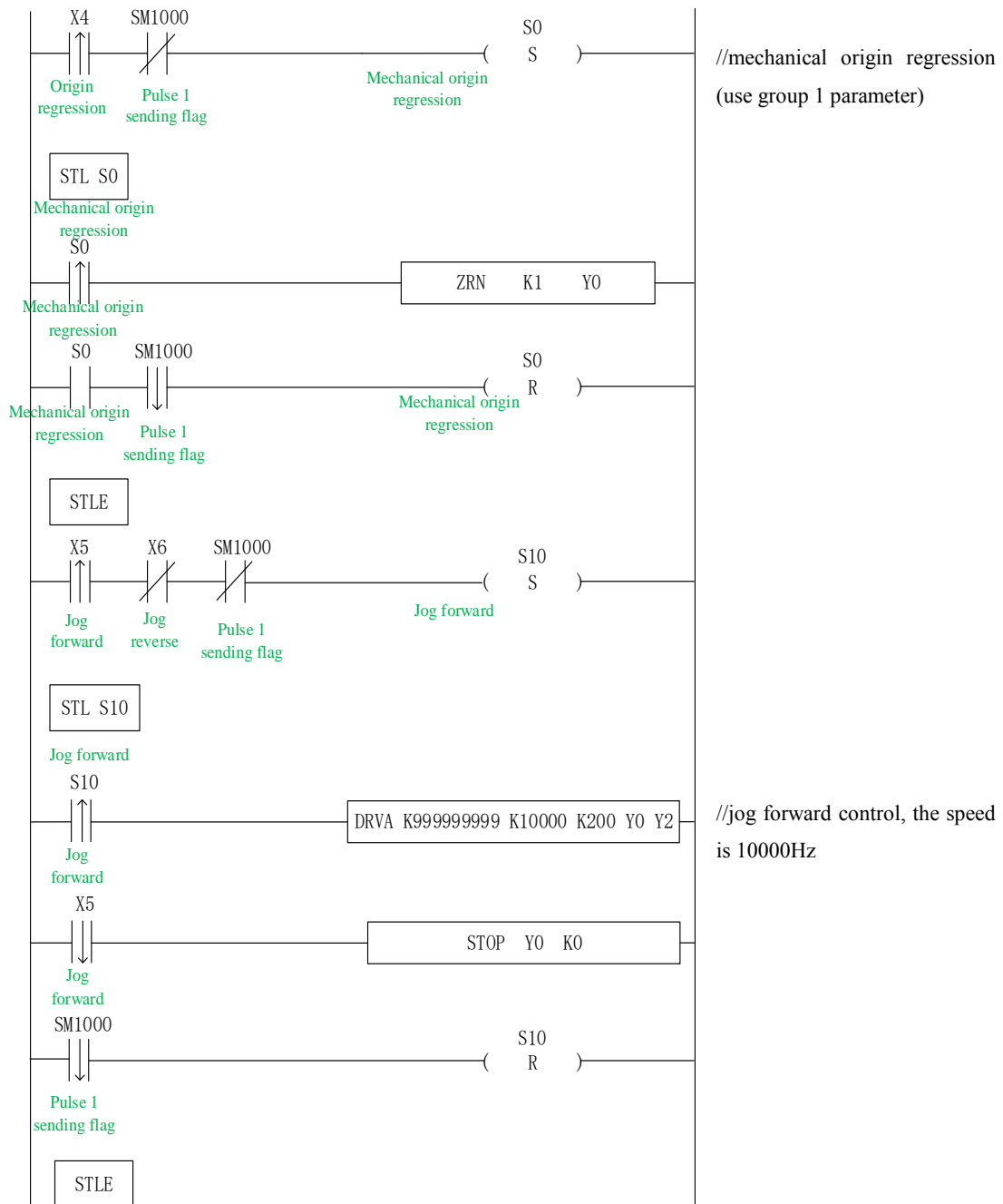



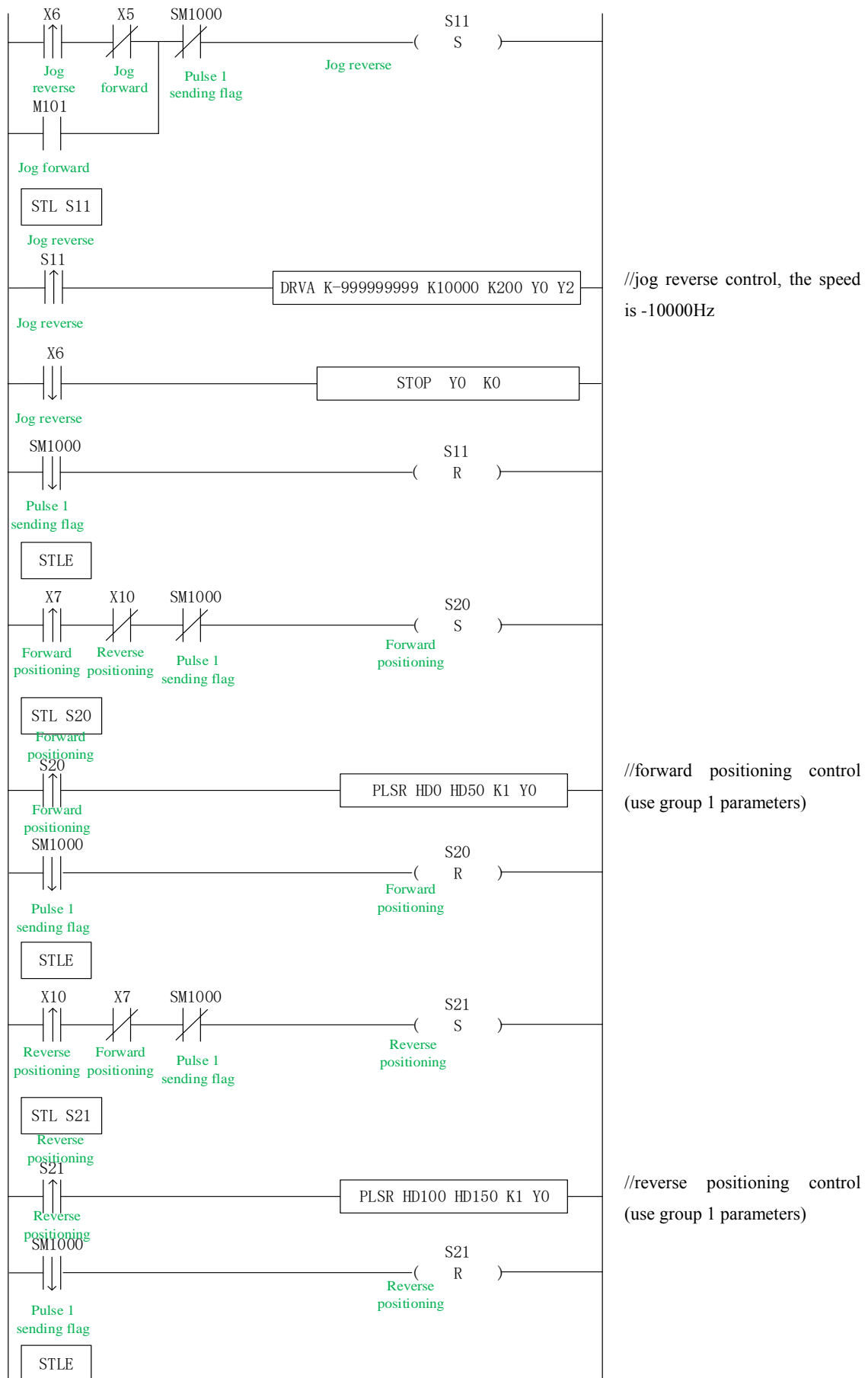

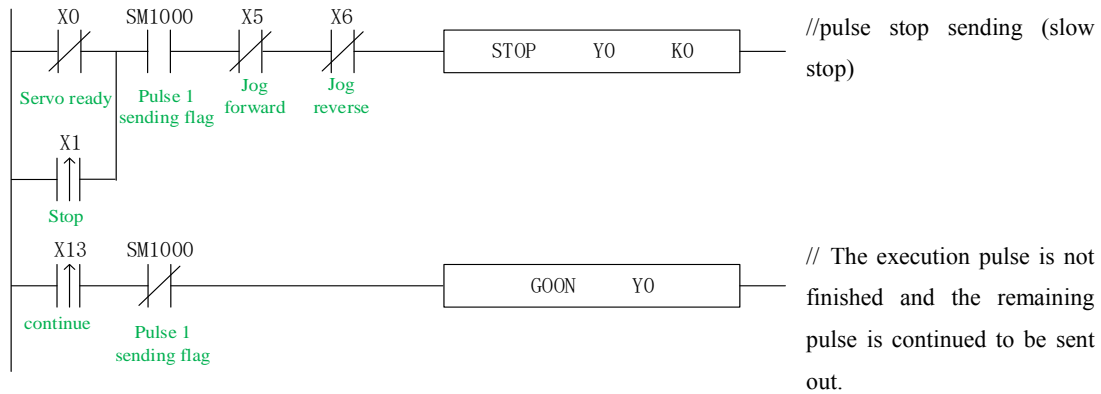

In the sample program, all the system parameters used in the pulse instructions (except DRVA, DRVI) are group 1 parameters. So, we click "pulse configuration parameters" in the PLC programming software, as follows:

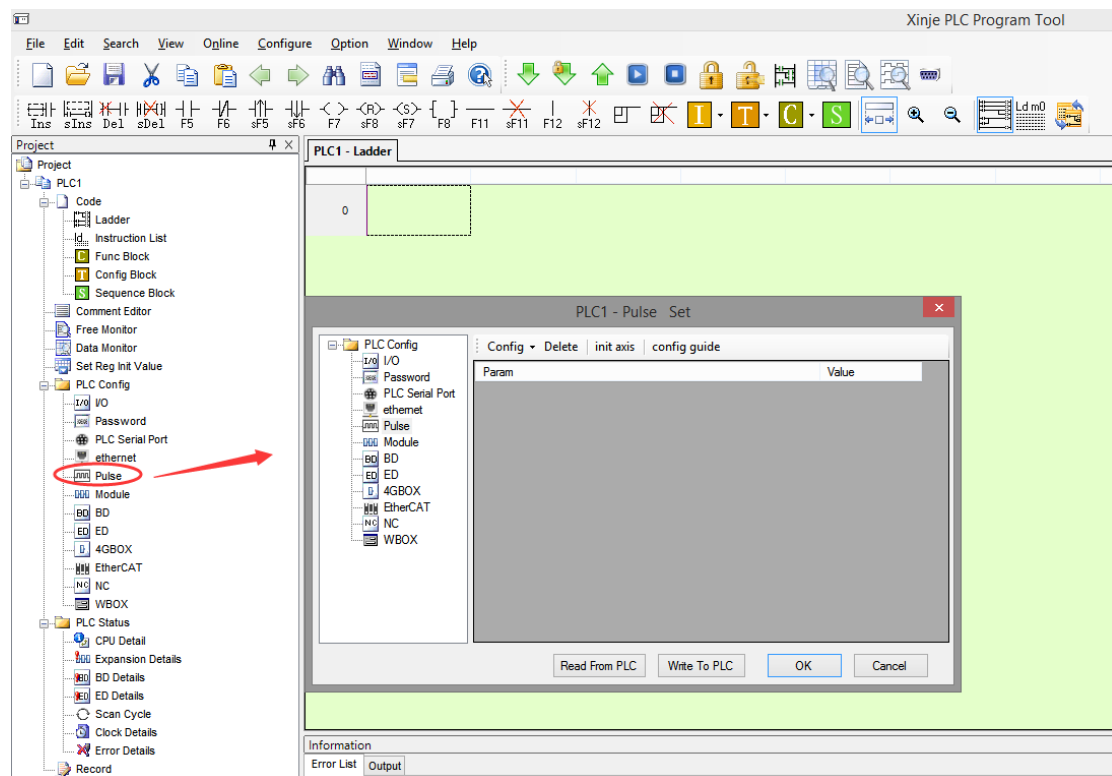

Click config, then select Y0 axis.

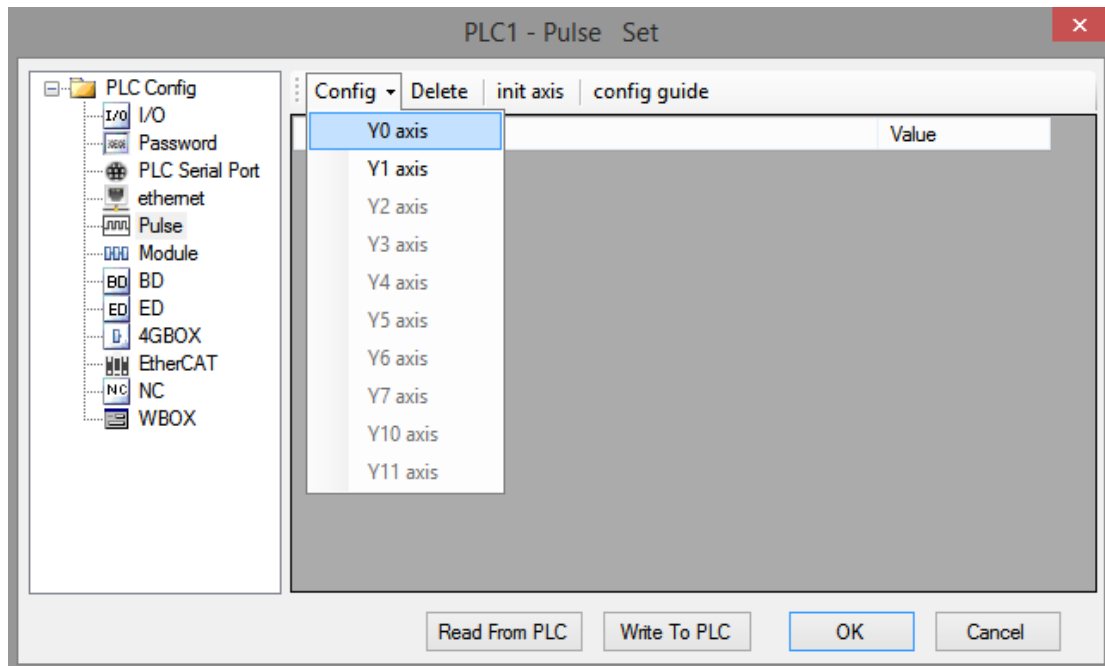

In the parameter configuration table, configure as follows (circled parameters need to be modified):

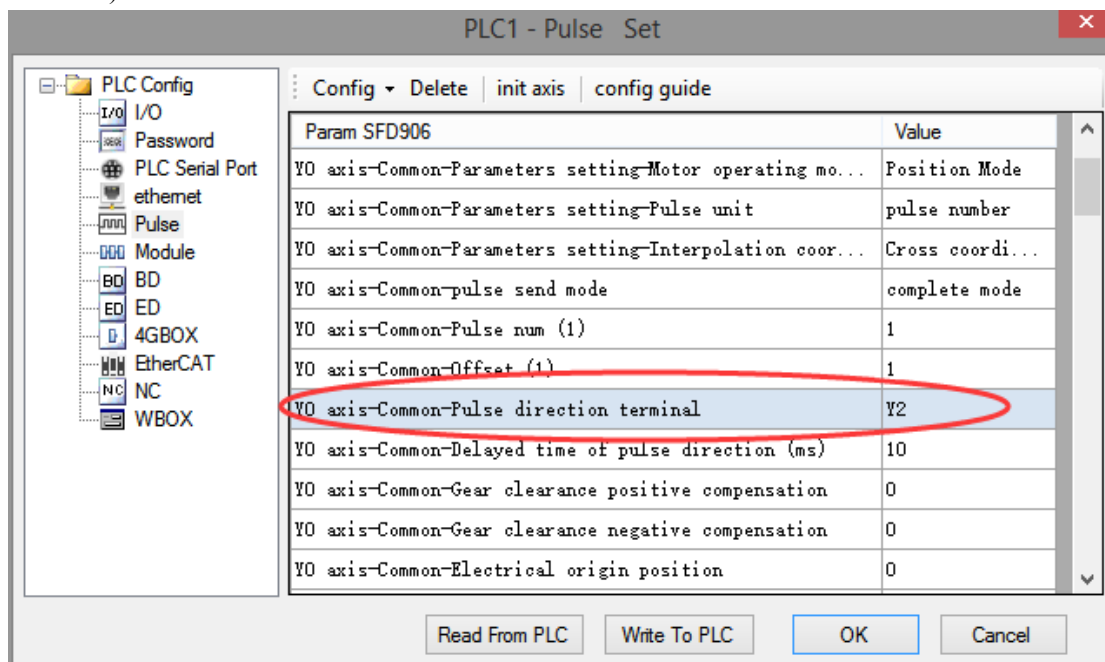

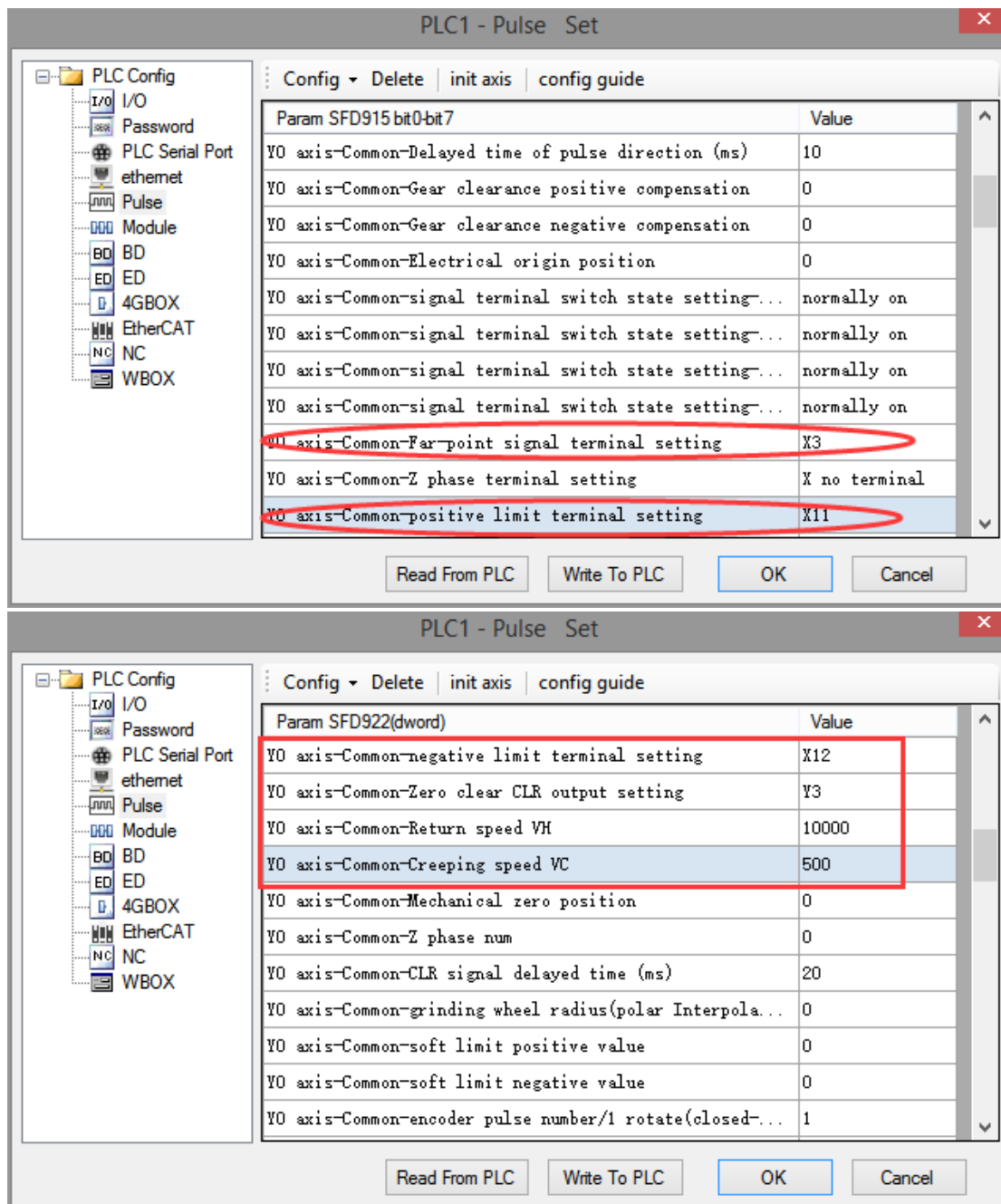

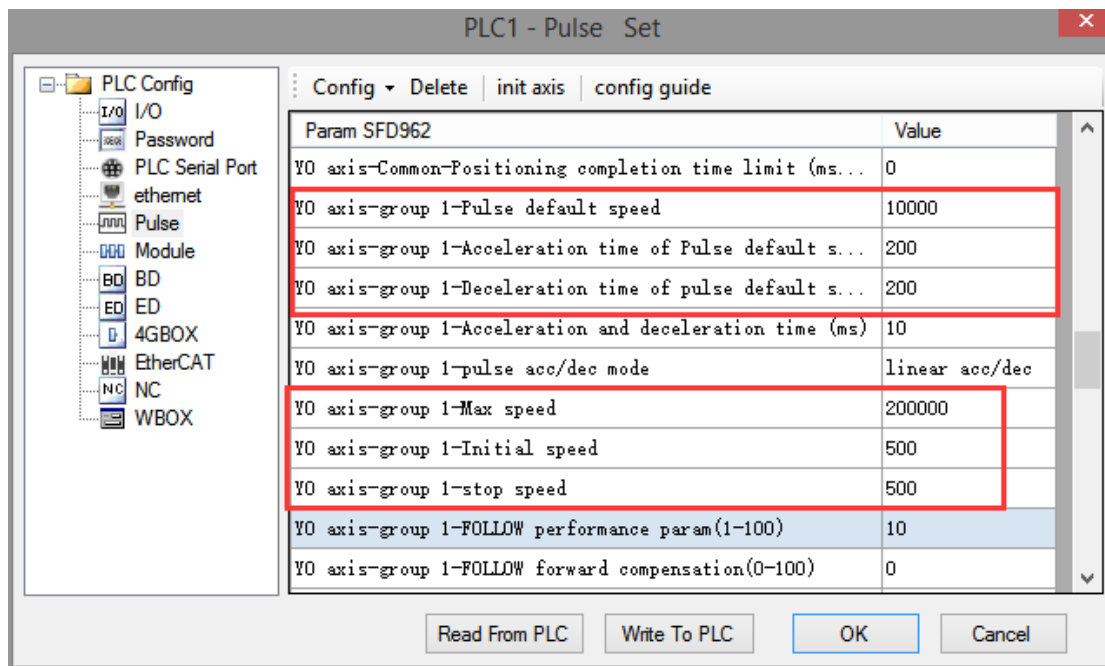

After configuring the parameters of the system parameter block, click the "Write to PLC" button to write the parameters into the PLC. Since the PLSR is used as the multi-segment pulse output instruction, we also need to configure the parameters of the pulse segment (the output frequency and the number of pulses per pulse segment).

Firstly, right-click on the forward positioning command PLSR and pop up the following options. Select the first "PLSR Instruction Parameter data Config":

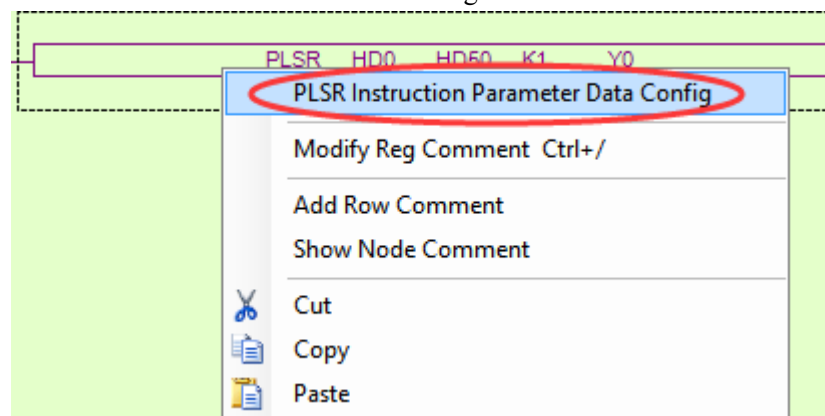

In the open multi-segment pulse output configuration table, select "mode" as "absolute" (default is "relative"), as shown in the following figure:

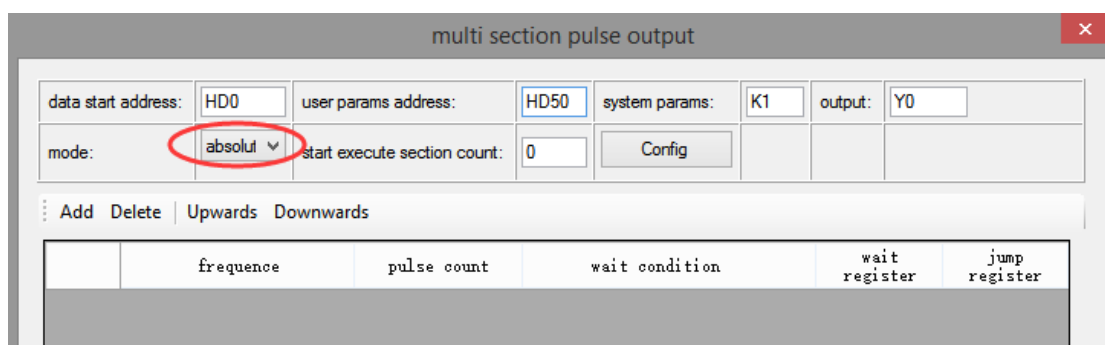

After choosing the mode, click the "Add" button in the configuration interface to add two continuous pulse parameters of forward rotation; after configuring, click the "Write to PLC" button to write parameters into the PLC, as shown in the following figure:

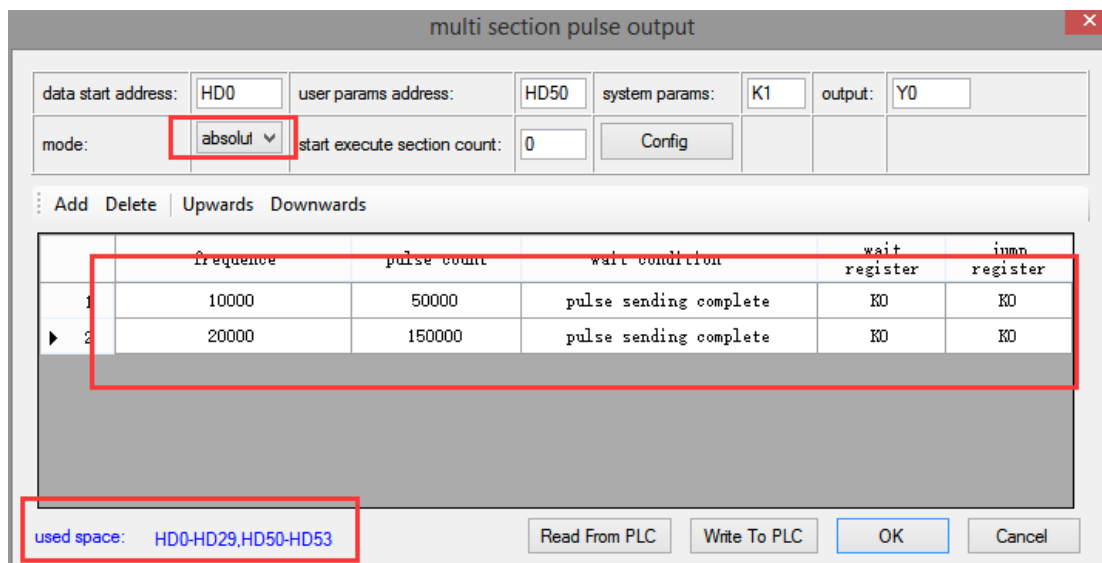

**Note:** Please note the range of real-time occupied registers displayed by "used space". Because the range of starting address of pulse parameter data of PLSR pulse instruction is HD0-HD29, and the range of system parameter block address is HD50-HD53, the range of real-time occupied registers address is not beyond the range. If the range exceeds, the error of pulse output will occur.

Then, right-click on the reverse positioning command PLSR and pop up the following options. Select the first "PLSR Instruction Parameter data Config":

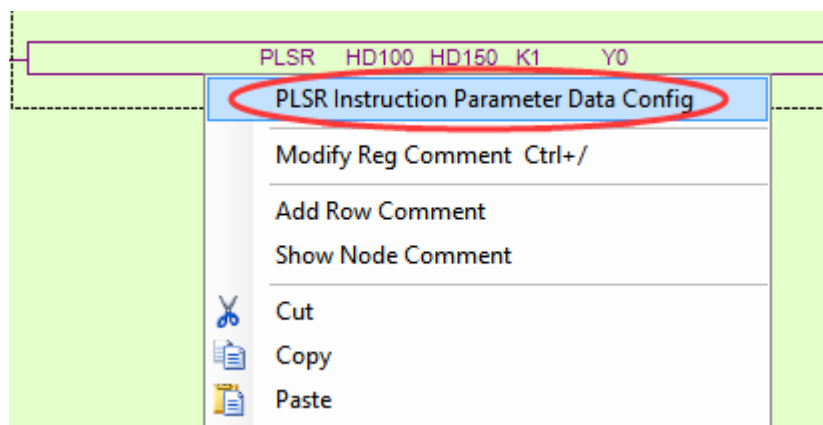

In the open multi-segment pulse output configuration table, select "mode" as "absolute" (default is "relative"), as shown in the following figure:

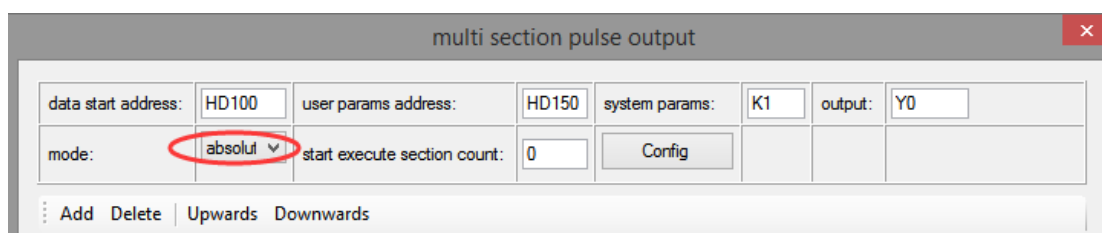

After choosing the mode, click the "Add" button in the configuration interface to add two continuous pulse parameters of forward rotation; after configuring, click the "Write to PLC" button to write parameters into the PLC, as shown in the following figure:

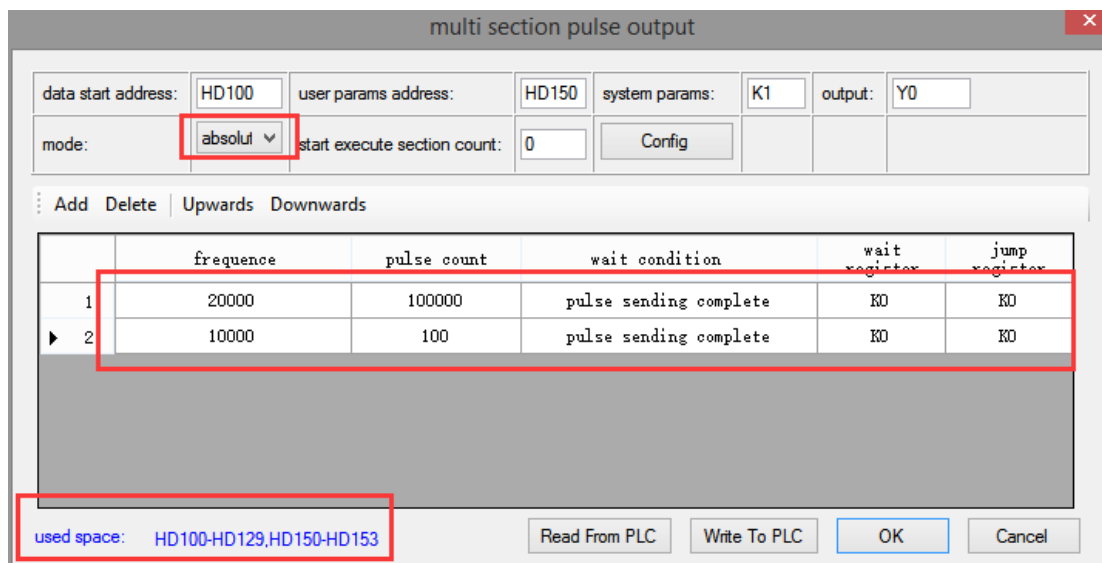

**Note:** Please note the range of real-time occupied registers displayed by "used space". Because the range of starting address of pulse parameter data of PLSR pulse instruction is HD100-HD129, and the range of system parameter block address is HD150-HD153, the range of real-time occupied registers address is not beyond the range. If the range exceeds, the error of pulse output will occur.

After downloading the program, power off the PLC and then re-energize it.

Positive Limit (X11) and Negative Limit (X12) will play an important role in the execution of ZRN, PLSF, DRVI and DRVA instructions.

**Example 2:** According to the following figure, multi-segment relative positioning method is used.

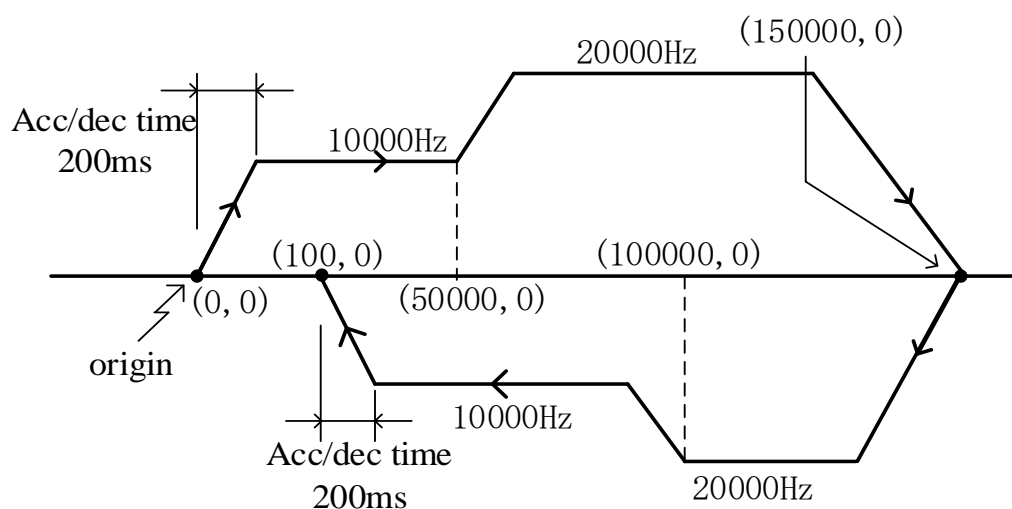

Firstly, make the ladder chart as follows:

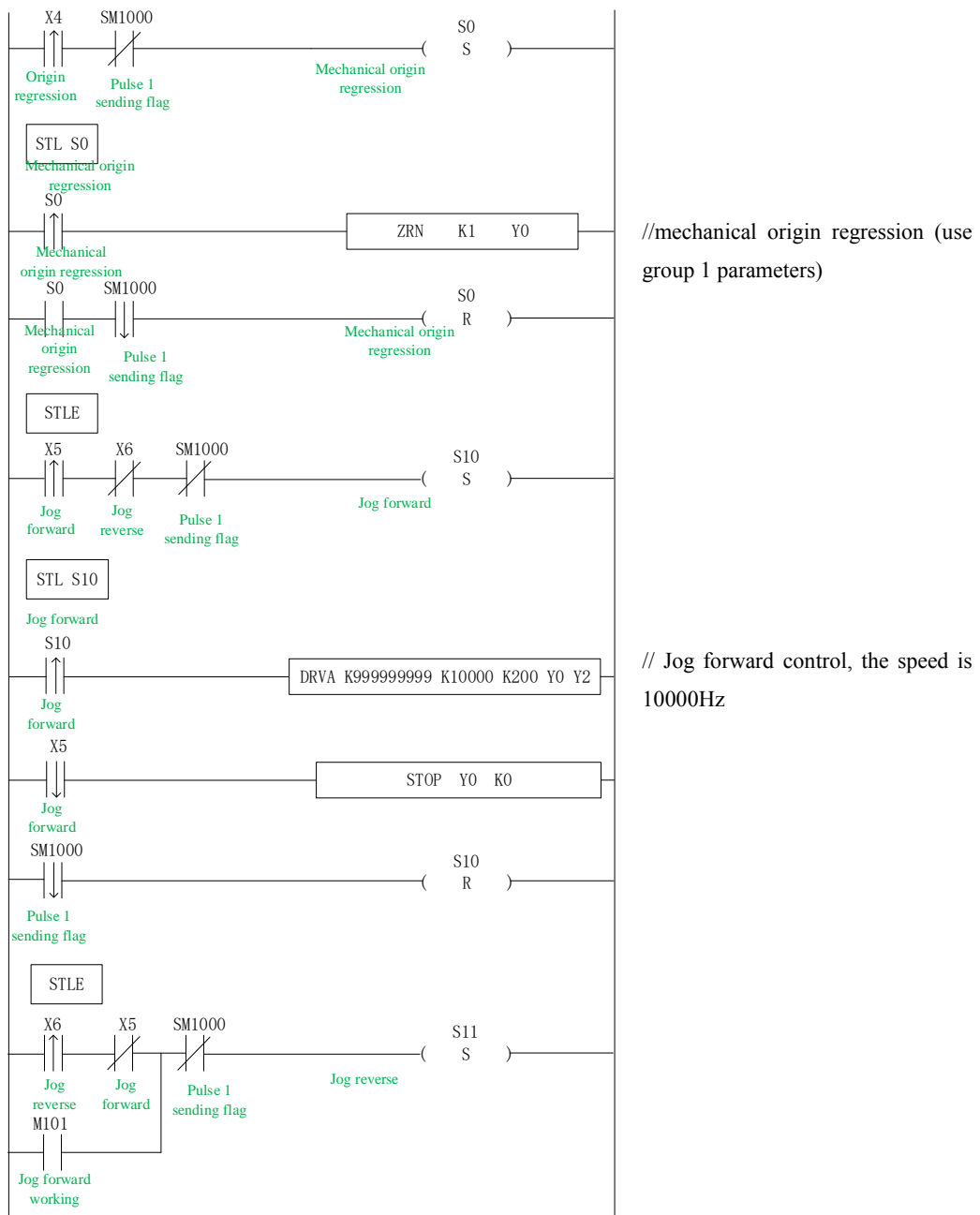



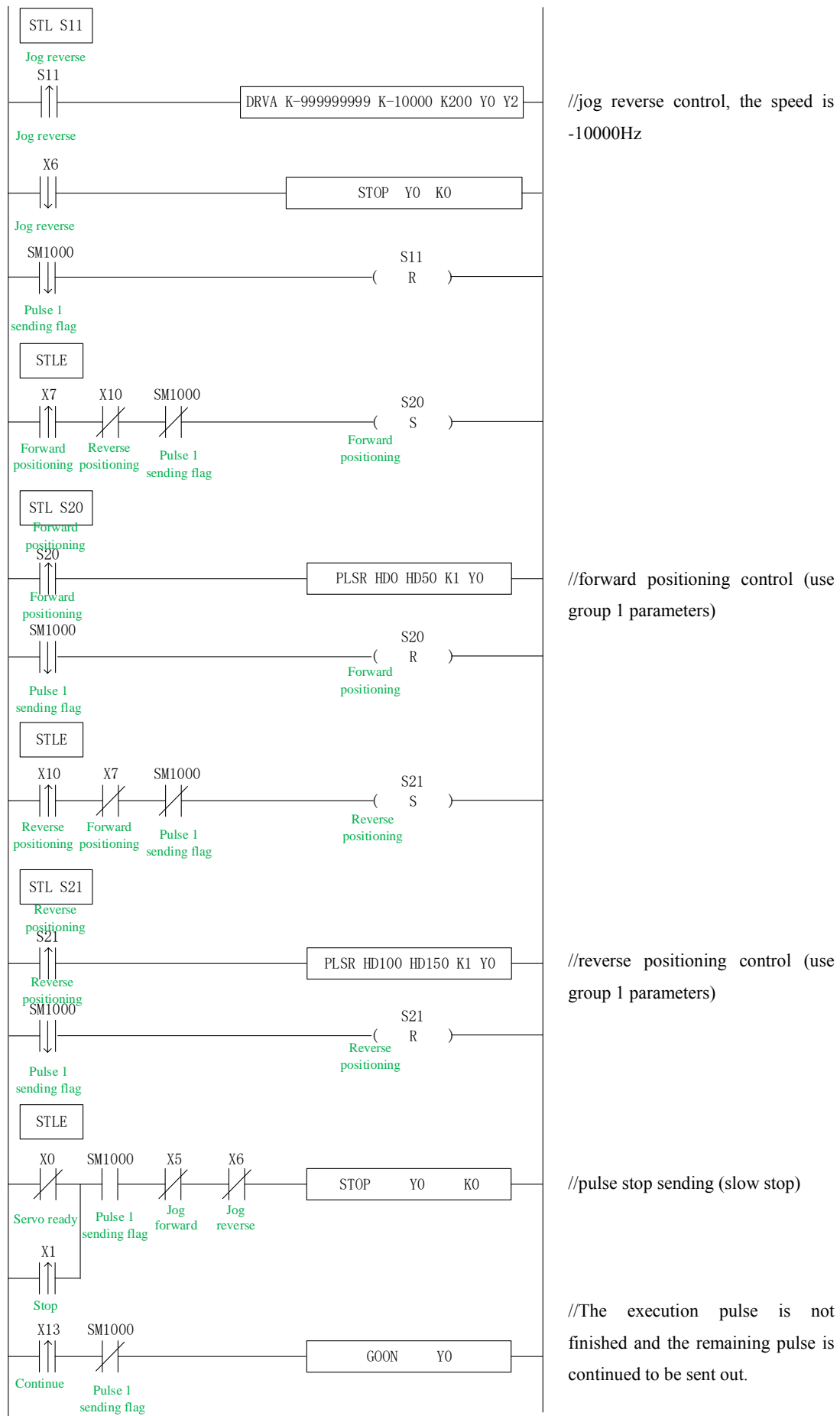

//jog reverse control, the speed is -10000Hz

//forward positioning control (use group 1 parameters)

//reverse positioning control (use group 1 parameters)

//pulse stop sending (slow stop)

//The execution pulse is not finished and the remaining pulse is continued to be sent out.

In the sample program, all the system parameters used in the pulse instructions (except DRVA, DRVI) are group 1 parameters. So, we click "pulse configuration parameters" in the PLC programming software, as follows:

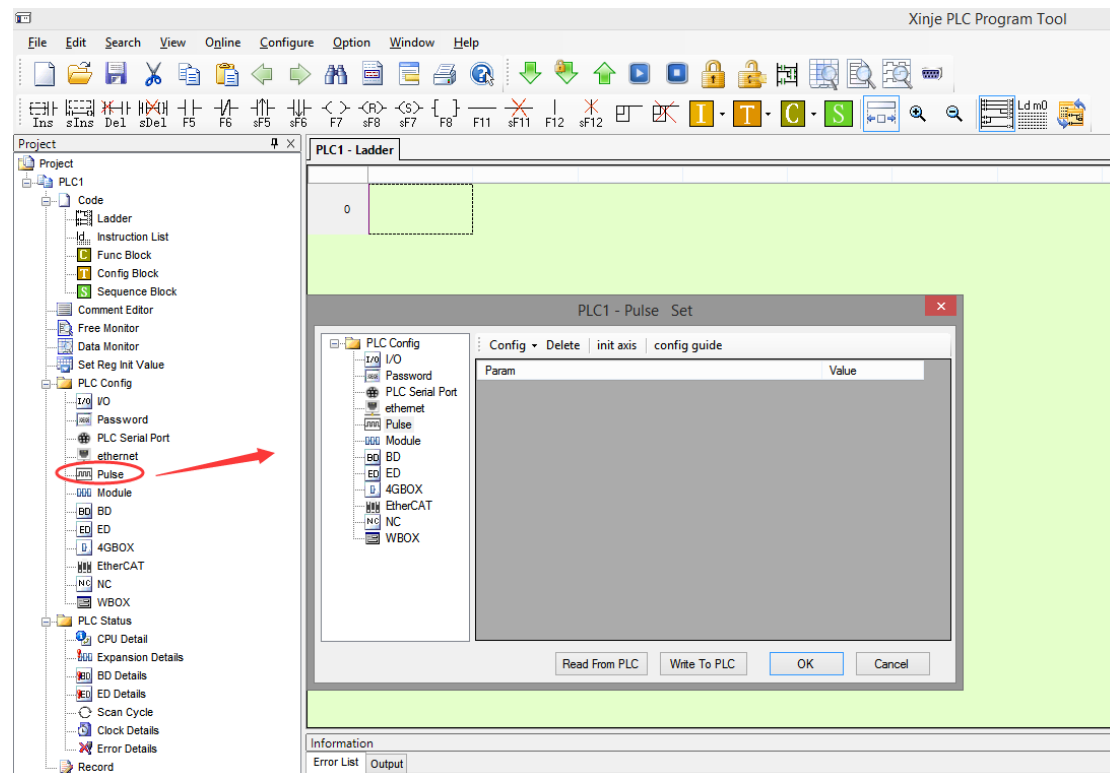

Click config, then select Y0 axis.

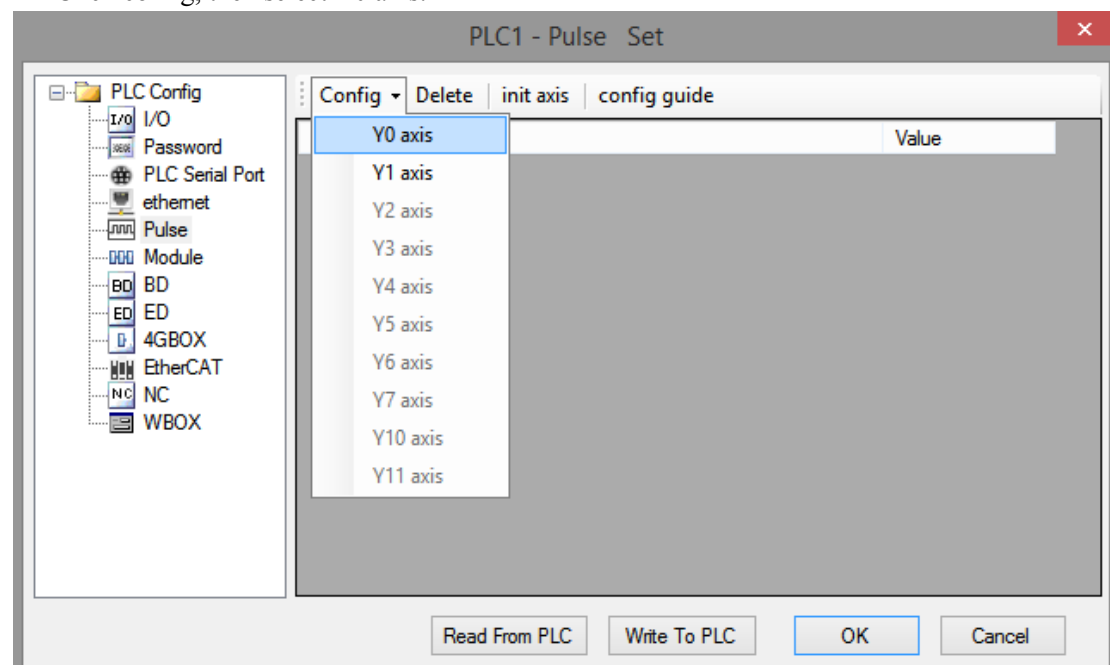

In the parameter configuration table, configure as follows (circled parameters need to be modified):

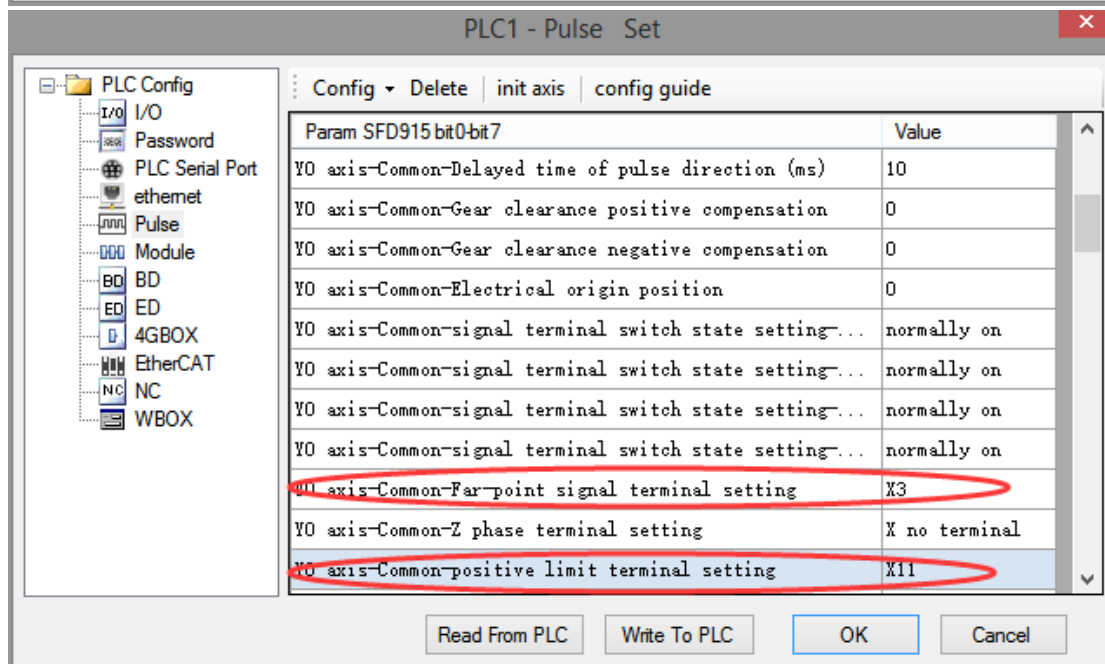
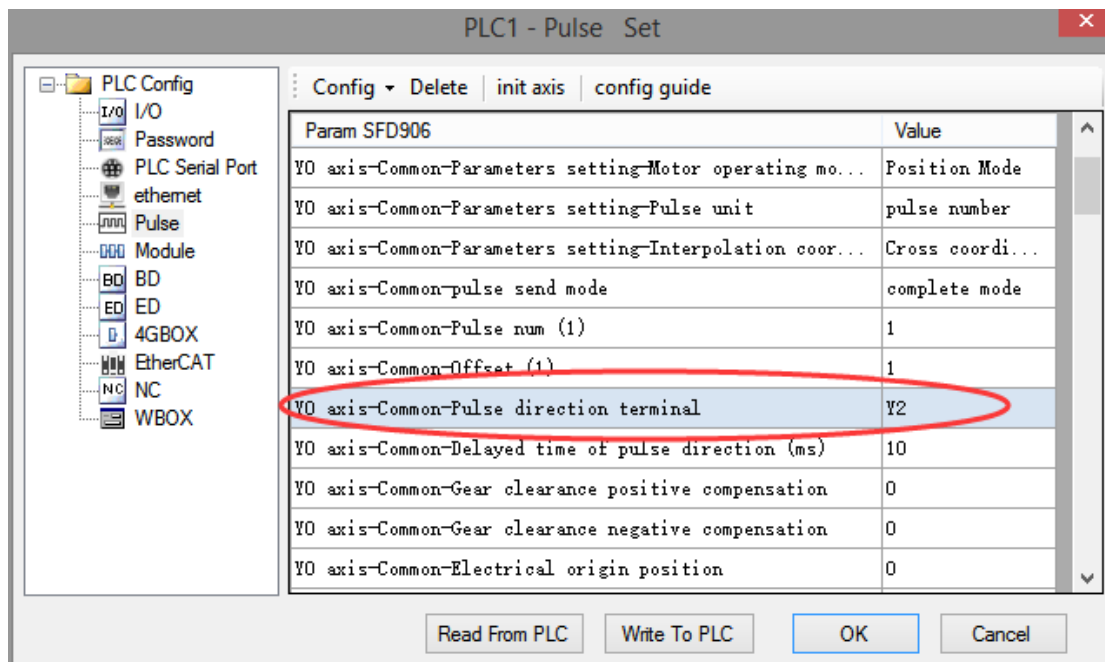

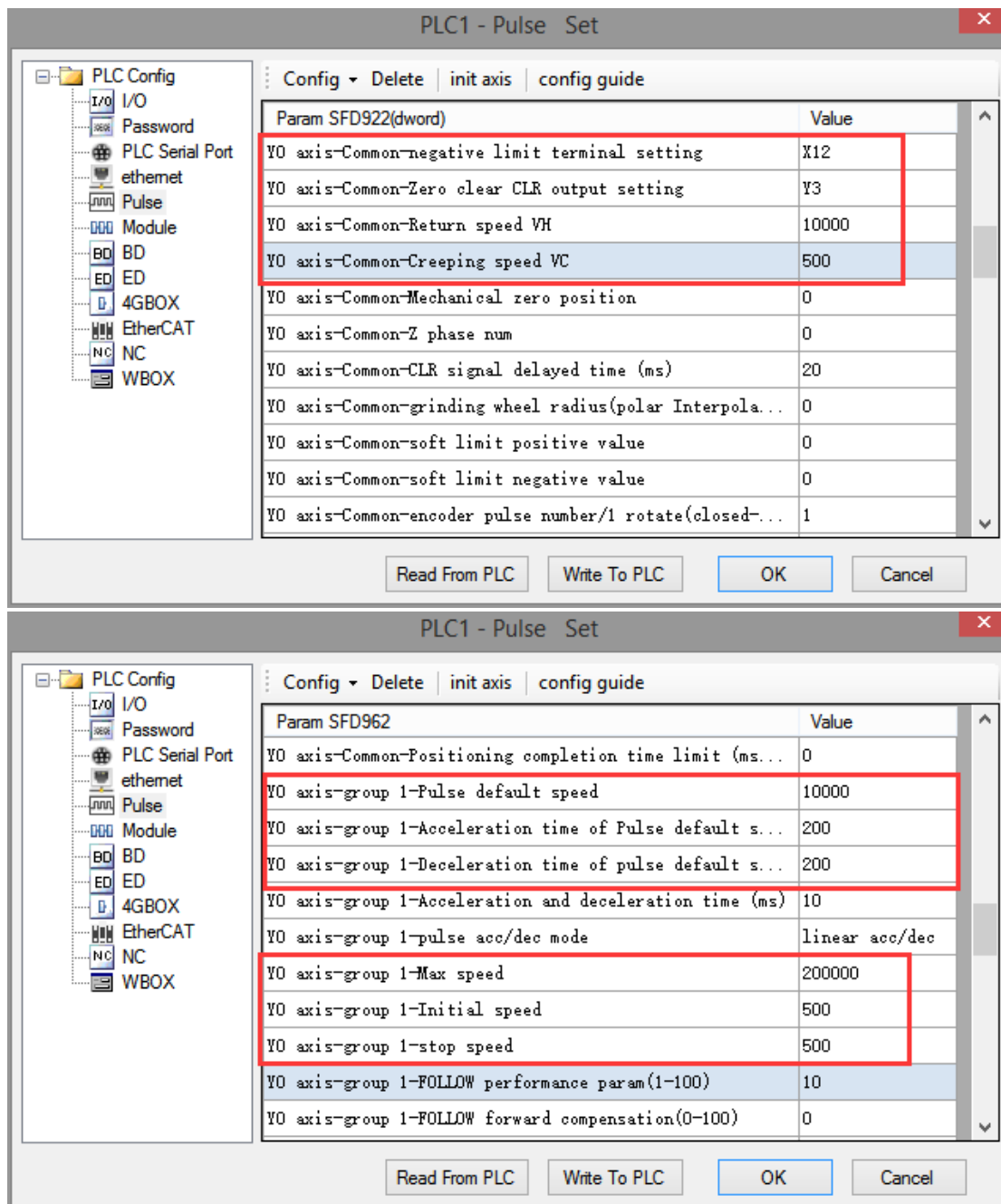

After configuring the parameters of the system parameter block, click the "Write to PLC" button to write the parameters into the PLC. Since the PLSR is used as the multi-segment pulse output instruction, we also need to configure the parameters of the pulse segment (the output frequency and the number of pulses per pulse segment).

Firstly, right-click on the forward positioning command PLSR and pop up the following options. Select the first "PLSR Instruction Parameter data Config":

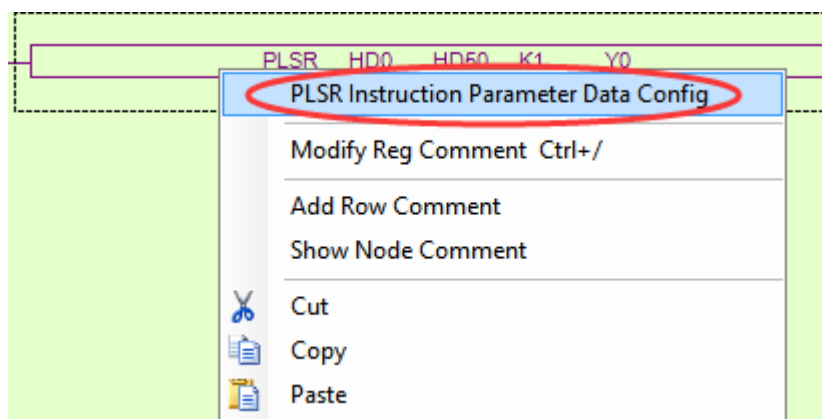

In the open multi-segment pulse output configuration table, select "mode" as "relative" (default is "relative"), as shown in the following figure:

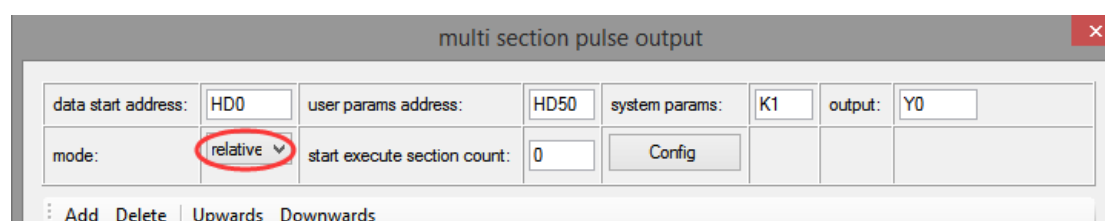

After choosing the mode, click the "Add" button in the configuration interface to add two continuous pulse parameters of forward rotation; after configuring, click the "Write to PLC" button to write parameters into the PLC, as shown in the following figure:

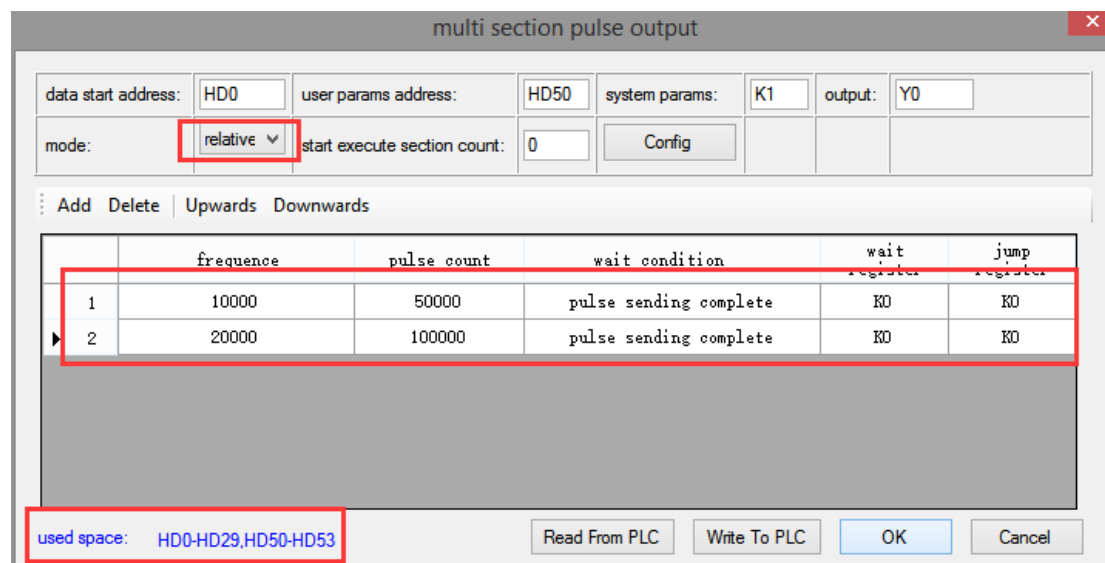

**Note: Please note the range of real-time occupied registers displayed by "used space". Because the range of starting address of pulse parameter data of PLSR pulse instruction is HD0-HD29, and the range of system parameter block address is HD50-HD53, the range of real-time occupied registers address is not beyond the range. If the range exceeds, the error of pulse output will occur.**

Then, right-click on the reverse positioning command PLSR and pop up the following options. Select the first "PLSR Instruction Parameter data Config":

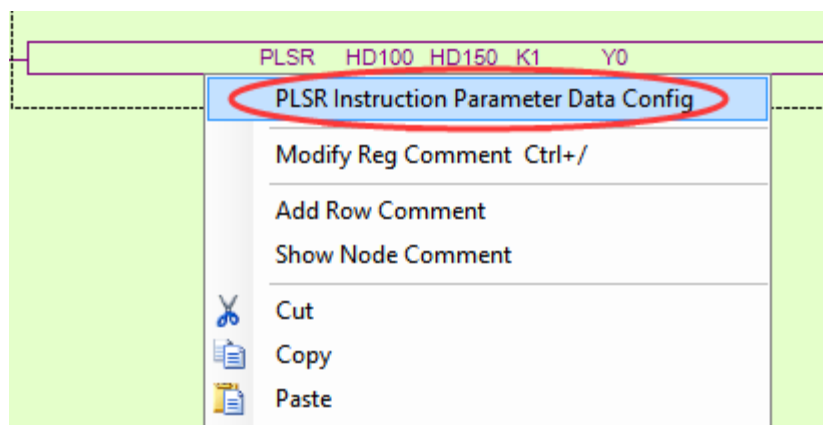

In the open multi-segment pulse output configuration table, select "mode" as "relative" (default is "relative"), as shown in the following figure:

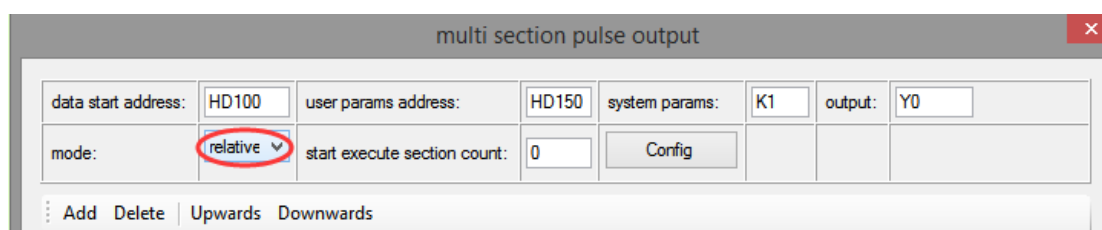

After choosing the mode, click the "Add" button in the configuration interface to add two continuous pulse parameters of reverse rotation; after configuring, click the "Write to PLC" button to write parameters into the PLC, as shown in the following figure:

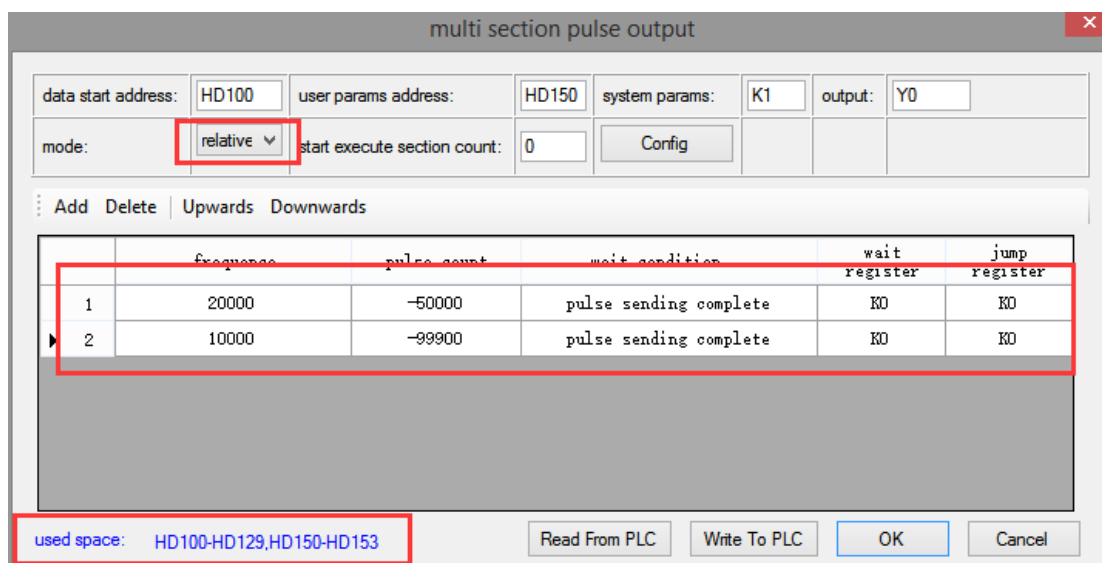

**Note:** Please note the range of real-time occupied registers displayed by "used space". Because the range of starting address of pulse parameter data of PLSR pulse instruction is HD100-HD129, and the range of system parameter block address is HD150-HD153, the range of real-time occupied registers address is not beyond the range. If the range exceeds, the error of pulse output will occur.

After downloading the program, power off the PLC and then re-energize it.

Positive Limit (X11) and Negative Limit (X12) will play an important role in the execution of

ZRN, PLSF, DRVI and DRVA instructions.

### 1-6. Pulse Output Coil and Register

#### Pulse output flag bit:

Coil	Function	Notes	
SM1000	Pulse sending flag	1 is pulse sending	PULSE_1
SM1001	Direction flag	1 is positive direction, related direction output is ON	
SM1002	Overflow flag of accumulated pulse number	1 is overflow	
SM1003	Overflow flag of accumulated pulse equivalent	1 is overflow	
SM1010	Pulse error flag	ON is error	
SM1020	Pulse sending flag	1 is pulse sending	PULSE_2
SM1021	Direction flag	1 is positive direction, related direction output is ON	
SM1022	Overflow flag of accumulated pulse number	1 is overflow	
SM1023	Overflow flag of accumulated pulse equivalent	1 is overflow	
SM1030	Pulse error flag	ON is error	
SM1040	Pulse sending flag	1 is pulse sending	PULSE_3
SM1041	Direction flag	1 is positive direction, related direction output is ON	
SM1042	Overflow flag of accumulated pulse number	1 is overflow	
SM1043	Overflow flag of accumulated pulse equivalent	1 is overflow	
SM1050	Pulse error flag	ON is error	
SM1060	Pulse sending flag	1 is pulse sending	PULSE_4
SM1061	Direction flag	1 is positive direction, related direction output is ON	
SM1062	Overflow flag of accumulated pulse number	1 is overflow	
SM1063	Overflow flag of accumulated pulse equivalent	1 is overflow	
SM1070	Pulse error flag	ON is error	

SM1080	Pulse sending flag	1 is pulse sending	PULSE_5
SM1081	Direction flag	1 is positive direction, related direction output is ON	
SM1082	Overflow flag of accumulated pulse number	1 is overflow	
SM1083	Overflow flag of accumulated pulse equivalent	1 is overflow	
SM1090	Pulse error flag	ON is error	
SM1100	Pulse sending flag	1 is pulse sending	PULSE_6
SM1101	Direction flag	1 is positive direction, related direction output is ON	
SM1102	Overflow flag of accumulated pulse number	1 is overflow	
SM1103	Overflow flag of accumulated pulse equivalent	1 is overflow	
SM1110	Pulse error flag	ON is error	
SM1120	Pulse sending flag	1 is pulse sending	PULSE_7
SM1121	Direction flag	1 is positive direction, related direction output is ON	
SM1122	Overflow flag of accumulated pulse number	1 is overflow	
SM1123	Overflow flag of accumulated pulse equivalent	1 is overflow	
SM1130	Pulse error flag	ON is error	
SM1140	Pulse sending flag	1 is pulse sending	PULSE_8
SM1141	Direction flag	1 is positive direction, related direction output is ON	
SM1142	Overflow flag of accumulated pulse number	1 is overflow	
SM1143	Overflow flag of accumulated pulse equivalent	1 is overflow	
SM1150	Pulse error flag	ON is error	
SM1160	Pulse sending flag	1 is pulse sending	PULSE_9
SM1161	Direction flag	1 is positive direction, related direction output is ON	
SM1162	Overflow flag of accumulated pulse number	1 is overflow	
SM1163	Overflow flag of accumulated pulse	1 is overflow	



	equivalent		PULSE_10
SM1170	Pulse error flag	ON is error	
SM1180	Pulse sending flag	1 is pulse sending	
SM1181	Direction flag	1 is positive direction, related direction output is ON	
SM1182	Overflow flag of accumulated pulse number	1 is overflow	
SM1183	Overflow flag of accumulated pulse equivalent	1 is overflow	
SM1190	Pulse error flag	ON is error	

**Pulse output related special registers:**

Register	Function	Notes	
SD1000	Present segment (represents segment n)		PULSE_1
SD1001			
SD1002	Present pulse number low 16-bit (the unit is pulse number)		
SD1003	Present pulse number high 16-bit (the unit is pulse number)		
SD1004	Present pulse number low 16-bit (the unit is pulse equivalent)		
SD1005	Present pulse number high 16-bit (the unit is pulse equivalent)		
SD1006	Present pulse number low 16-bit (the unit is pulse number)		
SD1007	Present pulse number high 16-bit (the unit is pulse number)		
SD1008	Present pulse number low 16-bit (the unit is pulse equivalent)		
SD1009	Present pulse number high 16-bit (the unit is pulse equivalent)		
SD1010	Pulse error information	1: pulse data segment configuration error 2: In equivalent mode, the number of pulses per rotation and the movement per rotation is 0 3: System parameter block number error	

		<p>4: Pulse parameter block number exceeding maximum limit</p> <p>5: Stop after encountering positive limit signal</p> <p>6: Stop after meeting the negative limit signal</p> <p>10: No origin signal is set for origin regression</p> <p>11: Velocity of origin regression VH is 0</p> <p>12: Origin regression crawling speed VC is 0 or <math>VC \geq VH</math></p> <p>13: Origin regression signal error</p> <p>15: Follow Performance Parameters <math>\leq 0</math> or <math>&gt;100</math></p> <p>16: Follow Feedforward Compensation <math>&lt;0</math> or <math>&gt;100</math></p> <p>17: Follow Multiplication Coefficient and Division Coefficient Ratio <math>\leq 0</math> or <math>&gt;100</math></p> <p>20: Interpolation Direction Terminal Not Set or Set Error</p> <p>21: The default maximum interpolation speed is 0</p> <p>22: Arc interpolation data error</p> <p>23: Arc radius data error</p> <p>24: Three-point Arc Data Error</p> <p>25: In polar coordinate mode, the current position is (0, 0)</p> <p>26: Control block allocation failed</p>	
SD1011	Error pulse data block number		
SD1020	Present segment (represents segment n)		PULSE_2
SD1021			
SD1022	Present pulse number low 16-bit (the unit is pulse number)		
SD1023	Present pulse number high 16-bit (the unit is pulse number)		
SD1024	Present pulse number low 16-bit (the unit is pulse equivalent)		
SD1025	Present pulse number high 16-bit (the unit is pulse equivalent)		
SD1026	Present pulse number low 16-bit (the unit is pulse number)		

SD1027	Present pulse number high 16-bit (the unit is pulse number)		
SD1028	Present pulse number low 16-bit (the unit is pulse equivalent)		
SD1029	Present pulse number high 16-bit (the unit is pulse equivalent)		
SD1030	Pulse error information	<p>1: pulse data segment configuration error</p> <p>2: In equivalent mode, the number of pulses per rotation and the movement per rotation is 0</p> <p>3: System parameter block number error</p> <p>4: Pulse parameter block number exceeding maximum limit</p> <p>5: Stop after encountering positive limit signal</p> <p>6: Stop after meeting the negative limit signal</p> <p>10: No origin signal is set for origin regression</p> <p>11: Velocity of origin regression VH is 0</p> <p>12: Origin regression crawling speed VC is 0 or <math>VC \geq VH</math></p> <p>13: Origin regression signal error</p> <p>15: Follow Performance Parameters <math>\leq 0</math> or <math>&gt;100</math></p> <p>16: Follow Feedforward Compensation <math>&lt;0</math> or <math>&gt;100</math></p> <p>17: Follow Multiplication Coefficient and Division Coefficient Ratio <math>\leq 0</math> or <math>&gt;100</math></p> <p>20: Interpolation Direction Terminal Not Set or Set Error</p> <p>21: The default maximum interpolation speed is 0</p> <p>22: Arc interpolation data error</p> <p>23: Arc radius data error</p> <p>24: Three-point Arc Data Error</p> <p>25: In polar coordinate mode, the current position is (0, 0)</p> <p>26: Control block allocation failed</p>	
SD1031	Error pulse data block number		
SD1040	Present segment (represents segment n)		PULSE_3
SD1041			
SD1042	Present pulse number		

	low 16-bit (the unit is pulse number)		
SD1043	Present pulse number high 16-bit (the unit is pulse number)		
SD1044	Present pulse number low 16-bit (the unit is pulse equivalent)		
SD1045	Present pulse number high 16-bit (the unit is pulse equivalent)		
SD1046	Present pulse number low 16-bit (the unit is pulse number)		
SD1047	Present pulse number high 16-bit (the unit is pulse number)		
SD1048	Present pulse number low 16-bit (the unit is pulse equivalent)		
SD1049	Present pulse number high 16-bit (the unit is pulse equivalent)		
SD1050	Pulse error information	<p>1: pulse data segment configuration error</p> <p>2: In equivalent mode, the number of pulses per rotation and the movement per rotation is 0</p> <p>3: System parameter block number error</p> <p>4: Pulse parameter block number exceeding maximum limit</p> <p>5: Stop after encountering positive limit signal</p> <p>6: Stop after meeting the negative limit signal</p> <p>10: No origin signal is set for origin regression</p> <p>11: Velocity of origin regression VH is 0</p> <p>12: Origin regression crawling speed VC is 0 or <math>VC \geq VH</math></p> <p>13: Origin regression signal error</p> <p>15: Follow Performance Parameters <math>\leq 0</math> or <math>&gt;100</math></p> <p>16: Follow Feedforward Compensation <math>&lt;0</math> or <math>&gt;100</math></p> <p>17: Follow Multiplication Coefficient and Division Coefficient Ratio <math>\leq 0</math> or <math>&gt;100</math></p> <p>20: Interpolation Direction Terminal Not Set or Set Error</p> <p>21: The default maximum interpolation speed</p>	

		<p>is 0</p> <p>22: Arc interpolation data error</p> <p>23: Arc radius data error</p> <p>24: Three-point Arc Data Error</p> <p>25: In polar coordinate mode, the current position is (0, 0)</p> <p>26: Control block allocation failed</p>	
SD1051	Error pulse data block number		
SD1060	Present segment (represents segment n)		PULSE_4
SD1061			
SD1062	Present pulse number low 16-bit (the unit is pulse number)		
SD1063	Present pulse number high 16-bit (the unit is pulse number)		
SD1064	Present pulse number low 16-bit (the unit is pulse equivalent)		
SD1065	Present pulse number high 16-bit (the unit is pulse equivalent)		
SD1066	Present pulse number low 16-bit (the unit is pulse number)		
SD1067	Present pulse number high 16-bit (the unit is pulse number)		
SD1068	Present pulse number low 16-bit (the unit is pulse equivalent)		
SD1069	Present pulse number high 16-bit (the unit is pulse equivalent)		
SD1070	Pulse error information	<p>1: pulse data segment configuration error</p> <p>2: In equivalent mode, the number of pulses per rotation and the movement per rotation is 0</p> <p>3: System parameter block number error</p> <p>4: Pulse parameter block number exceeding maximum limit</p> <p>5: Stop after encountering positive limit signal</p> <p>6: Stop after meeting the negative limit signal</p>	

		<p>10: No origin signal is set for origin regression</p> <p>11: Velocity of origin regression VH is 0</p> <p>12: Origin regression crawling speed VC is 0 or <math>VC \geq VH</math></p> <p>13: Origin regression signal error</p> <p>15: Follow Performance Parameters <math>\leq 0</math> or <math>&gt;100</math></p> <p>16: Follow Feedforward Compensation <math>&lt;0</math> or <math>&gt;100</math></p> <p>17: Follow Multiplication Coefficient and Division Coefficient Ratio <math>\leq 0</math> or <math>&gt;100</math></p> <p>20: Interpolation Direction Terminal Not Set or Set Error</p> <p>21: The default maximum interpolation speed is 0</p> <p>22: Arc interpolation data error</p> <p>23: Arc radius data error</p> <p>24: Three-point Arc Data Error</p> <p>25: In polar coordinate mode, the current position is (0, 0)</p> <p>26: Control block allocation failed</p>	
SD1071	Error pulse data block number		
SD1080	Present segment (represents segment n)		
SD1081			
SD1082	Present pulse number low 16-bit (the unit is pulse number)		
SD1083	Present pulse number high 16-bit (the unit is pulse number)		
SD1084	Present pulse number low 16-bit (the unit is pulse equivalent)		
SD1085	Present pulse number high 16-bit (the unit is pulse equivalent)		
SD1086	Present pulse number low 16-bit (the unit is pulse number)		
SD1087	Present pulse number high 16-bit (the unit is pulse number)		
SD1088	Present pulse number		PULSE_5

	low 16-bit (the unit is pulse equivalent)		
SD1089	Present pulse number high 16-bit (the unit is pulse equivalent)		
SD1090	Pulse error information	<p>1: pulse data segment configuration error</p> <p>2: In equivalent mode, the number of pulses per rotation and the movement per rotation is 0</p> <p>3: System parameter block number error</p> <p>4: Pulse parameter block number exceeding maximum limit</p> <p>5: Stop after encountering positive limit signal</p> <p>6: Stop after meeting the negative limit signal</p> <p>10: No origin signal is set for origin regression</p> <p>11: Velocity of origin regression VH is 0</p> <p>12: Origin regression crawling speed VC is 0 or <math>VC \geq VH</math></p> <p>13: Origin regression signal error</p> <p>15: Follow Performance Parameters <math>\leq 0</math> or <math>&gt;100</math></p> <p>16: Follow Feedforward Compensation <math>&lt;0</math> or <math>&gt;100</math></p> <p>17: Follow Multiplication Coefficient and Division Coefficient Ratio <math>\leq 0</math> or <math>&gt;100</math></p> <p>20: Interpolation Direction Terminal Not Set or Set Error</p> <p>21: The default maximum interpolation speed is 0</p> <p>22: Arc interpolation data error</p> <p>23: Arc radius data error</p> <p>24: Three-point Arc Data Error</p> <p>25: In polar coordinate mode, the current position is (0, 0)</p> <p>26: Control block allocation failed</p>	
SD1091	Error pulse data block number		
SD1100	Present segment (represents segment n)		
SD1101			
SD1102	Present pulse number low 16-bit (the unit is pulse number)		PULSE_6
SD1103	Present pulse number high 16-bit (the unit is		

	pulse number)		
SD1104	Present pulse number low 16-bit (the unit is pulse equivalent)		
SD1105	Present pulse number high 16-bit (the unit is pulse equivalent)		
SD1106	Present pulse number low 16-bit (the unit is pulse number)		
SD1107	Present pulse number high 16-bit (the unit is pulse number)		
SD1108	Present pulse number low 16-bit (the unit is pulse equivalent)		
SD1109	Present pulse number high 16-bit (the unit is pulse equivalent)		
SD1110	Pulse error information	<p>1: pulse data segment configuration error</p> <p>2: In equivalent mode, the number of pulses per rotation and the movement per rotation is 0</p> <p>3: System parameter block number error</p> <p>4: Pulse parameter block number exceeding maximum limit</p> <p>5: Stop after encountering positive limit signal</p> <p>6: Stop after meeting the negative limit signal</p> <p>10: No origin signal is set for origin regression</p> <p>11: Velocity of origin regression VH is 0</p> <p>12: Origin regression crawling speed VC is 0 or <math>VC \geq VH</math></p> <p>13: Origin regression signal error</p> <p>15: Follow Performance Parameters <math>\leq 0</math> or <math>&gt;100</math></p> <p>16: Follow Feedforward Compensation <math>&lt;0</math> or <math>&gt;100</math></p> <p>17: Follow Multiplication Coefficient and Division Coefficient Ratio <math>\leq 0</math> or <math>&gt;100</math></p> <p>20: Interpolation Direction Terminal Not Set or Set Error</p> <p>21: The default maximum interpolation speed is 0</p> <p>22: Arc interpolation data error</p> <p>23: Arc radius data error</p>	



		24:Three-point Arc Data Error 25: In polar coordinate mode, the current position is (0, 0) 26: Control block allocation failed	
SD1111	Error pulse data block number		
SD1120	Present segment (represents segment n)		PULSE_7
SD1121			
SD1122	Present pulse number low 16-bit (the unit is pulse number)		
SD1123	Present pulse number high 16-bit (the unit is pulse number)		
SD1124	Present pulse number low 16-bit (the unit is pulse equivalent)		
SD1125	Present pulse number high 16-bit (the unit is pulse equivalent)		
SD1126	Present pulse number low 16-bit (the unit is pulse number)		
SD1127	Present pulse number high 16-bit (the unit is pulse number)		
SD1128	Present pulse number low 16-bit (the unit is pulse equivalent)		
SD1129	Present pulse number high 16-bit (the unit is pulse equivalent)		
SD1130	Pulse error information	1: pulse data segment configuration error 2: In equivalent mode, the number of pulses per rotation and the movement per rotation is 0 3: System parameter block number error 4: Pulse parameter block number exceeding maximum limit 5: Stop after encountering positive limit signal 6: Stop after meeting the negative limit signal 10: No origin signal is set for origin regression 11: Velocity of origin regression VH is 0 12: Origin regression crawling speed VC is 0 or $VC \geq VH$	

		<p>13: Origin regression signal error</p> <p>15: Follow Performance Parameters <math>\leq 0</math> or <math>&gt;100</math></p> <p>16: Follow Feedforward Compensation <math>&lt;0</math> or <math>&gt;100</math></p> <p>17: Follow Multiplication Coefficient and Division Coefficient Ratio <math>\leq 0</math> or <math>&gt;100</math></p> <p>20: Interpolation Direction Terminal Not Set or Set Error</p> <p>21: The default maximum interpolation speed is 0</p> <p>22: Arc interpolation data error</p> <p>23: Arc radius data error</p> <p>24: Three-point Arc Data Error</p> <p>25: In polar coordinate mode, the current position is (0, 0)</p> <p>26: Control block allocation failed</p>	
SD1131	Error pulse data block number		
SD1140	Present segment (represents segment n)		
SD1141			
SD1142	Present pulse number low 16-bit (the unit is pulse number)		
SD1143	Present pulse number high 16-bit (the unit is pulse number)		
SD1144	Present pulse number low 16-bit (the unit is pulse equivalent)		
SD1145	Present pulse number high 16-bit (the unit is pulse equivalent)		
SD1146	Present pulse number low 16-bit (the unit is pulse number)		
SD1147	Present pulse number high 16-bit (the unit is pulse number)		
SD1148	Present pulse number low 16-bit (the unit is pulse equivalent)		
SD1149	Present pulse number high 16-bit (the unit is pulse equivalent)		PULSE 8

SD1150	Pulse error information	<p>1: pulse data segment configuration error</p> <p>2: In equivalent mode, the number of pulses per rotation and the movement per rotation is 0</p> <p>3: System parameter block number error</p> <p>4: Pulse parameter block number exceeding maximum limit</p> <p>5: Stop after encountering positive limit signal</p> <p>6: Stop after meeting the negative limit signal</p> <p>10: No origin signal is set for origin regression</p> <p>11: Velocity of origin regression VH is 0</p> <p>12: Origin regression crawling speed VC is 0 or <math>VC \geq VH</math></p> <p>13: Origin regression signal error</p> <p>15: Follow Performance Parameters <math>\leq 0</math> or <math>&gt;100</math></p> <p>16: Follow Feedforward Compensation <math>&lt;0</math> or <math>&gt;100</math></p> <p>17: Follow Multiplication Coefficient and Division Coefficient Ratio <math>\leq 0</math> or <math>&gt;100</math></p> <p>20: Interpolation Direction Terminal Not Set or Set Error</p> <p>21: The default maximum interpolation speed is 0</p> <p>22: Arc interpolation data error</p> <p>23: Arc radius data error</p> <p>24: Three-point Arc Data Error</p> <p>25: In polar coordinate mode, the current position is (0, 0)</p> <p>26: Control block allocation failed</p>	
SD1151	Error pulse data block number		
SD1160	Present segment (represents segment n)		
SD1161			
SD1162	Present pulse number low 16-bit (the unit is pulse number)		PULSE_9
SD1163	Present pulse number high 16-bit (the unit is pulse number)		
SD1164	Present pulse number low 16-bit (the unit is pulse equivalent)		

SD1165	Present pulse number high 16-bit (the unit is pulse equivalent)		
SD1166	Present pulse number low 16-bit (the unit is pulse number)		
SD1167	Present pulse number high 16-bit (the unit is pulse number)		
SD1168	Present pulse number low 16-bit (the unit is pulse equivalent)		
SD1169	Present pulse number high 16-bit (the unit is pulse equivalent)		
SD1170	Pulse error information	<p>1: pulse data segment configuration error</p> <p>2: In equivalent mode, the number of pulses per rotation and the movement per rotation is 0</p> <p>3: System parameter block number error</p> <p>4: Pulse parameter block number exceeding maximum limit</p> <p>5: Stop after encountering positive limit signal</p> <p>6: Stop after meeting the negative limit signal</p> <p>10: No origin signal is set for origin regression</p> <p>11: Velocity of origin regression VH is 0</p> <p>12: Origin regression crawling speed VC is 0 or <math>VC \geq VH</math></p> <p>13: Origin regression signal error</p> <p>15: Follow Performance Parameters <math>\leq 0</math> or <math>&gt;100</math></p> <p>16: Follow Feedforward Compensation <math>&lt;0</math> or <math>&gt;100</math></p> <p>17: Follow Multiplication Coefficient and Division Coefficient Ratio <math>\leq 0</math> or <math>&gt;100</math></p> <p>20: Interpolation Direction Terminal Not Set or Set Error</p> <p>21: The default maximum interpolation speed is 0</p> <p>22: Arc interpolation data error</p> <p>23: Arc radius data error</p> <p>24: Three-point Arc Data Error</p> <p>25: In polar coordinate mode, the current position is (0, 0)</p> <p>26: Control block allocation failed</p>	
SD1171	Error pulse data block		

	number		
SD1180	Present segment (represents segment n)		
SD1181			
SD1182	Present pulse number low 16-bit (the unit is pulse number)		
SD1183	Present pulse number high 16-bit (the unit is pulse number)		
SD1184	Present pulse number low 16-bit (the unit is pulse equivalent)		
SD1185	Present pulse number high 16-bit (the unit is pulse equivalent)		
SD1186	Present pulse number low 16-bit (the unit is pulse number)		
SD1187	Present pulse number high 16-bit (the unit is pulse number)		
SD1188	Present pulse number low 16-bit (the unit is pulse equivalent)		
SD1189	Present pulse number high 16-bit (the unit is pulse equivalent)		
SD1190	Pulse error information	<p>1: pulse data segment configuration error</p> <p>2: In equivalent mode, the number of pulses per rotation and the movement per rotation is 0</p> <p>3: System parameter block number error</p> <p>4: Pulse parameter block number exceeding maximum limit</p> <p>5: Stop after encountering positive limit signal</p> <p>6: Stop after meeting the negative limit signal</p> <p>10: No origin signal is set for origin regression</p> <p>11: Velocity of origin regression VH is 0</p> <p>12: Origin regression crawling speed VC is 0 or <math>VC \geq VH</math></p> <p>13: Origin regression signal error</p> <p>15: Follow Performance Parameters <math>\leq 0</math> or <math>&gt;100</math></p> <p>16: Follow Feedforward Compensation <math>&lt;0</math> or <math>&gt;100</math></p>	PULSE- _10

		17: Follow Multiplication Coefficient and Division Coefficient Ratio $\leq 0$ or $> 100$ 20: Interpolation Direction Terminal Not Set or Set Error 21: The default maximum interpolation speed is 0 22: Arc interpolation data error 23: Arc radius data error 24: Three-point Arc Data Error 25: In polar coordinate mode, the current position is (0, 0) 26: Control block allocation failed	
SD1191	Error pulse data block number		

#### High speed pulse special data register HSD (power off memory)

Register	Function	Note	
HSD0	Low 16 bits of cumulative pulse (the unit is pulse number)		PULSE_1
HSD1	High 16 bits of cumulative pulse (the unit is pulse number)		
HSD2	Low 16 bits of cumulative pulse (the unit is pulse equivalent)		
HSD3	High 16 bits of cumulative pulse (the unit is pulse equivalent)		
HSD4	Low 16 bits of cumulative pulse (the unit is pulse number)		PULSE_2
HSD5	High 16 bits of cumulative pulse (the unit is pulse number)		
HSD6	Low 16 bits of cumulative pulse (the unit is pulse equivalent)		
HSD7	High 16 bits of cumulative pulse (the unit is pulse equivalent)		
HSD8	Low 16 bits of cumulative pulse (the unit is pulse number)		PULSE_3
HSD9	High 16 bits of cumulative pulse (the unit is pulse number)		
HSD10	Low 16 bits of cumulative pulse (the unit is pulse equivalent)		
HSD11	High 16 bits of cumulative pulse (the unit is pulse equivalent)		

HSD12	Low 16 bits of cumulative pulse (the unit is pulse number)		
HSD13	High 16 bits of cumulative pulse (the unit is pulse number)		
HSD14	Low 16 bits of cumulative pulse (the unit is pulse equivalent)		
HSD15	High 16 bits of cumulative pulse (the unit is pulse equivalent)		PULSE_4
HSD16	Low 16 bits of cumulative pulse (the unit is pulse number)		
HSD17	High 16 bits of cumulative pulse (the unit is pulse number)		
HSD18	Low 16 bits of cumulative pulse (the unit is pulse equivalent)		
HSD19	High 16 bits of cumulative pulse (the unit is pulse equivalent)		PULSE_5
HSD20	Low 16 bits of cumulative pulse (the unit is pulse number)		
HSD21	High 16 bits of cumulative pulse (the unit is pulse number)		
HSD22	Low 16 bits of cumulative pulse (the unit is pulse equivalent)		
HSD23	High 16 bits of cumulative pulse (the unit is pulse equivalent)		PULSE_6
HSD24	Low 16 bits of cumulative pulse (the unit is pulse number)		
HSD25	High 16 bits of cumulative pulse (the unit is pulse number)		
HSD26	Low 16 bits of cumulative pulse (the unit is pulse equivalent)		
HSD27	High 16 bits of cumulative pulse (the unit is pulse equivalent)		PULSE_7
HSD28	Low 16 bits of cumulative pulse (the unit is pulse number)		
HSD29	High 16 bits of cumulative pulse (the unit is pulse number)		
HSD30	Low 16 bits of cumulative pulse (the unit is pulse equivalent)		
HSD31	High 16 bits of cumulative pulse (the unit is pulse equivalent)		PULSE_8
HSD32	Low 16 bits of cumulative pulse (the unit is pulse number)		PULSE_9

HSD33	High 16 bits of cumulative pulse (the unit is pulse number)		
HSD34	Low 16 bits of cumulative pulse (the unit is pulse equivalent)		
HSD35	High 16 bits of cumulative pulse (the unit is pulse equivalent)		
HSD36	Low 16 bits of cumulative pulse (the unit is pulse number)		
HSD37	High 16 bits of cumulative pulse (the unit is pulse number)		
HSD38	Low 16 bits of cumulative pulse (the unit is pulse equivalent)		
HSD39	High 16 bits of cumulative pulse (the unit is pulse equivalent)		PULSE_10



# 2 Motion control

## 2-1. Motion control instruction list

The following motion control instructions are suitable for XDM, XDME, XLME series PLC.

Instruction	Function	Chapter
DRV	Quick positioning	2-4-1
DRVR	Quick positioning, polar coordinate mode (temporarily unavailable)	2-4-2
LIN line	Linear interpolation	2-4-3
LIN line VM	Linear interpolation, maximum speed can be specified separately	2-4-3
LIN line VBEM	Linear interpolation, can specify the starting speed, terminal speed and maximum speed separately	2-4-3
CW clockwise	Clockwise circular interpolation	2-4-4
CW closewise VM	Clockwise circular interpolation, maximum speed can be specified separately	2-4-4
CW closewise VBEM	Clockwise circular interpolation, can specify the starting speed, terminal speed and maximum speed separately	2-4-4
CCW anticlockwise	Anticlockwise circular interpolation	2-4-5
CCW anticlockwise VM	Anticlockwise circular interpolation, maximum speed can be specified separately	2-4-5
CCW anticlockwise VBEM	Anticlockwise circular interpolation, can specify the starting speed, terminal speed and maximum speed separately	2-4-5
CW_R closewise	Clockwise circular interpolation (Specified radius)	2-4-6
CW_R closewise VM	Clockwise circular interpolation(Specified radius), maximum speed can be specified separately	2-4-6
CW_R closewise VBEM	Clockwise circular interpolation(Specified radius), can specify the starting speed, terminal speed and maximum speed separately	2-4-6
CCW_R anticlockwise	Anticlockwise circular interpolation(Specified radius)	2-4-7
CCW_R anticlockwise VM	Anticlockwise circular interpolation(Specified radius), maximum speed can be specified separately	2-4-7
CCW_R anticlockwise VBEM	Anticlockwise circular interpolation(Specified radius), can specify the starting speed, terminal speed and maximum speed separately	2-4-7

ARC three points	Three points arc	2-4-8
ARC three point VM	Three points arc, maximum speed can be specified separately	2-4-8
ARC three point VBEM	Three points arc, can specify the starting speed, terminal speed and maximum speed separately	2-4-8
FOLLOW	Single phase follow	2-4-9
FOLLOW_AB	AB phase follow	2-4-9

**Note: All interpolation instructions have no stop when jumping, there is inflection point.**

## 2-2. Writing method of motion control instruction

Except FOLLOW, other motion control instructions must be written in the BLOCK. The specific methods are as follows:

1. insert a sequence block **S** in the ladder chart, then insert G instruction.

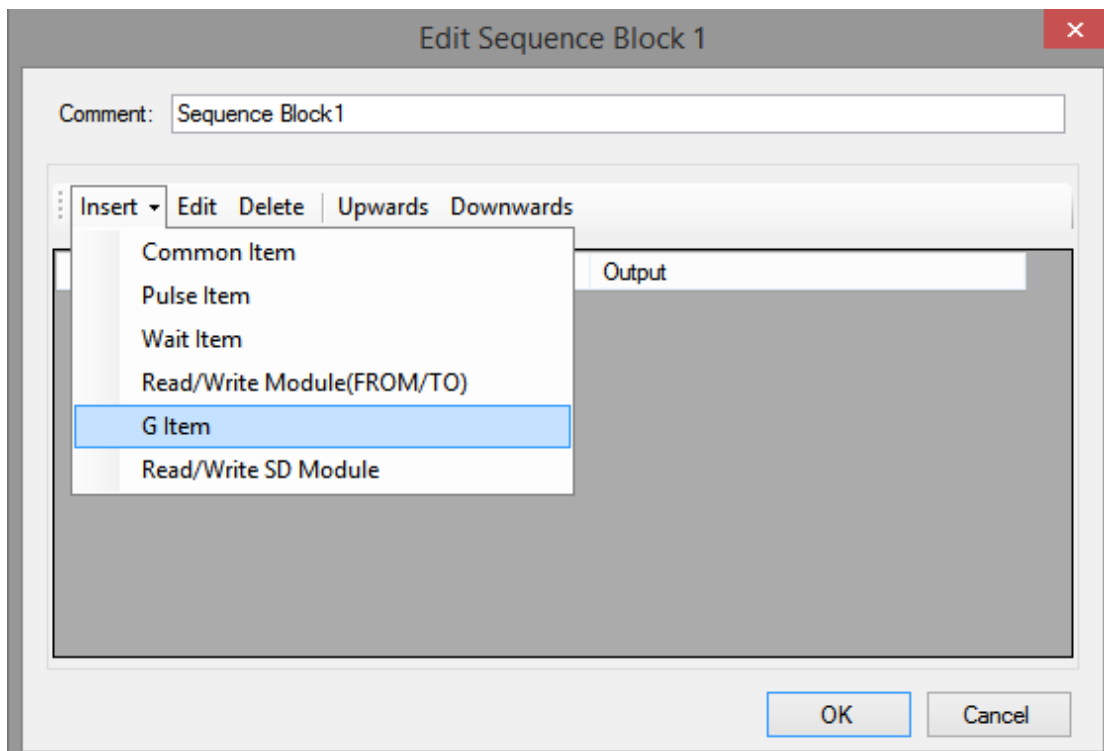

2. it will show the following window

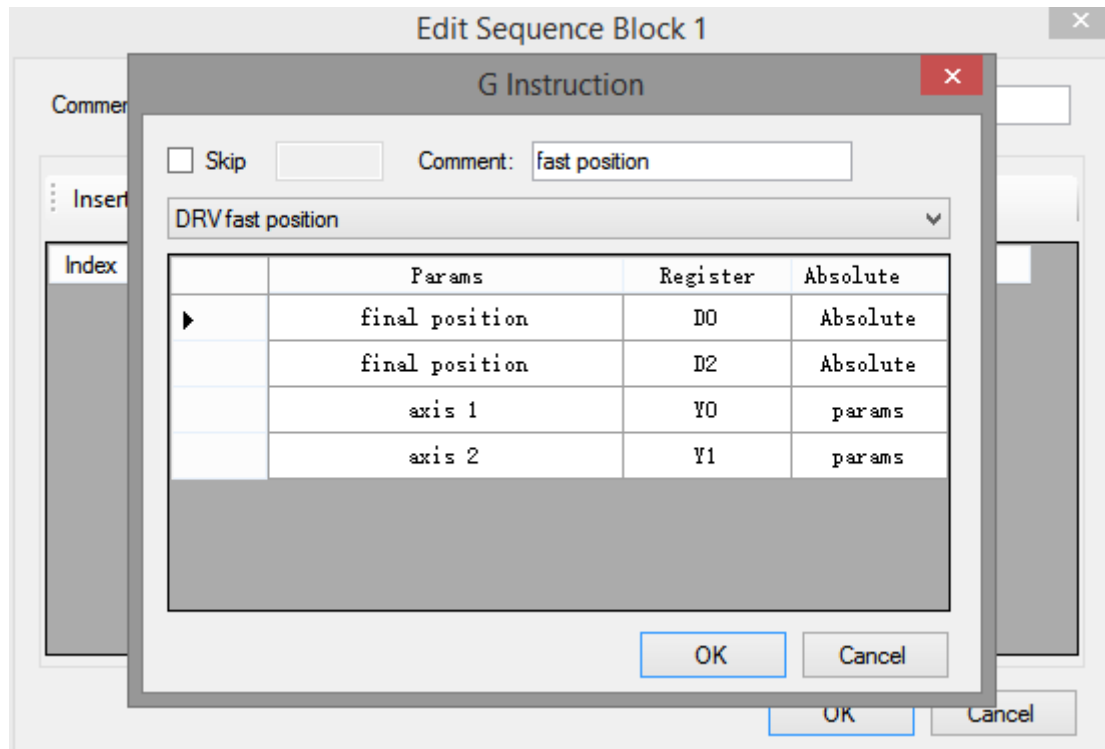

- click the dropdown menu, select the motion control instruction to

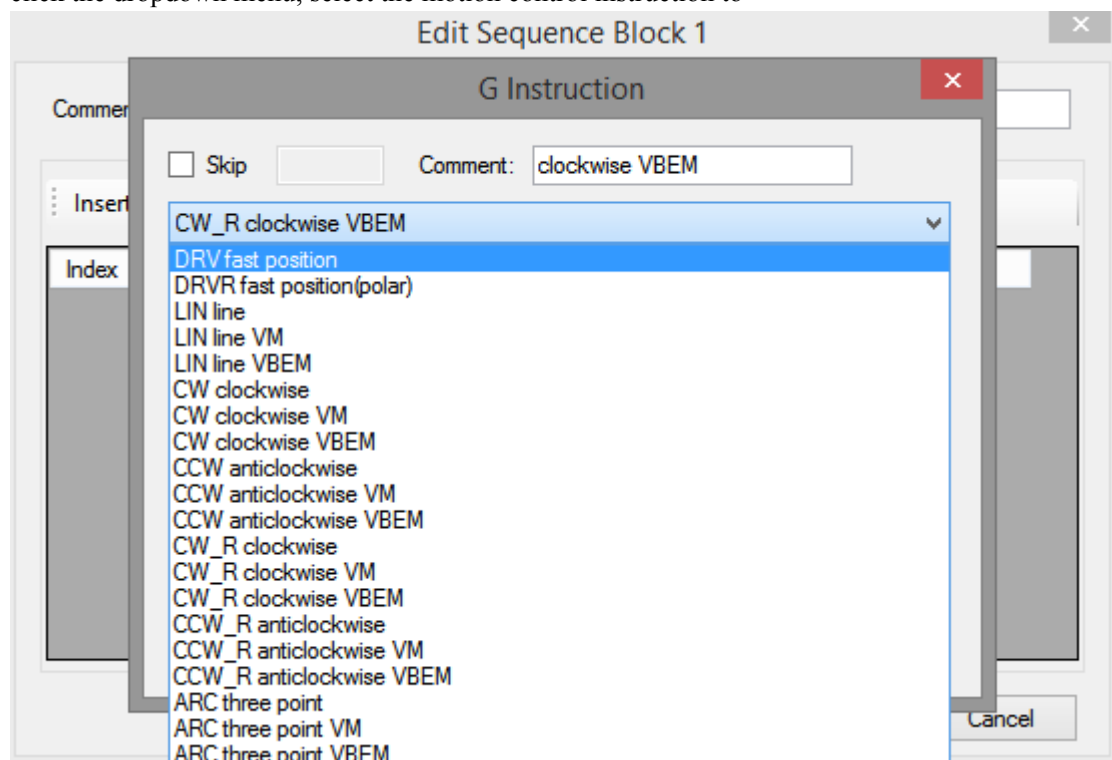

- click the motion control instruction CW clockwise, it will show the instruction configuration window:

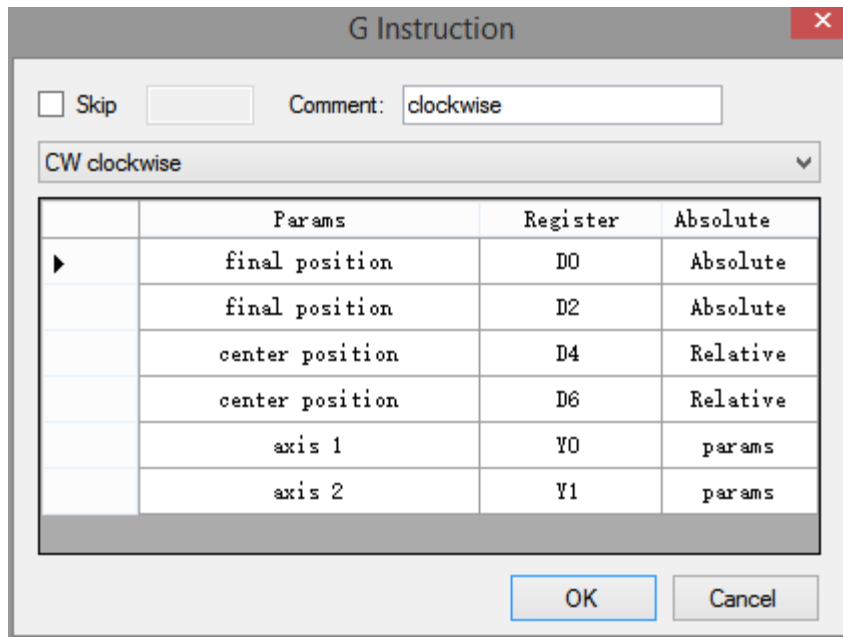

In the register list, double click the value can change the register address and axis output terminal.  
 In the absolute list, double click the value can set the mode (relative/absolute).  
 Double click the parameters can set the direction, speed, acc/dec time of the two axes, please see the follows:

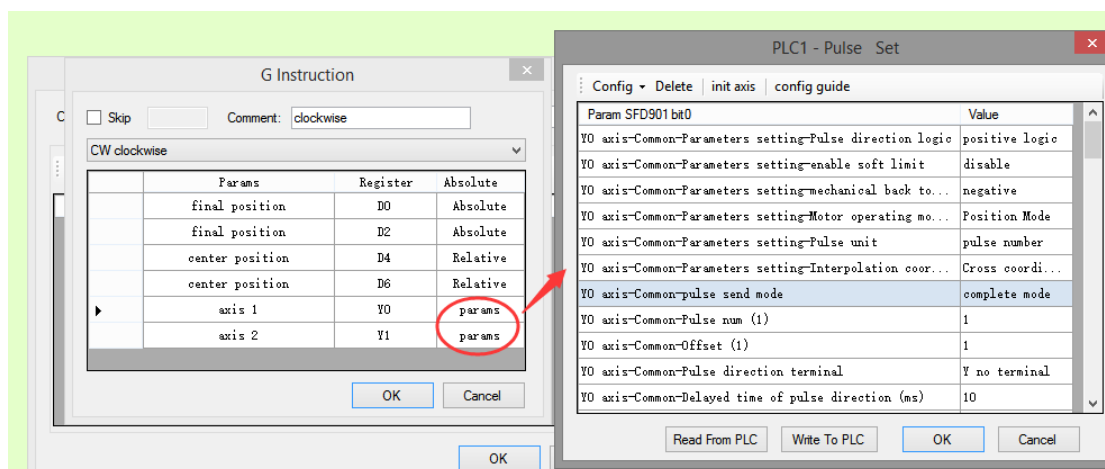

**Note:**

(1) Different instructions require different system parameter blocks. See chapter 2-3-2 and instructions for details.

(2) See chapter 1-2-1 for system parameters.

5. Configuration is completed, click OK, and you can see the general situation of the generated instructions in the SBLOCK:

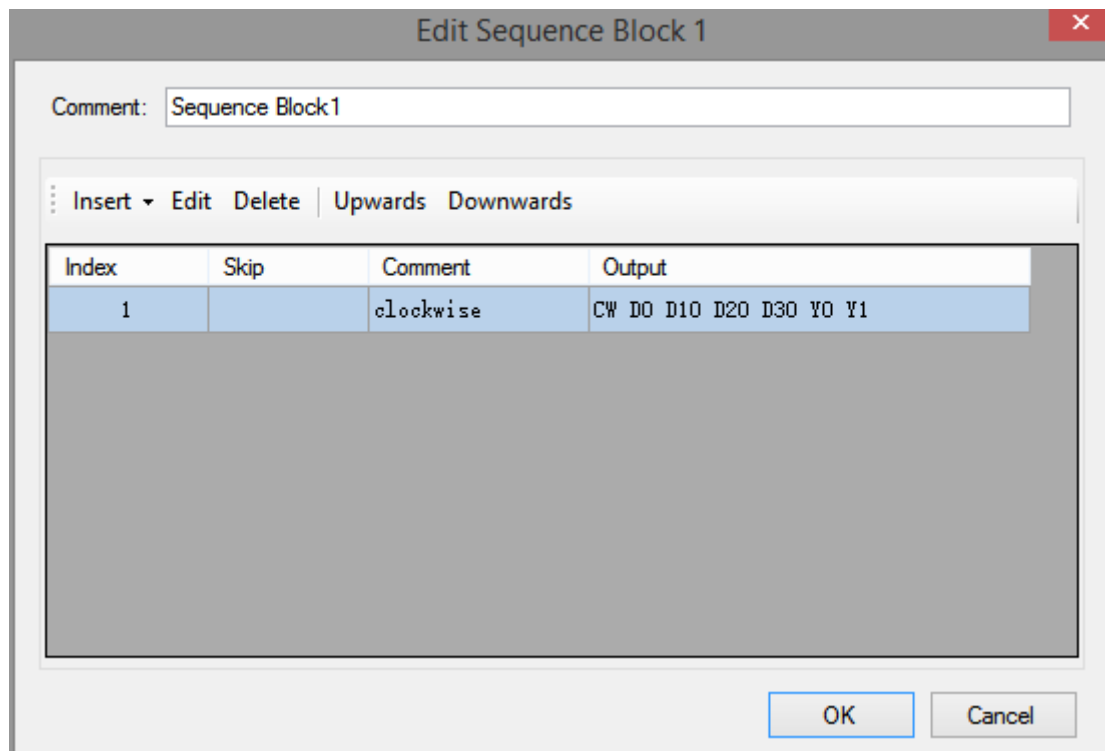

6. A complete motion control instruction is completed by generating the motion control instructions in the ladder diagram and inputting the driving conditions.

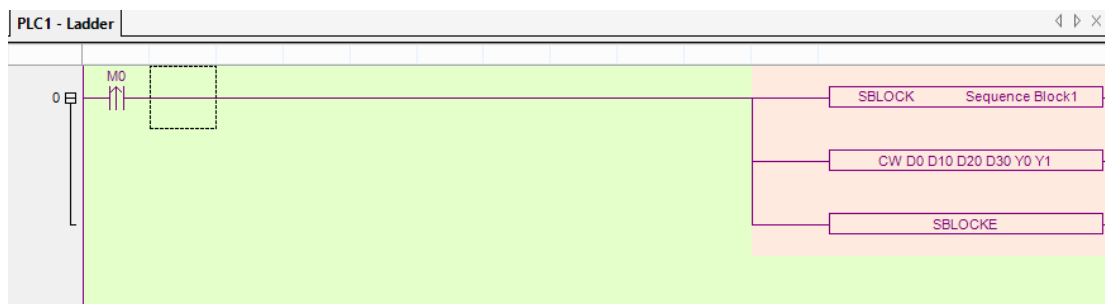

7. Execute BLOCK once every time M0 rises.
8. Multiple motion control instructions can be inserted into BLOCK. Lines and arcs can be used to fulfill different interpolation requirements.

## 2-3. Pulse output terminal distribution and parameters

This section will introduce the distribution of the output port of each PLC pulse in XD series and the configuration of the parameters of each axis pulse.

### 2-3-1. Pulse output port distribution

In all transistor output terminals of XDM series PLC, the operation axes of axle 1 and axle 2 can be arbitrarily specified, and the corresponding direction terminals can also be arbitrarily specified.

#### XDM-24T4

Output	Y0~Y3	Y4~Y11
Function	Pulse output	Direction output

#### XDM-32T4, XLME-32T4

Output	Y0~Y3	Y4~Y15
Function	Pulse output	Direction output

#### XDM-60T4, XDM-60T4L, XDME-60T4, XDH-60T4

Output	Y0~Y3	Y4~Y27
Function	Pulse output	Direction output

#### XDM-60T10, XDME-60T10

Output	Y0~Y11	Y12~Y27
Function	Pulse output	Direction output

**Note:** Pulse output terminals that are not used can also be used as directional terminals.

### 2-3-2. Pulse output terminal parameters

In order to execute the motion control command, it is necessary to configure the pulse control parameters of axis 1 and axis 2. However, only part of the pulse parameters are used in the motion control command, and part of these parameters are common parameters of two axes (i.e. the parameters configured in axis 1 are valid). As shown in the following figure:

Common parameter	Pulse direction logic	Independent parameter	Axis 1 and 2 need to be set
	Enable soft limit	Common parameter	Only need to set axis 1
	Pulse unit	Common parameter	Only need to set axis 1
	Pulse number	Independent	Axis 1 and 2 need to be set

		parameter	
	Offset	Independent parameter	Axis 1 and 2 need to be set
	Pulse direction terminal	Independent parameter	Axis 1 and 2 need to be set
	Signal terminal switch state setting---positive limit	Independent parameter	Axis 1 and 2 need to be set
	Signal terminal switch state setting---negative limit	Independent parameter	Axis 1 and 2 need to be set
	Positive limit terminal setting	Independent parameter	Axis 1 and 2 need to be set
	Negative limit terminal setting	Independent parameter	Axis 1 and 2 need to be set
	Soft limit positive value	Independent parameter	Axis 1 and 2 need to be set
	Soft limit negative value	Independent parameter	Axis 1 and 2 need to be set
Group 2 parameters	Pulse default speed	Common parameter	Only need to set axis 1
	Acceleration time of pulse default speed	Common parameter	Only need to set axis 1
	Deceleration time of pulse default speed	Common parameter	Only need to set axis 1
	Max speed	Common parameter	Only need to set axis 1
	Initial speed	Common parameter	Only need to set axis 1
	Stop speed	Common parameter	Only need to set axis 1

**Note: The above table is applicable to all motion control instructions except DRV and DRVR.**

**DRV and DRVR instructions used parameters:**

Common parameters	Pulse direction logic	Independent parameter	Axis 1 and 2 need to be set
	Enable soft limit	Common parameter	Only need to set axis 1
	Pulse unit	Common parameter	Only need to set axis 1
	Pulse number	Independent parameter	Axis 1 and 2 need to be set
	Offset	Independent parameter	Axis 1 and 2 need to be set
	Pulse direction terminal	Independent	Axis 1 and 2 need to be set

		parameter	
	Signal terminal switch state setting---positive limit	Independent parameter	Axis 1 and 2 need to be set
	Signal terminal switch state setting---negative limit	Independent parameter	Axis 1 and 2 need to be set
	Positive limit terminal setting	Independent parameter	Axis 1 and 2 need to be set
	Negative limit terminal setting	Independent parameter	Axis 1 and 2 need to be set
	Soft limit positive value	Independent parameter	Axis 1 and 2 need to be set
	Soft limit negative value	Independent parameter	Axis 1 and 2 need to be set
Group 1 parameters	Pulse default speed	Common parameter	Axis 1 and 2 need to be set
	Acceleration time of pulse default speed	Common parameter	Axis 1 and 2 need to be set
	Deceleration time of pulse default speed	Common parameter	Axis 1 and 2 need to be set
	Max speed	Common parameter	Axis 1 and 2 need to be set
	Initial speed	Common parameter	Axis 1 and 2 need to be set
	Stop speed	Common parameter	Axis 1 and 2 need to be set

**Note: For a detailed description of the pulse parameters, please refer to the relevant content of Chapter 1.**



## 2-4. Motion control instruction

### 2-4-1. Quick positioning [DRV]

#### 1. instruction overview

Quick positioning instructions. This instruction can only be used in BLOCK. See Section 2-2 for specific usage.

Quick positioning [DRV]			
16-bit instruction	-	32-bit instruction	DRV
Execute condition	Rise/fall edge of coil	Suitable model	XDM, XDME, XLME, XDH
Firmware	V3.3 and above	Software	V3.3 and above

#### 2. operand

Operand	Function	Type
S0	The target position of axis 1	Double words, 32-bit
S1	The target position of axis 2	Double words, 32-bit
D0	Pulse output terminal of axis 1	Bit
D1	Pulse output terminal of axis 2	Bit

#### 3. suitable soft component

Word	Operand	System								Constant	Module	
		D*	FD	TD*	CD*	DX	DY	DM*	DS*	K/H	ID	QD
	S0	•	•	•	•							
	S1	•	•	•	•							
Bit	Operand	System										
		X	Y	M*	S*	T*	C*	Dnm				
	D0		•									
	D1		•									

\* Note: D denotes D HD; TD denotes TD HTD; CD denotes CD HCD HSCD HSD; DM denotes DM DHM; DS denotes DS DHS; M denotes M HM SM; S denotes S HS; T denotes T HT; C denotes C HC.

#### 4. Parameter setting

Relative parameters	Settings	Note
Final position	Free to specify register address	Must set
Relative/ absolute	Relative: the above position as a reference; absolute: the origin as a reference	Must set
Axis 1 pulse output port	Free to specify pulse output terminal	Must set
Axis 2 pulse output	Free to specify pulse output terminal	Must set

port		
Axis 1 direction port	Arbitrarily specify idle output points, set in system parameters	Must set
Axis 2 direction port	Arbitrarily specify idle output points, set in system parameters	Must set
Pulse unit	Setting in System Parameters of Axis 1	Must set
Pulse default speed	Specify in group 1 parameters of the system parameters of each axis	Must set
Acceleration time	Specify in group 1 parameters of the system parameters of each axis	No need to set
Deceleration time	Specify in group 1 parameters of the system parameters of each axis	No need to set

### Function and action

《Instruction format》

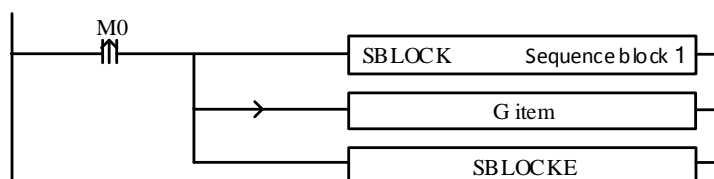

When the quick positioning DRV command is executed, the two axes will move rapidly from the current position to the target position at the default pulse speed set by their respective axes (when one axis is finished first, the other axis will continue to move at the default pulse speed, and then finish positioning after reaching the target position). As shown in the following figure:

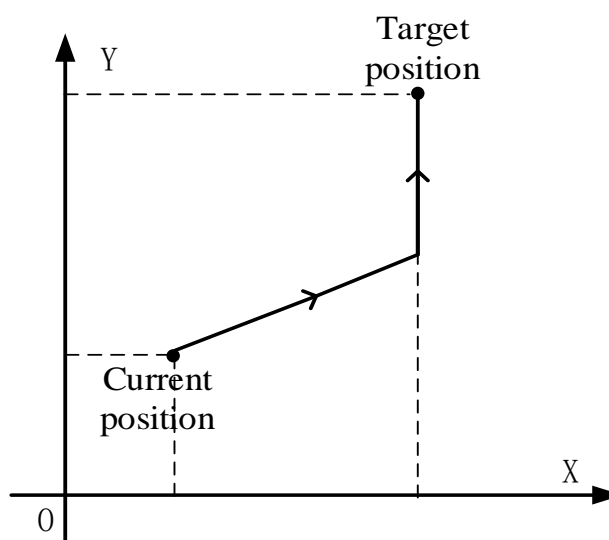

DRV quick positioning

## Parameter configuration

Double click G item, it will pop up the DRV configuration panel:

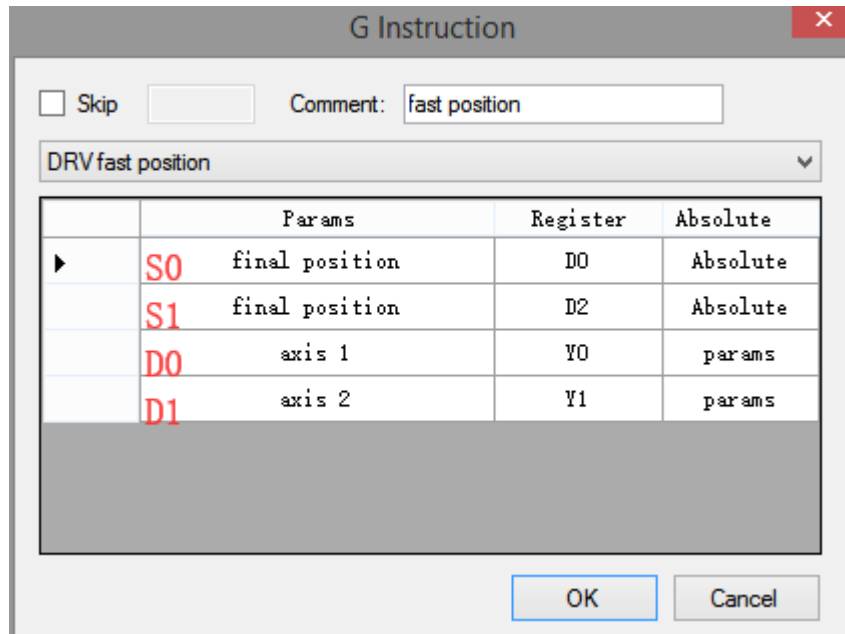

## Command configuration

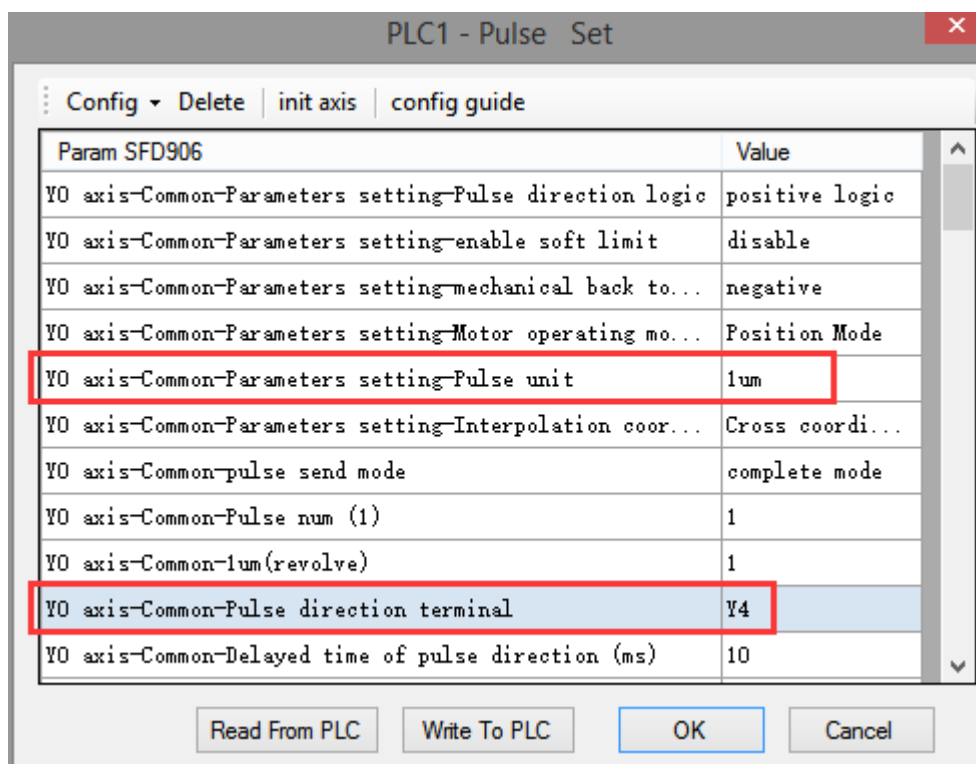

## Y0 axis system parameters (1)

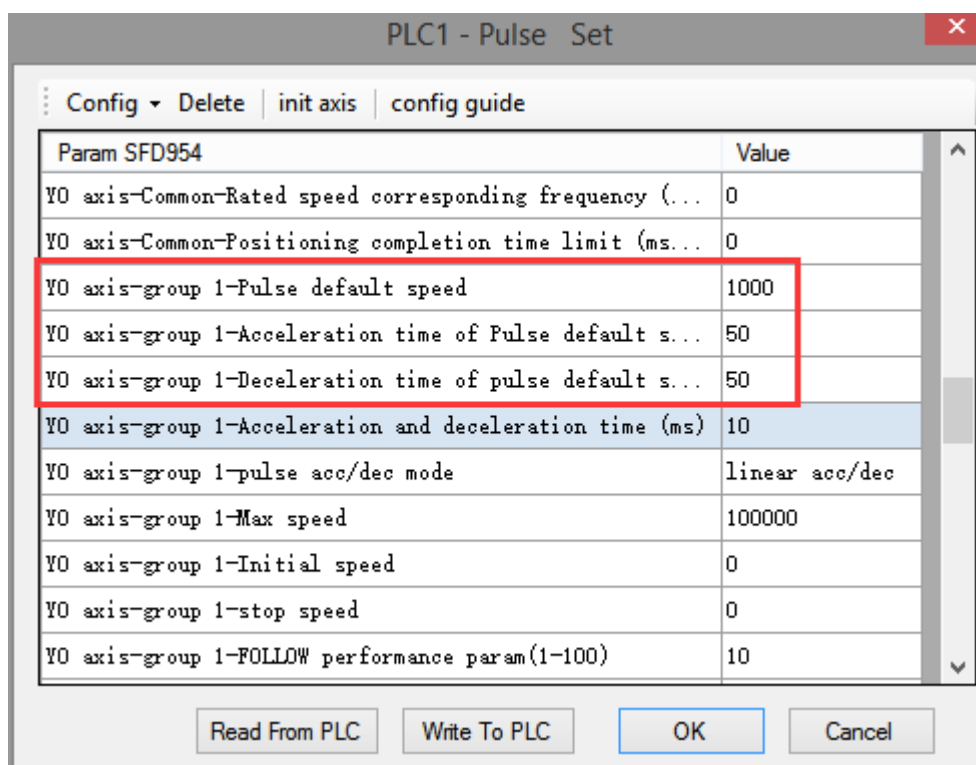

Y0 axis system parameters (2)

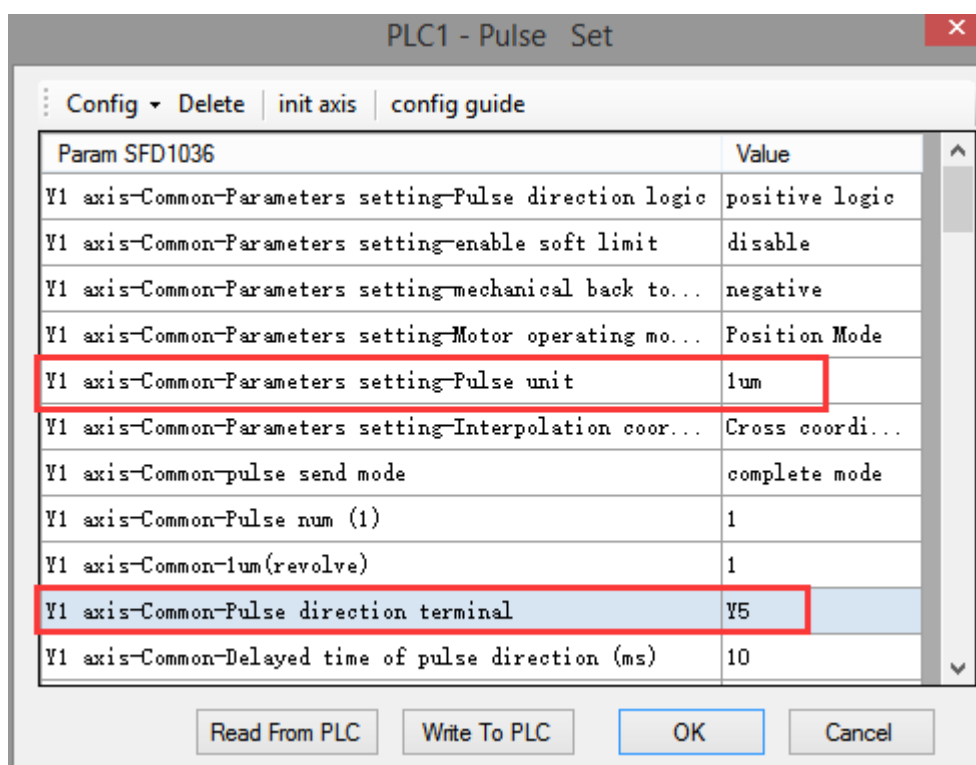

Y1 axis system parameters (1)

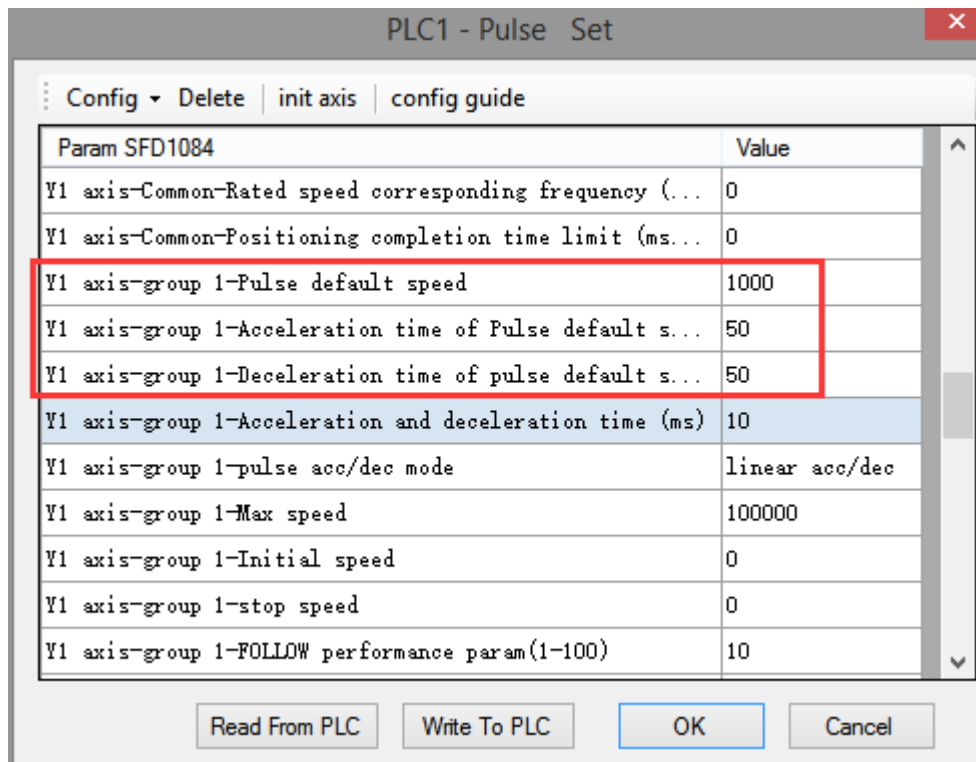

Y1 axis system parameters (2)

- As shown in the figure, D0 specifies the final position of axis 1 and D10 specifies the final position of axis 2.
- Y0 is the pulse output port of axis 1 and Y1 is the pulse output port of axis 2. See Sections 2-3 for other optional ports.
- The directional terminals are Y4 and Y5, it is set ON for the forward pulse and set OFF for the reverse pulse.
- Pulse frequency range: 1Hz ~ 100KHz; Acceleration and deceleration time: 0 ~ 65535ms.
- Position movement can be viewed in equivalent cumulative registers HSD2 and HSD6.
- Assuming HSD2 = 500, HSD6 = 1000, D0 = 5000, D10 = 2000, when M0 rises, execute DRV instructions and move to the target position with 1000 Hz, 50ms acceleration/deceleration time, if:
  - (1) If the final position is absolute mode, the target position is (5000,2000);
  - (2) When the final position is in the relative mode, the target position is (5500,3000).
- When the DRV instruction is running, the pulse flag bit corresponding to the output port Y of the DRV instruction will be set on.

**Note: DRV instructions are fixed using group 1 parameters!**



As shown in the figure below, the current position coordinates of the worktable are (1000,1000) and the target coordinates are (5000,8000). The two axes are Y0 and Y1, respectively. The default pulse speeds are all 5000. The acceleration and deceleration slopes are changed by 1000Hz for 30ms, and the

pulse direction terminals are Y4 and Y5. Note: The above numerical units are pulse numbers.

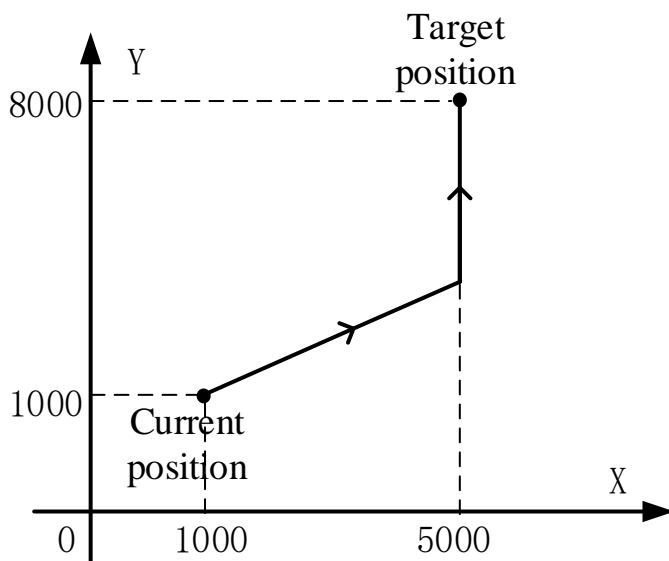

Ladder chart:

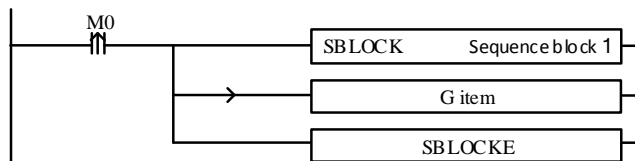

G item configurations:

**G Instruction** ✕

Skip        Comment:

DRV fast position ▾

	Params	Register	Absolute
	final position	K5000	Absolute
	final position	K3000	Absolute
▶	axis 1	Y0	params
	axis 2	Y1	params

Absolute mode

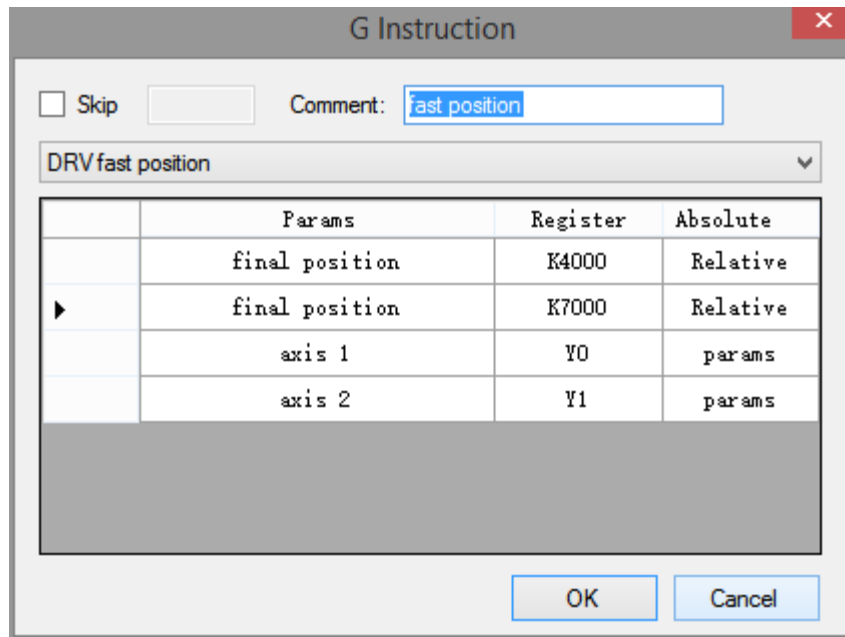

Relative mode

Axis 1(Y0) parameters:

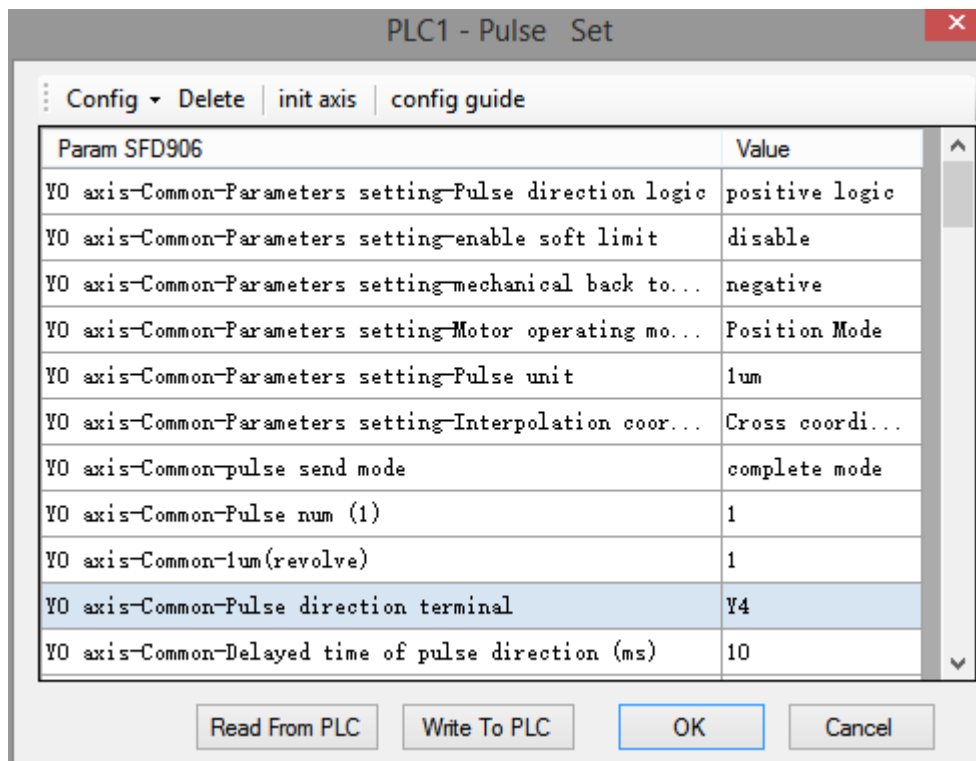

PLC1 - Pulse Set

Config ▾ Delete | init axis | config guide

Param SFD906	Value
Y0 axis-Common-Gear clearance positive compensation	0
Y0 axis-Common-Gear clearance negative compensation	0
Y0 axis-Common-Electrical origin position	0
Y0 axis-Common-signal terminal switch state setting...	normally on
Y0 axis-Common-signal terminal switch state setting...	normally on
Y0 axis-Common-signal terminal switch state setting...	normally on
Y0 axis-Common-signal terminal switch state setting...	normally on
Y0 axis-Common-Far-point signal terminal setting	X no terminal
Y0 axis-Common-Z phase terminal setting	X no terminal
Y0 axis-Common-positive limit terminal setting	X no terminal
Y0 axis-Common-negative limit terminal setting	X no terminal

Read From PLC Write To PLC OK Cancel

PLC1 - Pulse Set

Config ▾ Delete | init axis | config guide

Param SFD924(dword)	Value
Y0 axis-Common-negative limit terminal setting	X no terminal
Y0 axis-Common-Zero clear CLR output setting	Y no terminal
Y0 axis-Common-Return speed VH	0
Y0 axis-Common-Creeping speed VC	0
Y0 axis-Common-Mechanical zero position	0
Y0 axis-Common-Z phase num	0
Y0 axis-Common-CLR signal delayed time (ms)	20
Y0 axis-Common-grinding wheel radius(polar Interpola...	0
Y0 axis-Common-soft limit positive value	0
Y0 axis-Common-soft limit negative value	0
Y0 axis-Common-encoder pulse number/1 rotate(closed...	1

Read From PLC Write To PLC OK Cancel



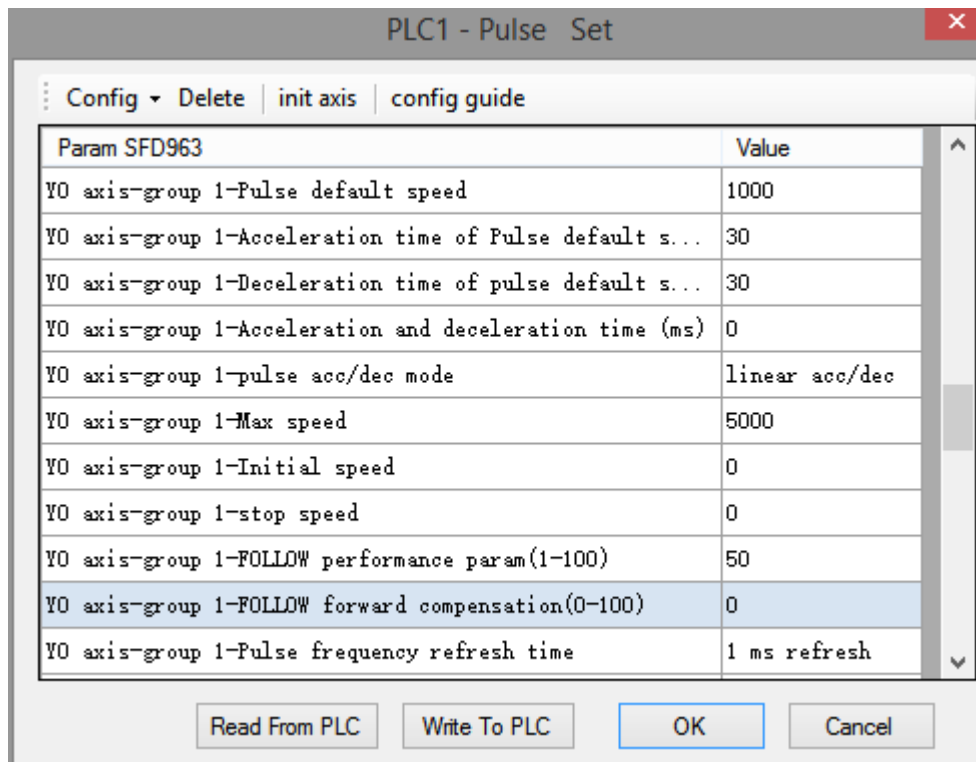

Axis 2 (Y1) parameters:

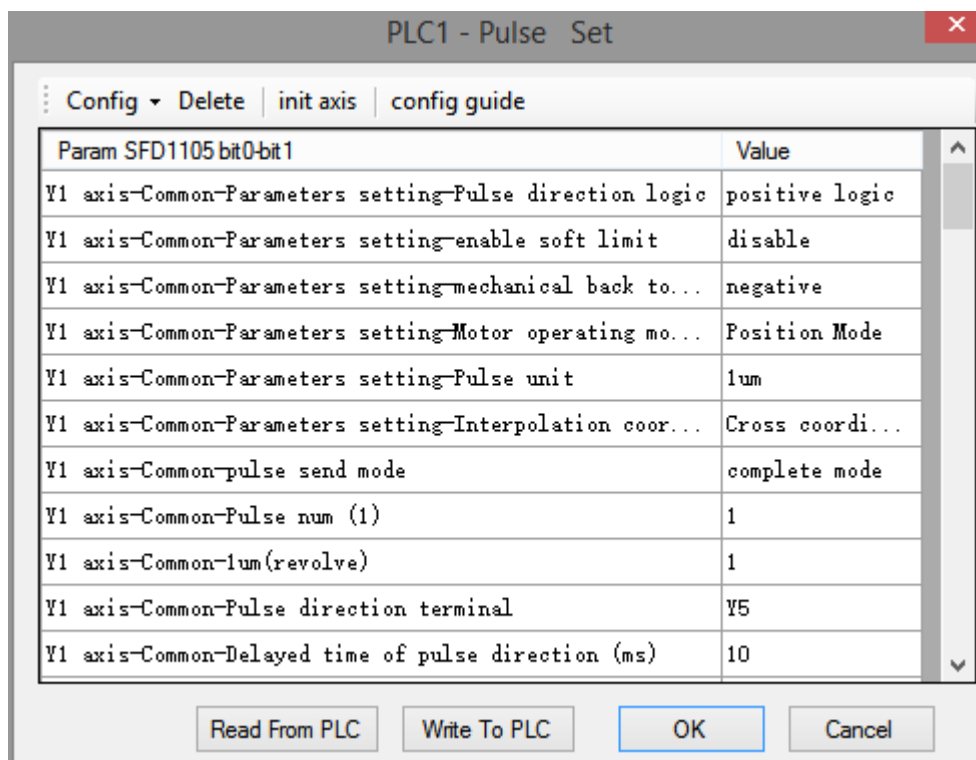

PLC1 - Pulse Set

Config ▾ Delete | init axis | config guide

Param SFD1105 bit0-bit1	Value
Y1 axis-Common-Gear clearance positive compensation	0
Y1 axis-Common-Gear clearance negative compensation	0
Y1 axis-Common-Electrical origin position	0
Y1 axis-Common-signal terminal switch state setting...	normally on
Y1 axis-Common-signal terminal switch state setting...	normally on
Y1 axis-Common-signal terminal switch state setting...	normally on
Y1 axis-Common-signal terminal switch state setting...	normally on
Y1 axis-Common-Far-point signal terminal setting	X no terminal
Y1 axis-Common-Z phase terminal setting	X no terminal
Y1 axis-Common-positive limit terminal setting	X no terminal
Y1 axis-Common-negative limit terminal setting	X no terminal

Read From PLC Write To PLC OK Cancel

PLC1 - Pulse Set

Config ▾ Delete | init axis | config guide

Param SFD1054(dword)	Value
Y1 axis-Common-negative limit terminal setting	X no terminal
Y1 axis-Common-Zero clear CLR output setting	Y no terminal
Y1 axis-Common-Return speed VH	0
Y1 axis-Common-Creeping speed VC	0
Y1 axis-Common-Mechanical zero position	0
Y1 axis-Common-Z phase num	0
Y1 axis-Common-CLR signal delayed time (ms)	20
Y1 axis-Common-grinding wheel radius(polar Interpola...	0
Y1 axis-Common-soft limit positive value	0
Y1 axis-Common-soft limit negative value	0
Y1 axis-Common-encoder pulse number/1 rotate(closed...	1

Read From PLC Write To PLC OK Cancel

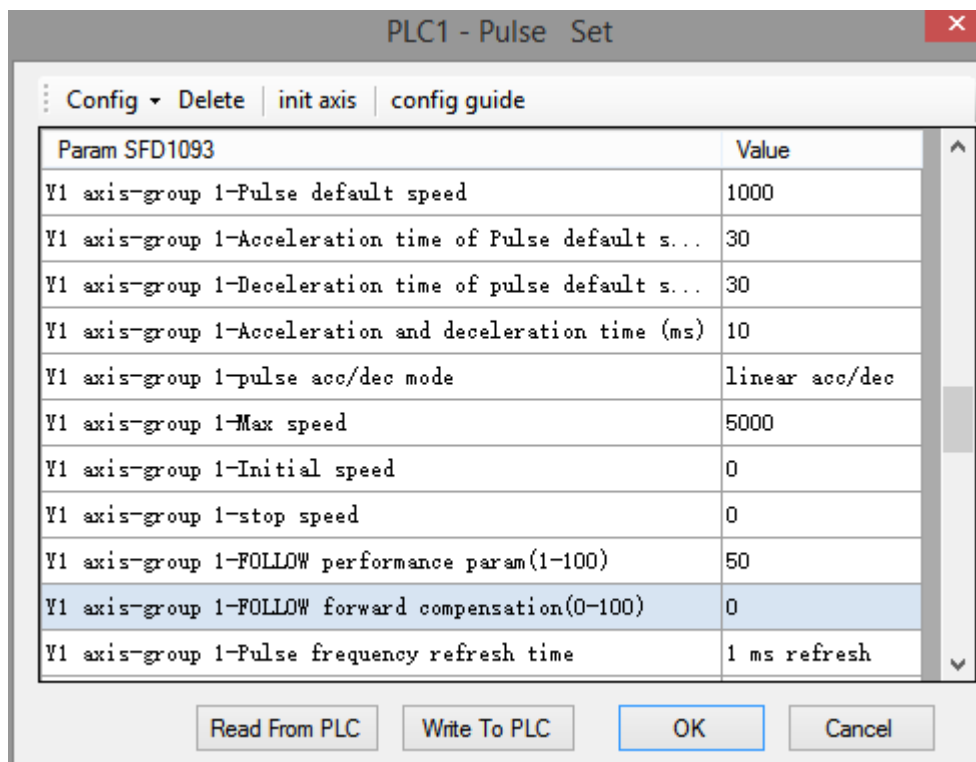

### 2-4-2. Quick positioning (polar coordinates) [DRVR]

#### 1. Instruction overview

Quick positioning (polar coordinates) instructions. This instruction can only be used in BLOCK. See Section 2-2 for specific usage.

Quick positioning [DRVR]			
16-bit instruction	-	32-bit instruction	DRVR
Execute condition	Rise/fall edge of the coil	Suitable model	XDM, XDME, XLME, XDH
Firmware	V3.3 and above	Software	V3.3 and above

#### 2. Operand

Operand	Function	Type
S0	Axis X target position	Double words, 32-bit
S1	Axis Y target position	Double words, 32-bit
D0	Pulse output port of axis X	Bit
D1	Pulse output port of axis Y	Bit

## 3. suitable soft component

Word	Operand	System								Constant	Module	
		D*	FD	TD*	CD*	DX	DY	DM*	DS*	K/H	ID	QD
S0		•	•	•	•							
S1		•	•	•	•							

Bit	Operand	System						
		X	Y	M*	S*	T*	C*	Dnm
D0			•					
D1			•					

\* Note: D denotes D HD; TD denotes TD HTD; CD denotes CD HCD HSCD HSD; DM denotes DM DHM; DS denotes DS DHS; M denotes M HM SM; S denotes S HS; T denotes T HT; C denotes C HC.

## 4. Parameter setting

Related parameters	Setting	Note
Final position	Free to specify register address	Must set
Relative/absolute	Relative: the above position as a reference; absolute: the origin as a reference	Must set
Pulse output port of axis 1	Arbitrary specify pulse output point	Must set
Pulse output port of axis 2	Arbitrary specify pulse output point	Must set
Direction port of axis 1	Arbitrarily specify idle output points, set in system parameters	Must set
Direction port of axis 2	Arbitrarily specify idle output points, set in system parameters	Must set
Pulse unit	Set in axis 1 system parameters	Must set
Default speed	Set in axis 1 group 1 parameters	Must set
Acceleration time	Set in axis 1 group 1 parameters	No need to set
Deceleration time	Set in axis 1 group 1 parameters	No need to set

**Function and action**

《instruction format》

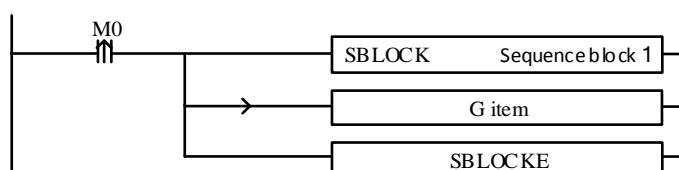

Fast positioning (polar coordinates) instruction refers to the rotation axis of one axis, which rotates the workpiece on the rotating axis, and the forward and backward feed axis which is perpendicular

to the rotating axis. When the rotating axis drives the workpiece to rotate, the feed axis processes the trajectory of the rotating workpiece through forward and backward processing. The trajectory of motion can include straight line and arc, and can be used in processing and grinding equipment.

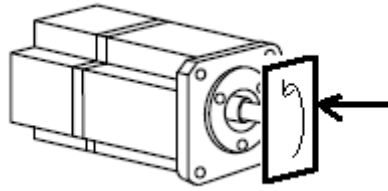

Double click G item, it will pop up DRVR fast position(polar) instruction configuration panel, as shown below:

**G Instruction** [X]

Skip    Comment:

DRVR fast position(polar) [v]

	Params	Register	Absolute
	<b>S0</b> final position	D0	Absolute
	<b>S1</b> final position	D10	Absolute
▶	<b>D0</b> axis 1	Y0	params
	<b>D1</b> axis 2	Y1	params

[OK] [Cancel]

### 2-4-3. Linear interpolation [LIN]

There are three modes of linear interpolation, the following will introduce one by one.

#### Mode 1: LIN line

##### 1. Instruction overview

Linear interpolation instruction, operate according to the set default speed. This instruction can only be used in BLOCK. See Section 2-2 for specific usage.

Linear interpolation [LIN]			
16-bit instruction	-	32-bit instruction	LIN
Execution condition	Rise/fall edge of coil	Suitable model	XDM, XDME, XLME, XDH
Firmware	V3.3 and above	Software	V3.3 and above

##### 2. Operand

Operand	Function	Type
S0	Axis 1 target position	Double words, 32-bit
S1	Axis 2 target position	Double words, 32-bit
D0	Pulse output port of axis 1	Bit
D1	Pulse output port of axis 2	Bit

##### 3. Suitable soft component

Word	Operand	System								Constant	Module	
		D*	FD	TD*	CD*	DX	DY	DM*	DS*	K/H	ID	QD
	S0	•	•	•	•							
	S1	•	•	•	•							
Bit	Operand	System										
		X	Y	M*	S*	T*	C*	Dnm				
	D0		•									
	D1		•									

\* Note: D denotes D HD; TD denotes TD HTD; CD denotes CD HCD HSCD HSD; DM denotes DM DHM; DS denotes DS DHS; M denotes M HM SM; S denotes S HS; T denotes T HT; C denotes C HC.

##### 4. Parameter setting

Related parameters	Setting	Note
Final position	Free to specify register address	Must set
Relative/absolute	Relative: the above position as a reference; absolute: the origin as a reference	Must set
Pulse output port of	Arbitrary specify pulse output point	Must set

axis 1		
Pulse output port of axis 2	Arbitrary specify pulse output point	Must set
Direction port of axis 1	Arbitrarily specify idle output points, set in system parameters	Must set
Direction port of axis 2	Arbitrarily specify idle output points, set in system parameters	Must set
Pulse unit	Set in axis 1 system parameters	Must set
Default speed	The synthetic speed of two axes, set in axis 1 group 2 parameters	Must set
Acceleration time	Set in axis 1 group 2 parameters	No need to set
Deceleration time	Set in axis 1 group 2 parameters	No need to set

### Function and action

《Instruction format》

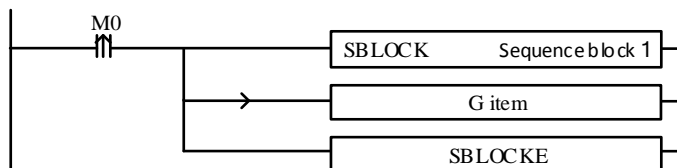

When the LIN instruction of linear interpolation (mode 1) is executed, the two axes will move rapidly from the current position to the target position at the highest synthetic speed of the two axes (the default speed set in axis 1 group 2 parameters). As shown in the following figure:

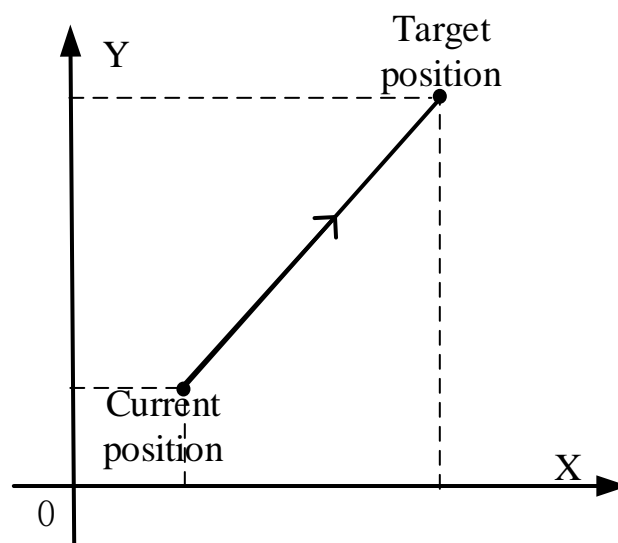

LIN linear interpolation

The parameter configuration is shown in the following figure:  
 Double-click G item and pop up the configuration panel. Set it as follows:

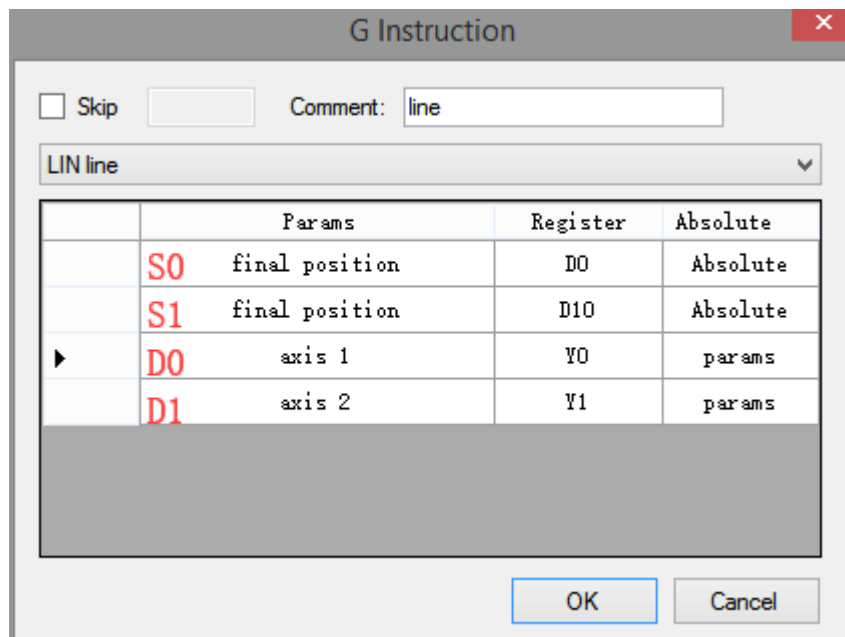

Instruction configuration

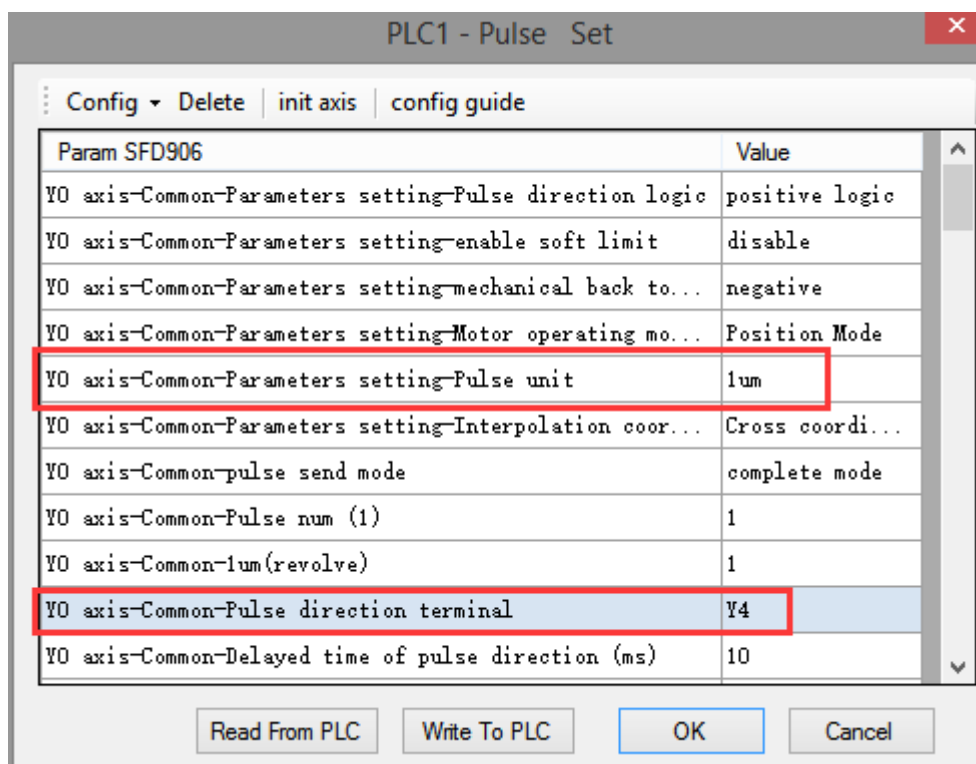

Axis Y0 system parameters (1)



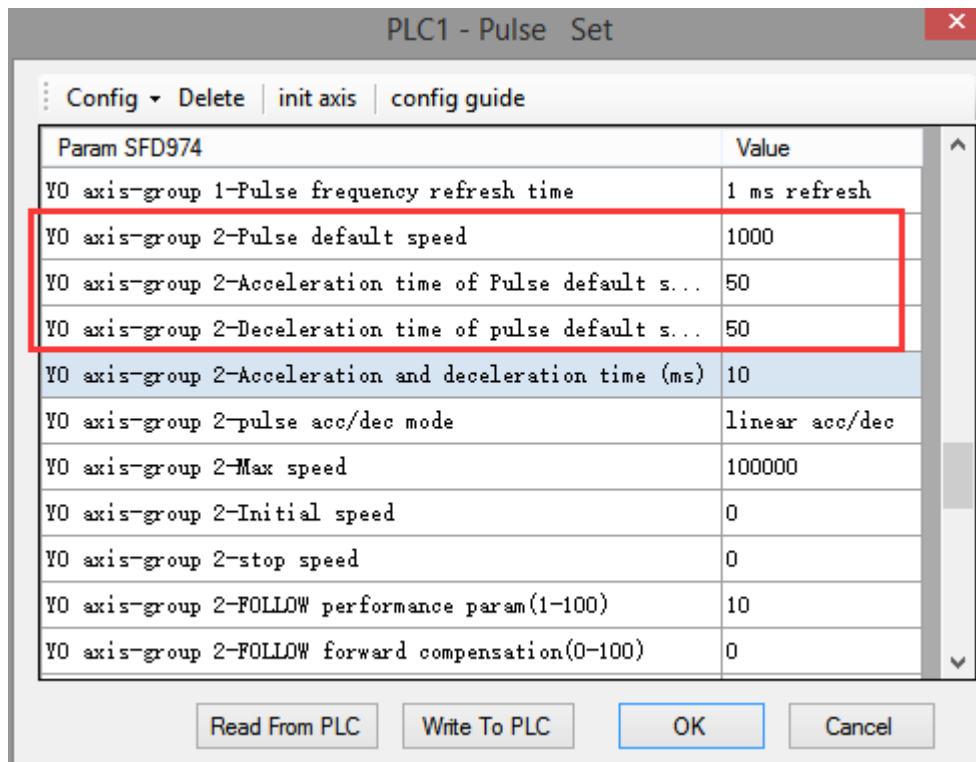

Axis Y0 system parameters (2)

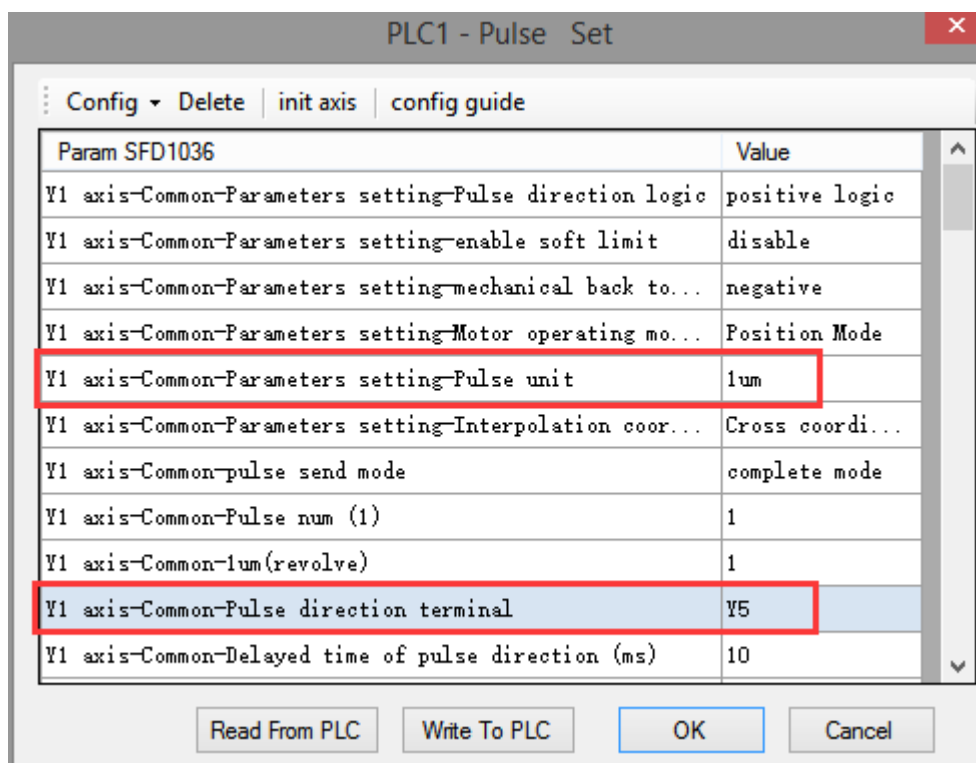

Axis Y1 system parameters

- As shown in the figure, D0 specifies the final position of axis 1 and D10 specifies the final position of axis 2.
- Y0 is the pulse output port of axis 1 and Y1 is the pulse output port of axis 2. See Sections 2-3

for other optional ports.

- The directional terminals are Y4 and Y5, it is ON for the forward pulse and OFF for the reverse pulse.
- Pulse frequency range: 1Hz ~ 100KHz; Acceleration and deceleration time: 0 ~ 65535ms.
- Location movement can be viewed in equivalent cumulative registers HSD2 and HSD6.
- Assuming HSD2 = 500, HSD6 = 1000, D0 = 5000, D10 = 2000, when M0 rises, execute LIN command and move to the target position at the default speed of 1000Hz:
  - (1) If the final position is absolute mode, the target position is (5000,2000);
  - (2) When the final position is in the relative mode, the target position is (5500,3000).
- When the LIN instruction is running, the pulse flag bit corresponding to its output port Y will be set on.
- The completion of the interpolation instruction can be judged by BLOCK executing flag bit. For example, the flag bit of BLOCK1 is SM300, when SM300 changes from ON to OFF, it means that BLOCK1 has finished executing.

### Mode 2: LIN line VM

#### 1. Instruction overview

Linear interpolation instruction, operate according to the set maximum synthetic speed. This instruction can only be used in BLOCK. See Section 2-2 for specific usage.

Linear interpolation [LIN]			
16-bit instruction	-	32-bit instruction	LIN
Execution condition	Rise/fall edge of coil	Suitable model	XDM, XDME, XLME, XDH
Firmware	V3.3 and above	Software	V3.3 and above

#### 2. Operand

Operand	Function	Type
S0	Axis 1 target position	Double words, 32-bit
S1	Axis 2 target position	Double words, 32-bit
S2	maximum synthetic speed of axis 1 and 2	Double words, 32-bit
D0	Pulse output port of axis 1	Bit
D1	Pulse output port of axis 2	Bit

## 3. Suitable soft component

Word	Operand	System								Constant	Module	
		D*	FD	TD*	CD*	DX	DY	DM*	DS*	K/H	ID	QD
S0		•	•	•	•							
S1		•	•	•	•							
S2		•	•	•	•							

Bit	Operand	System						
		X	Y	M*	S*	T*	C*	Dnm
D0			•					
D1			•					

\* Note: D denotes D HD; TD denotes TD HTD; CD denotes CD HCD HSCD HSD; DM denotes DM DHM; DS denotes DS DHS; M denotes M HM SM; S denotes S HS; T denotes T HT; C denotes C HC.

## 4. Parameter setting

Related parameters	Setting	Note
Final position	Free to specify register address	Must set
Relative/absolute	Relative: the above position as a reference; absolute: the origin as a reference	Must set
Max speed	Specify the maximum smooth running speed of the two-axis combination, and specify any address.	Must set
Pulse output port of axis 1	Arbitrary specify pulse output point	Must set
Pulse output port of axis 2	Arbitrary specify pulse output point	Must set
Direction port of axis 1	Arbitrarily specify idle output points, set in system parameters	Must set
Direction port of axis 2	Arbitrarily specify idle output points, set in system parameters	Must set
Pulse unit	The pulse number or equivalent are acceptable. Set in axis 1 system parameters	Must set
Default speed	set in axis 1 group 2 parameters	No need to set
Acceleration time	Set in axis 1 group 2 parameters	No need to set
Deceleration time	Set in axis 1 group 2 parameters	No need to set

### Function and action

《Instruction format》

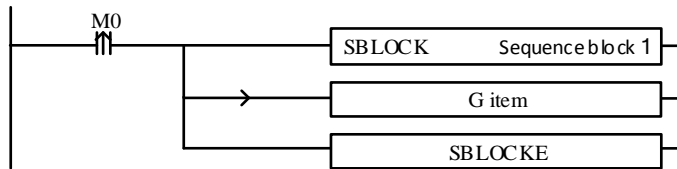

When the LIN instruction of linear interpolation (mode 2) is executed, the two axes will move rapidly from the current position to the target position at the set max synthetic speed. As shown in the following figure:

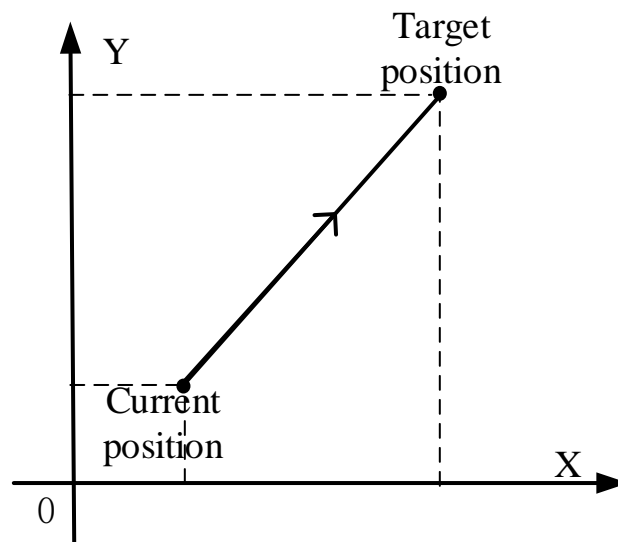

**LIN linear interpolation**

The parameter configuration is shown in the following figure:

Double-click G item and pop up the configuration panel. Set it as follows:

G Instruction

Skip      Comment: line VM

LIN line VM

	Params	Register	Absolute
	S0 final position	D0	Absolute
	S1 final position	D10	Absolute
	S2 max speed	D20	
▶	D0 axis 1	Y0	params
	D1 axis 2	Y1	params

OK      Cancel

Instruction configuration

PLC1 - Pulse Set

Config ▾ Delete    init axis    config guide

Param SFD906	Value
Y0 axis-Common-Parameters setting-Pulse direction logic	positive logic
Y0 axis-Common-Parameters setting-enable soft limit	disable
Y0 axis-Common-Parameters setting-mechanical back to...	negative
Y0 axis-Common-Parameters setting-Motor operating mo...	Position Mode
Y0 axis-Common-Parameters setting-Pulse unit	1um
Y0 axis-Common-Parameters setting-Interpolation coor...	Cross coordi...
Y0 axis-Common-pulse send mode	complete mode
Y0 axis-Common-Pulse num (1)	1
Y0 axis-Common-1um(revolve)	1
Y0 axis-Common-Pulse direction terminal	Y4
Y0 axis-Common-Delayed time of pulse direction (ms)	10

Read From PLC    Write To PLC    OK    Cancel

Axis Y0 system parameters (1)

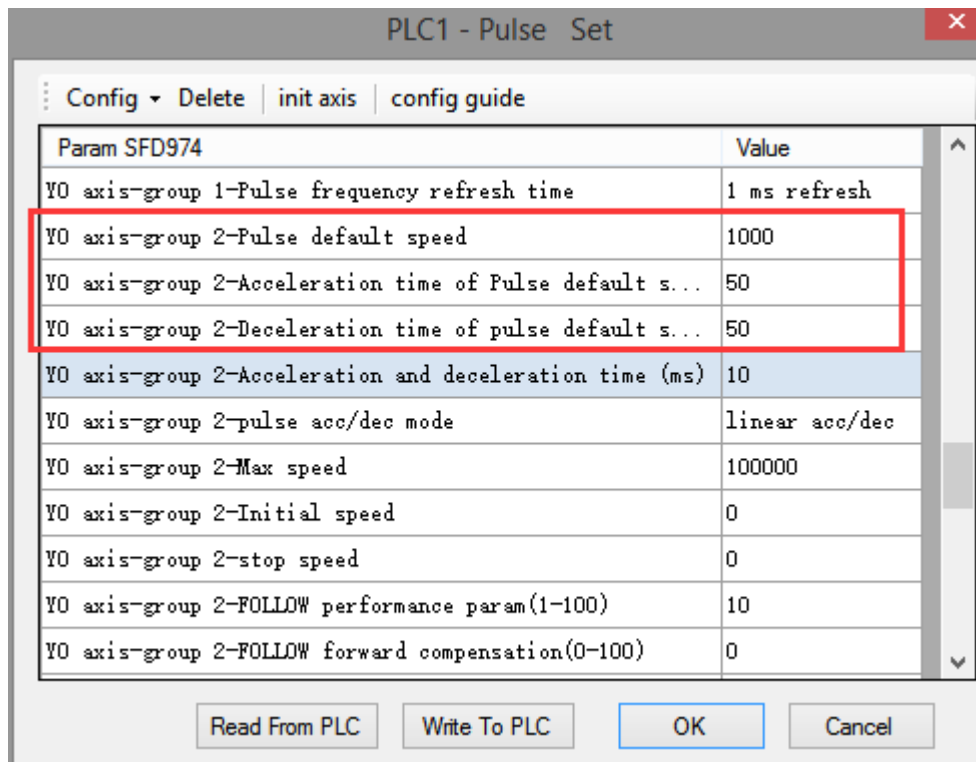

Axis Y0 system parameters (2)

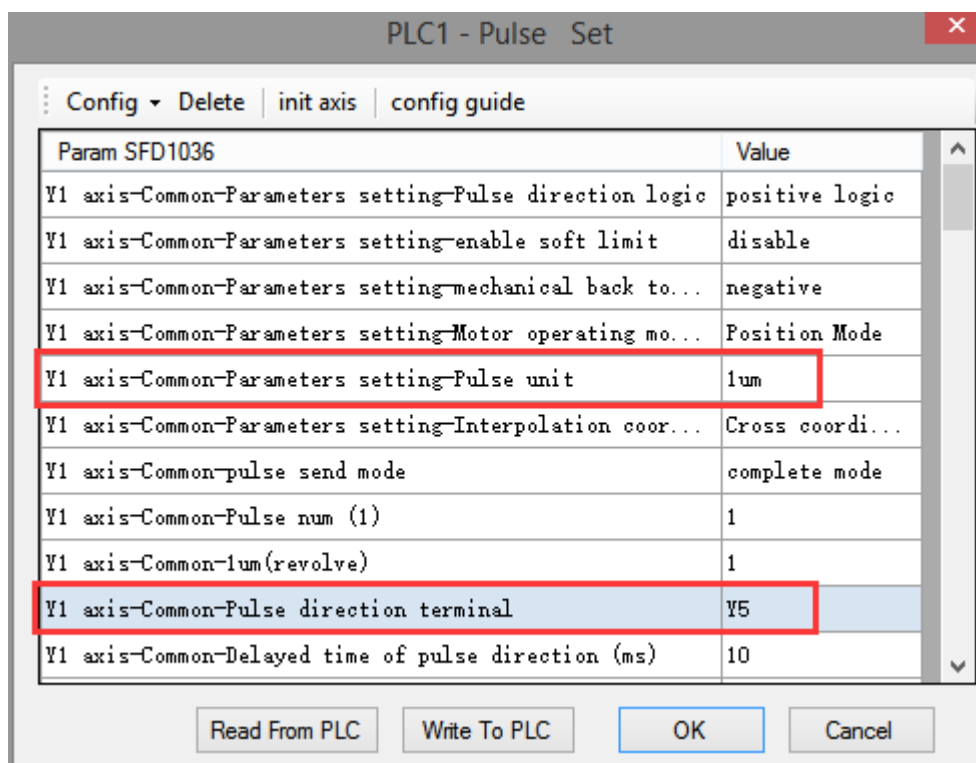

Axis Y1 system parameters

- As shown in the figure, D0 specifies the final position of axis 1 and D10 specifies the final position of axis 2, D20 specifies the max speed.
- Y0 is the pulse output port of axis 1 and Y1 is the pulse output port of axis 2. See Sections 2-3

for other optional ports.

- The directional terminals are Y4 and Y5, it is ON for the forward pulse and OFF for the reverse pulse.
- Pulse frequency range: 1Hz ~ 100KHz; Acceleration and deceleration time: 0 ~ 65535ms.
- Location movement can be viewed in equivalent cumulative registers HSD2 and HSD6.
- Assuming HSD2 = 500, HSD6 = 1000, D0 = 5000, D10 = 2000, D20 = 2000, when M0 rises, execute LIN command and move to the target position at the speed of 2000Hz:
  - (1) If the final position is absolute mode, the target position is (5000,2000);
  - (2) When the final position is in the relative mode, the target position is (5500,3000).
- When the LIN instruction is running, the pulse flag bit corresponding to its output port Y will be set on.
- The completion of the interpolation instruction can be judged by BLOCK executing flag bit. For example, the flag bit of BLOCK1 is SM300, when SM300 changes from ON to OFF, it means that BLOCK1 has finished executing.

### Mode 3: LIN line VBEM

#### 1. Instruction overview

Linear interpolation instruction, operate according to the set maximum synthetic speed, start speed and stop speed. This instruction can only be used in BLOCK. See Section 2-2 for specific usage.

Linear interpolation [LIN]			
16-bit instruction	-	32-bit instruction	LIN
Execution condition	Rise/fall edge of coil	Suitable model	XDM, XDME, XLME, XDH
Firmware	V3.3 and above	Software	V3.3 and above

#### 2. Operand

Operand	Function	Type
S0	Axis 1 target position	Double words, 32-bit
S1	Axis 2 target position	Double words, 32-bit
S2	Start speed of axis 1 and 2	Double words, 32-bit
S3	Stop speed of axis 1 and 2	Double words, 32-bit
S4	maximum synthetic speed of axis 1 and 2	Double words, 32-bit
D0	Pulse output port of axis 1	Bit
D1	Pulse output port of axis 2	Bit

## 3. Suitable soft component

Word	Operand	System								Constant	Module	
		D*	FD	TD*	CD*	DX	DY	DM*	DS*	K/H	ID	QD
S0		•	•	•	•							
S1		•	•	•	•							
S2		•	•	•	•							
S3		•	•	•	•							
S4		•	•	•	•							

Bit	Operand	System						
		X	Y	M*	S*	T*	C*	Dnm
D0			•					
D1			•					

\* Note: D denotes D HD; TD denotes TD HTD; CD denotes CD HCD HSCD HSD; DM denotes DM DHM; DS denotes DS DHS; M denotes M HM SM; S denotes S HS; T denotes T HT; C denotes C HC.

## 4. Parameter setting

Related parameters	Setting	Note
Final position	Free to specify register address	Must set
Relative/absolute	Relative: the above position as a reference; absolute: the origin as a reference	Must set
Start speed	Start speed at the starting point of the two axes	Must set
Stop speed	Stop speed at the end point of the two axes	Must set
Max speed	Specify the maximum smooth running speed of the two-axis combination, and specify any address.	Must set
Pulse output port of axis 1	Arbitrary specify pulse output point	Must set
Pulse output port of axis 2	Arbitrary specify pulse output point	Must set
Direction port of axis 1	Arbitrarily specify idle output points, set in system parameters	Must set
Direction port of axis 2	Arbitrarily specify idle output points, set in system parameters	Must set
Pulse unit	The pulse number or equivalent are acceptable. Set in axis 1 system parameters	Must set
Default speed	set in axis 1 group 2 parameters	No need to set
Acceleration time	Set in axis 1 group 2 parameters	No need to set
Deceleration time	Set in axis 1 group 2 parameters	No need to set



### Function and action

«Instruction format»

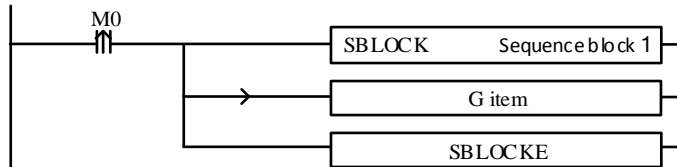

When the LIN instruction of linear interpolation (mode 3) is executed, the two axes will move rapidly from the current position to the target position at the set max synthetic speed, start speed and stop speed. As shown in the following figure:

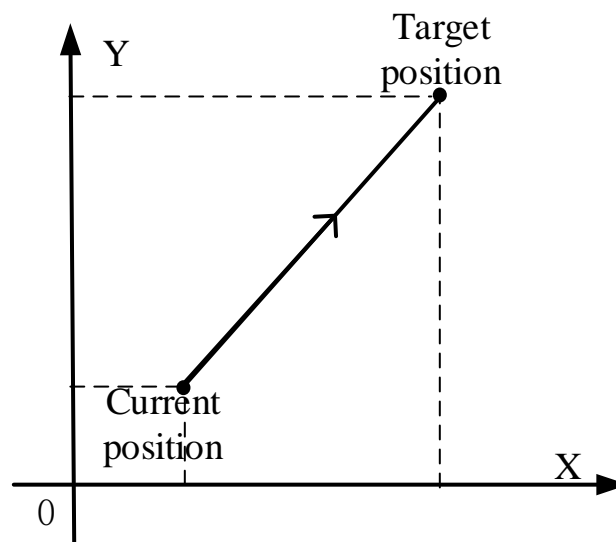

**LIN linear interpolation**

The parameter configuration is shown in the following figure:

Double-click G item and pop up the configuration panel. Set it as follows:

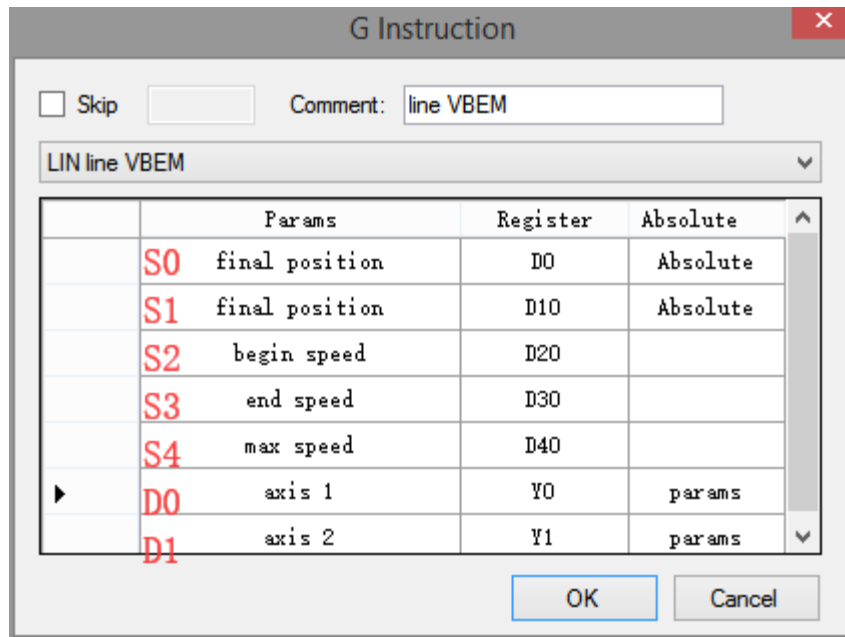

Instruction configuration

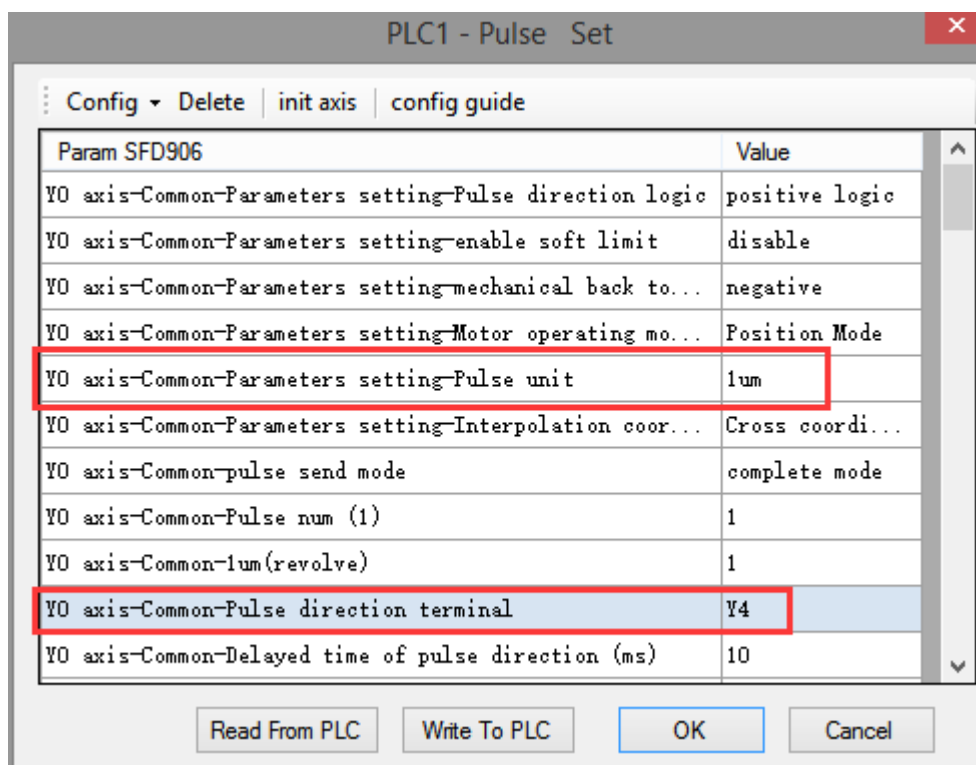

Axis Y0 system parameters (1)

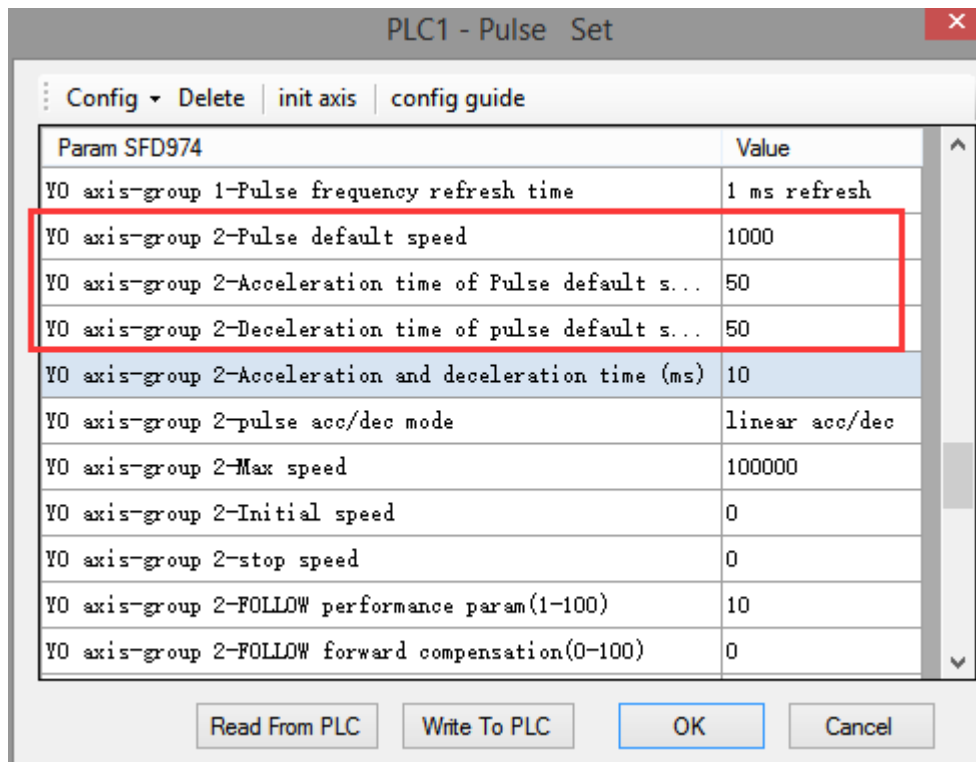

Axis Y0 system parameters (2)

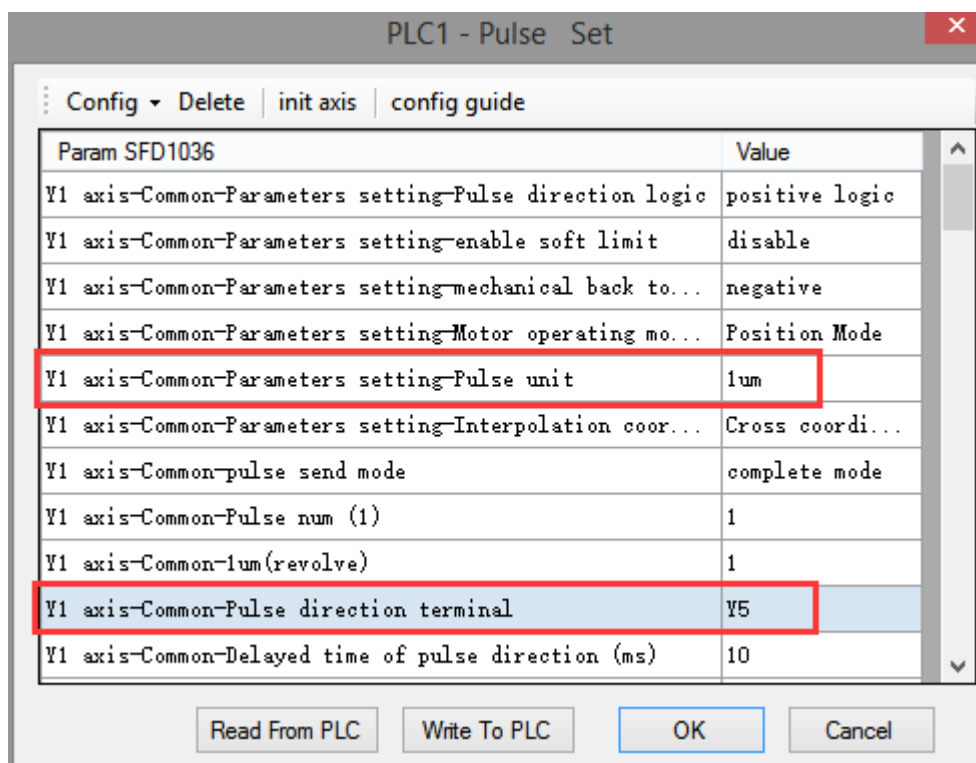

Axis Y1 system parameters

- As shown in the figure, D0 specifies the final position of axis 1 and D10 specifies the final position of axis 2, D20 specifies the start speed, D30 specifies the stop speed, D40 specifies the max speed.

- Y0 is the pulse output port of axis 1 and Y1 is the pulse output port of axis 2. See Sections 2-3 for other optional ports.
  - The directional terminals are Y4 and Y5, it is ON for the forward pulse and OFF for the reverse pulse.
  - Pulse frequency range: 1Hz ~ 100KHz; Acceleration and deceleration time: 0 ~ 65535ms.
  - Location movement can be viewed in equivalent cumulative registers HSD2 and HSD6.
    - Assuming HSD2 = 500, HSD6 = 1000, D0 = 5000, D10 = 2000, D20 = 100, D30 = 50, D40 = 2000, when M0 rises, execute LIN command, accelerate from the starting point at 100Hz to 2000 Hz and stop at 50Hz after moving to the target position.
- (1) If the final position is absolute mode, the target position is (5000,2000);  
 (2) When the final position is in the relative mode, the target position is (5500,3000).
- When the LIN instruction is running, the pulse flag bit corresponding to its output port Y will be set on.
  - The completion of the interpolation instruction can be judged by BLOCK executing flag bit. For example, the flag bit of BLOCK1 is SM300, when SM300 changes from ON to OFF, it means that BLOCK1 has finished executing.

Note: In this mode, the start speed (S2), the stop speed (S3) and the max speed (S4) are all expressed as the two-axis synthesis speed, as shown in the following figure:

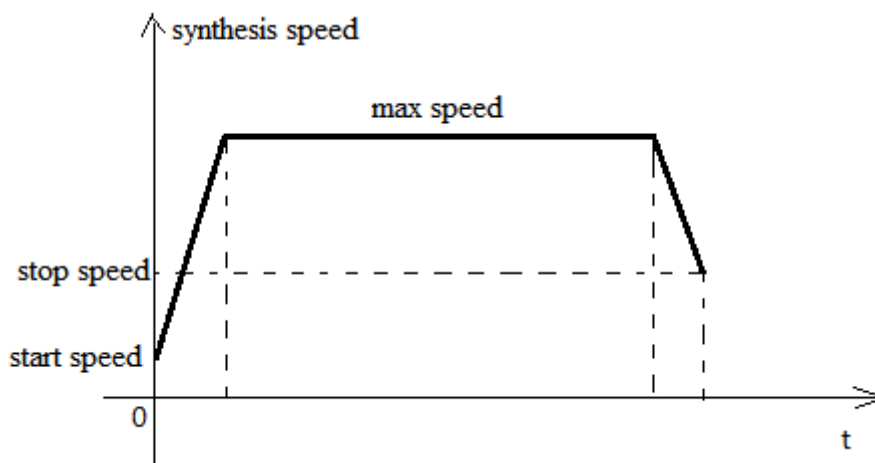

When there are multiple continuous linear/arc interpolation instructions and the speed between them needs to be constant and jump directly, the stop speed and maximum speed of the previous linear/arc interpolation can be set the same as the start speed and maximum speed of the next segment.

When the third mode is used, the initial and stop speed in the pulse parameter configuration tables of axis 1 and axis 2 are only effective for calculating the slope of pulse acceleration and deceleration.

### 2-4-4. Clockwise arc [CW]

CW interpolation mainly determines the arc through the current position of the arc, the target position and the coordinates of the center of the circle, as shown in the following figure:

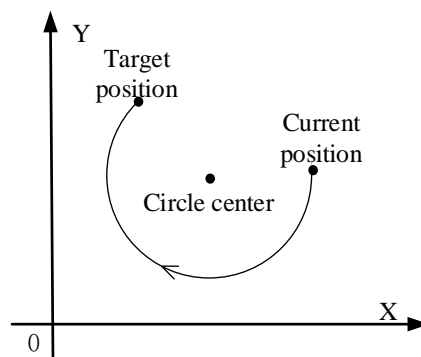

From the above figure, we can see that when we need to draw a whole circle, we only need to set the target position to the current position. CW has three modes. The usage of CW is described below.

#### Mode 1: CW clockwise

##### 1. Instruction overview

Clockwise arc interpolation instruction, operate according to the set default speed. This instruction can only be used in BLOCK. See Section 2-2 for specific usage.

Clockwise arc interpolation [CW]			
16-bit instruction	-	32-bit instruction	CW
Execution condition	Rise/fall edge of coil	Suitable model	XDM, XDME, XLME, XDH
Firmware	V3.3 and above	Software	V3.3 and above

##### 2. Operand

Operand	Function	Type
S0	Axis 1 target position	Double words, 32-bit
S1	Axis 2 target position	Double words, 32-bit
S2	Specify the center position of axis 1 (always relative to the starting coordinates)	Double words, 32-bit
S3	Specify the center position of axis 2 (always relative to the starting coordinates)	Double words, 32-bit
D0	Pulse output port of axis 1	Bit
D1	Pulse output port of axis 2	Bit

## 3. Suitable soft component

Word	Operand	System								Constant	Module	
		D*	FD	TD*	CD*	DX	DY	DM*	DS*	K/H	ID	QD
S0		•	•	•	•							
S1		•	•	•	•							
S2		•	•	•	•							
S3		•	•	•	•							

Bit	Operand	System						
		X	Y	M*	S*	T*	C*	Dnm
D0			•					
D1			•					

\* Note: D denotes D HD; TD denotes TD HTD; CD denotes CD HCD HSCD HSD; DM denotes DM DHM; DS denotes DS DHS; M denotes M HM SM; S denotes S HS; T denotes T HT; C denotes C HC.

## 4. Parameter setting

Related parameters	Setting	Note
Final position	Determine the end point position according to relative/absolute mode	Must set
Relative/absolute	Relative: the above position as a reference; absolute: the origin as a reference	Must set
Circle center position	The position of the center is determined by the position of the starting point and the end point	Must set
Pulse output port of axis 1	Arbitrary specify pulse output point	Must set
Pulse output port of axis 2	Arbitrary specify pulse output point	Must set
Direction port of axis 1	Arbitrarily specify idle output points, set in system parameters	Must set
Direction port of axis 2	Arbitrarily specify idle output points, set in system parameters	Must set
Pulse unit	The pulse number or equivalent are acceptable. Set in axis 1 system parameters	Must set
Default speed	set in axis 1 group 2 parameters	Must set
Acceleration time	Set in axis 1 group 2 parameters	No need to set
Deceleration time	Set in axis 1 group 2 parameters	No need to set

## Function and action

《Instruction format》

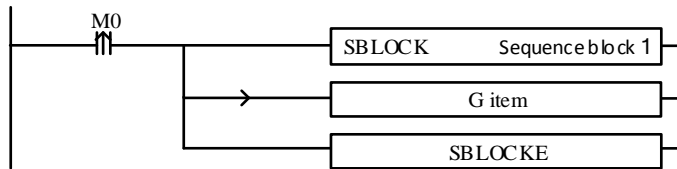

When the CW instruction of arc interpolation (mode 1) is executed, the two axes will run at the highest synthesis speed. As shown in the following figure:

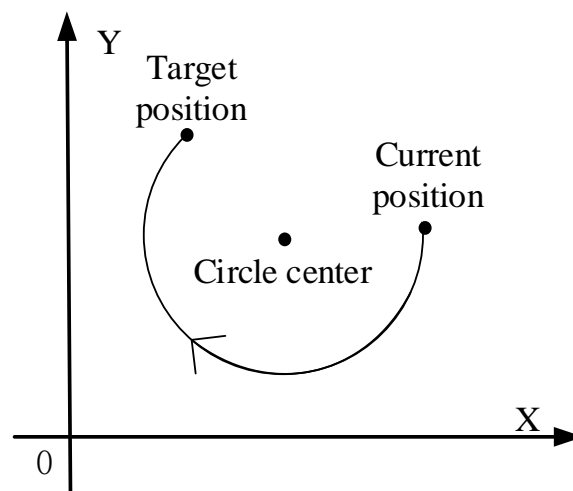

**CW clockwise arc interpolation**

The parameter configuration is shown in the following figure:  
Double-click G item and pop up the configuration panel. Set it as follows:

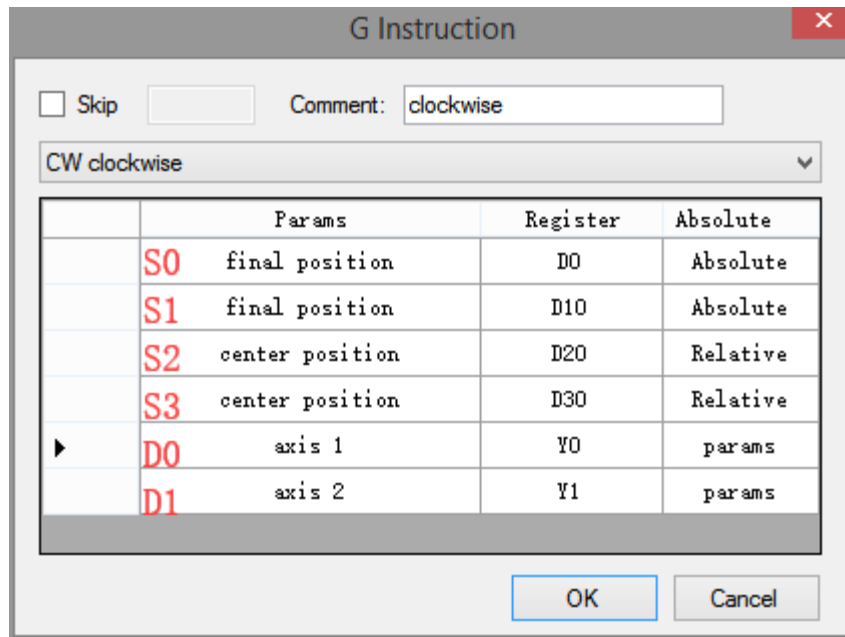

Instruction configuration

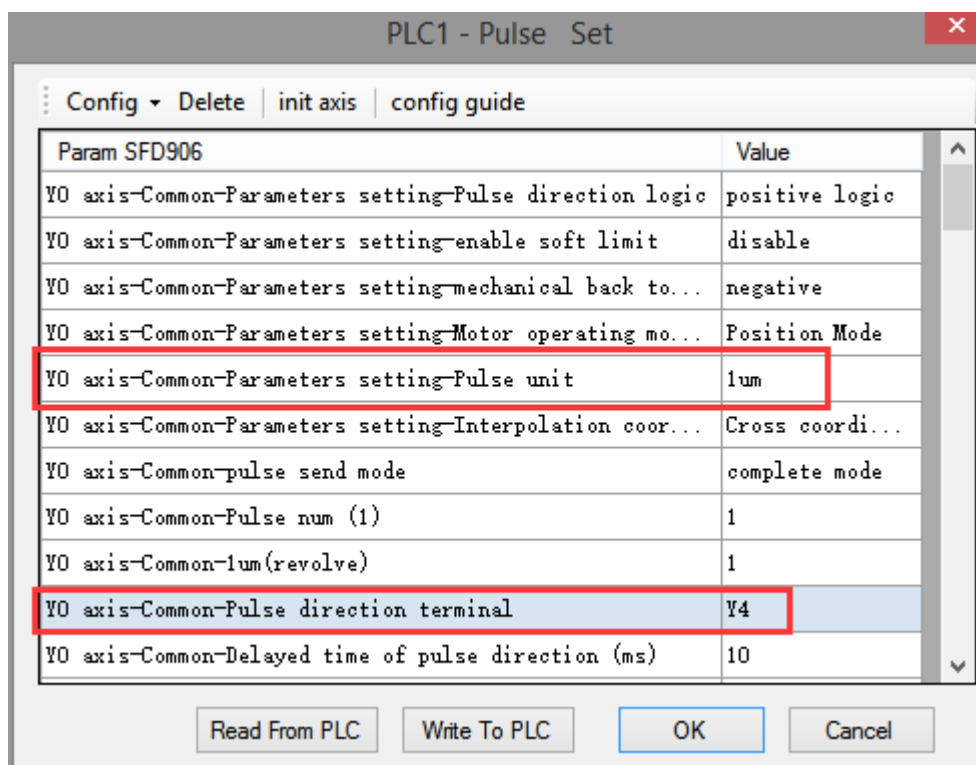

Axis Y0 system parameters (1)



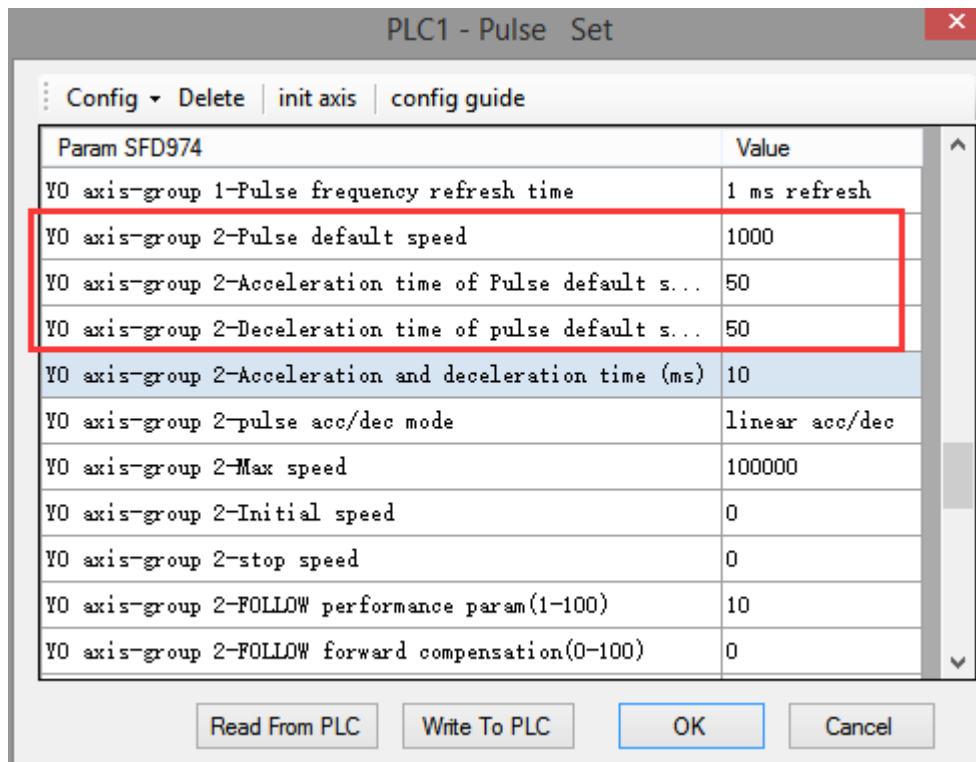

Axis Y0 system parameters (2)

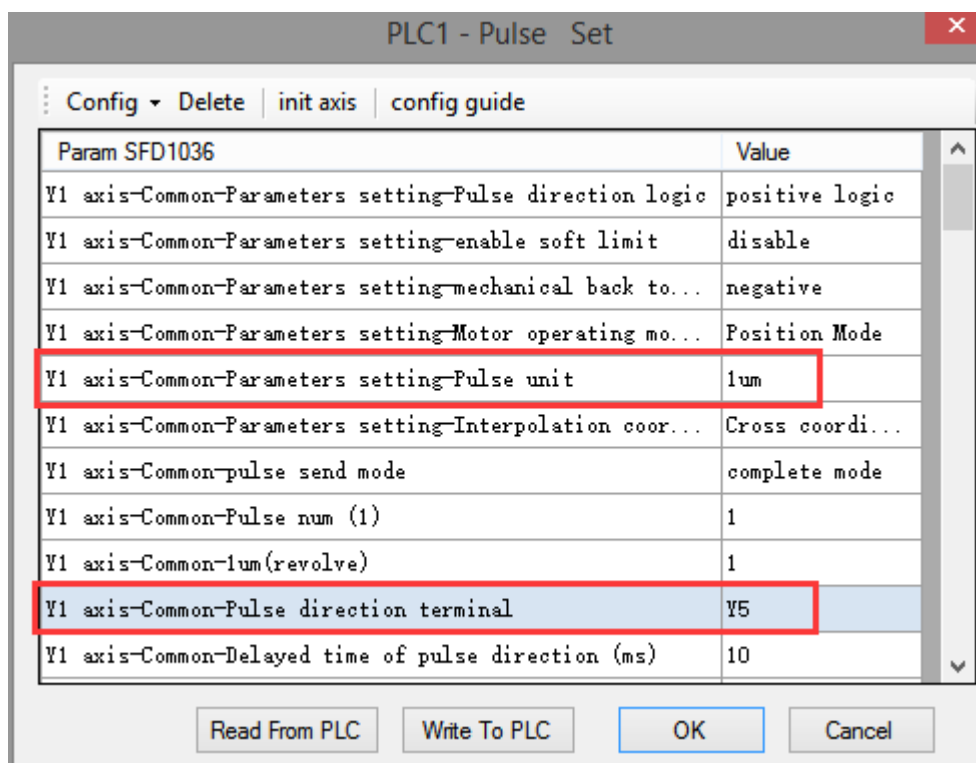

Axis Y1 system parameters

- As shown in the figure, D0 specifies the final position of axis 1 and D10 specifies the final position of axis 2, D20 specifies the circle center of axis 1, D30 specifies the circle center of axis 2.

- Y0 is the pulse output port of axis 1 and Y1 is the pulse output port of axis 2. See Sections 2-3 for other optional ports.
  - The directional terminals are Y4 and Y5, it is ON for the forward pulse and OFF for the reverse pulse.
  - Pulse frequency range: 1Hz ~ 100KHz; Acceleration and deceleration time: 0 ~ 65535ms.
  - Location movement can be viewed in equivalent cumulative registers HSD2 and HSD6.
  - Assuming HSD2 = 1000, HSD6 = 1000, D0 = 5000, D10 = 2000, when M0 rises, execute CW command, move from the starting position (1000, 1000) to the target position at the default speed of 1000Hz.
- (1) When the end point is in absolute mode, the target position is (5000,2000), the center position is (3000,1500), and D20 = 2000, D30 = 500.
- (2) When the end point is in the relative mode, the target position is (6000,3000), the center position is (3500,2000), and D20 = 2500, D30 = 1000.
- When the CW instruction is running, the pulse flag bit corresponding to its output port Y will be set on.
  - The completion of the interpolation instruction can be judged by BLOCK executing flag bit. For example, the flag bit of BLOCK1 is SM300, when SM300 changes from ON to OFF, it means that BLOCK1 has finished executing.

### Mode 2: CW clockwise VM

#### 1. Instruction overview

Clockwise arc interpolation instruction, operate according to the set maximum synthetic speed. This instruction can only be used in BLOCK. See Section 2-2 for specific usage.

Clockwise arc interpolation [CW]			
16-bit instruction	-	32-bit instruction	CW
Execution condition	Rise/fall edge of coil	Suitable model	XDM, XDME, XLME, XDH
Firmware	V3.3 and above	Software	V3.3 and above

#### 2. Operand

Operand	Function	Type
S0	Axis 1 target position	Double words, 32-bit
S1	Axis 2 target position	Double words, 32-bit
S2	Specify the center position of axis 1 (always relative to the starting coordinates)	Double words, 32-bit
S3	Specify the center position of axis 2 (always relative to the starting coordinates)	Double words, 32-bit
S4	Max speed of the two axes	Double words, 32-bit
D0	Pulse output port of axis 1	Bit
D1	Pulse output port of axis 2	Bit

## 3. Suitable soft component

Word	Operand	System								Constant	Module	
		D*	FD	TD*	CD*	DX	DY	DM*	DS*	K/H	ID	QD
S0		•	•	•	•							
S1		•	•	•	•							
S2		•	•	•	•							
S3		•	•	•	•							
S4		•	•	•	•							

Bit	Operand	System						
		X	Y	M*	S*	T*	C*	Dnm
D0			•					
D1			•					

\* Note: D denotes D HD; TD denotes TD HTD; CD denotes CD HCD HSCD HSD; DM denotes DM DHM; DS denotes DS DHS; M denotes M HM SM; S denotes S HS; T denotes T HT; C denotes C HC.

## 4. Parameter setting

Related parameters	Setting	Note
Final position	Determine the end point position according to relative/absolute mode	Must set
Relative/absolute	Relative: the above position as a reference; absolute: the origin as a reference	Must set
Circle center position	The position of the center is determined by the position of the starting point and the end point	Must set
Max speed	Specify maximum smooth running speed of two axes	Must set
Pulse output port of axis 1	Arbitrarily specify pulse output point	Must set
Pulse output port of axis 2	Arbitrarily specify pulse output point	Must set
Direction port of axis 1	Arbitrarily specify idle output points, set in system parameters	Must set
Direction port of axis 2	Arbitrarily specify idle output points, set in system parameters	Must set
Pulse unit	The pulse number or equivalent are acceptable. Set in axis 1 system parameters	Must set
Default speed	set in axis 1 group 2 parameters	No need to set
Acceleration time	Set in axis 1 group 2 parameters	No need to set
Deceleration time	Set in axis 1 group 2 parameters	No need to set

## Function and action

《Instruction format》

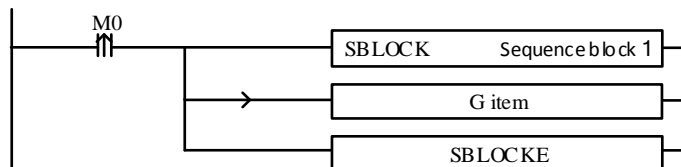

When the CW instruction of arc interpolation (mode 2) is executed, the two axes will run at the set max synthesis speed. As shown in the following figure:

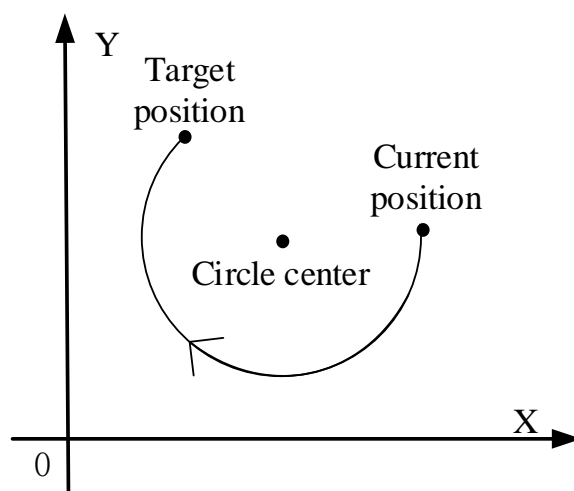

**CW clockwise arc interpolation**

The parameter configuration is shown in the following figure:

Double-click G item and pop up the configuration panel. Set it as follows:

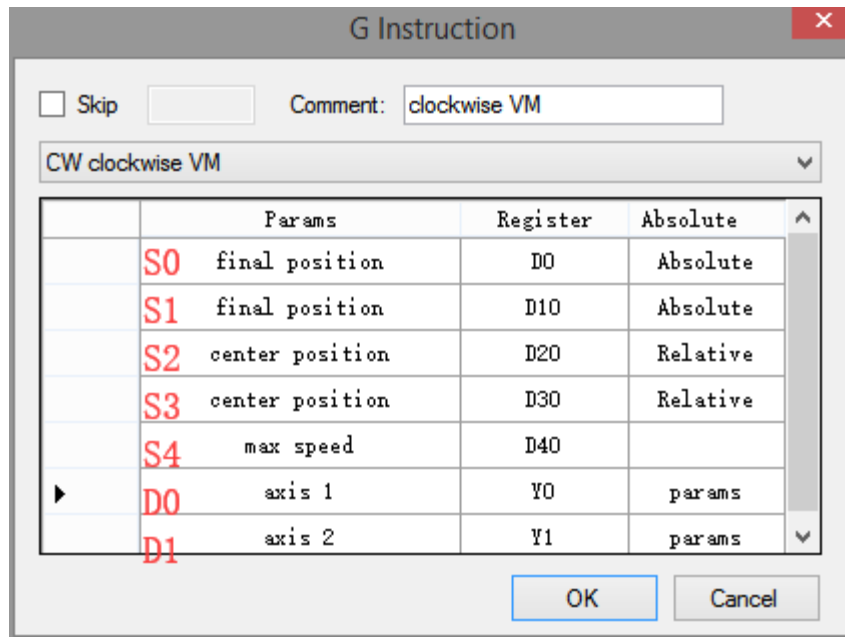

Instruction configuration

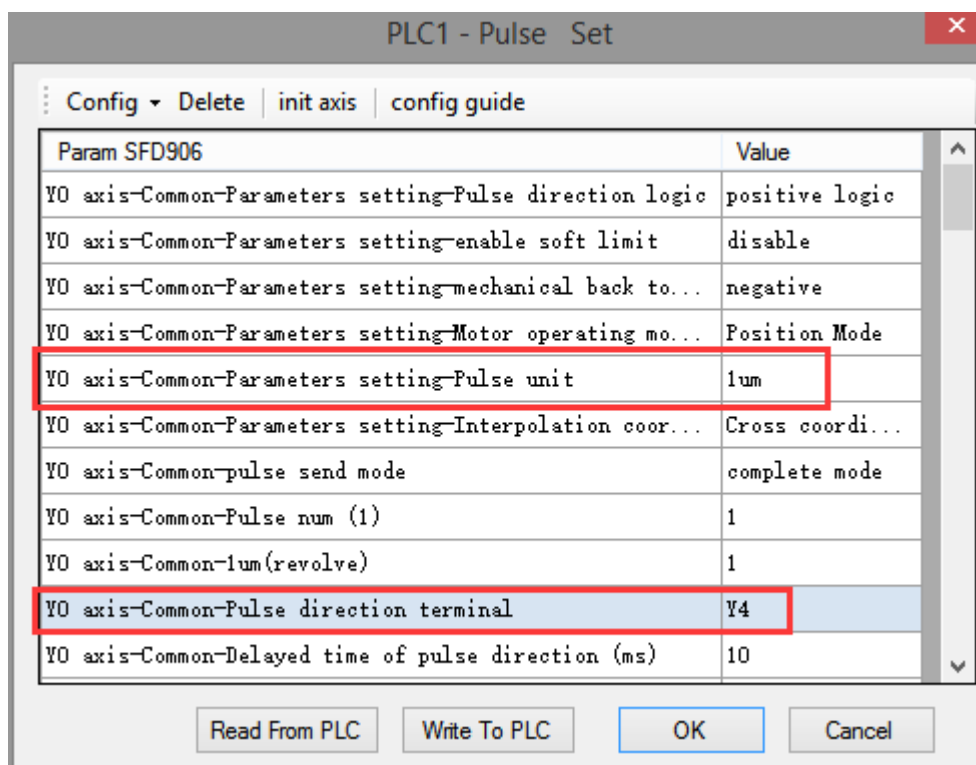

Axis Y0 system parameters (1)

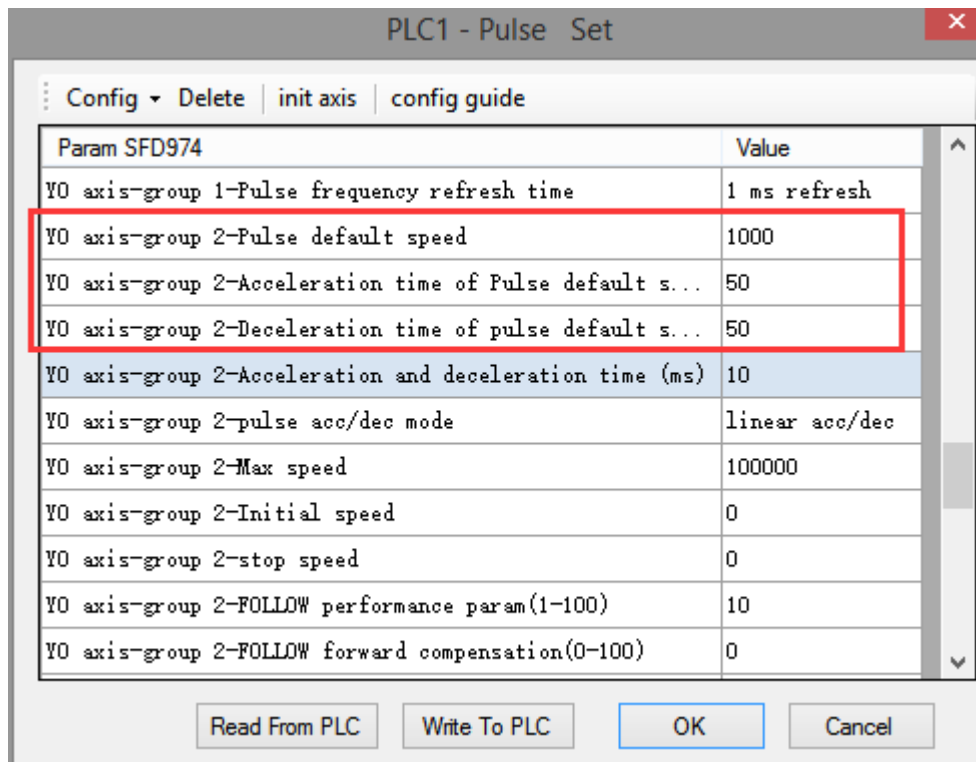

Axis Y0 system parameters (2)

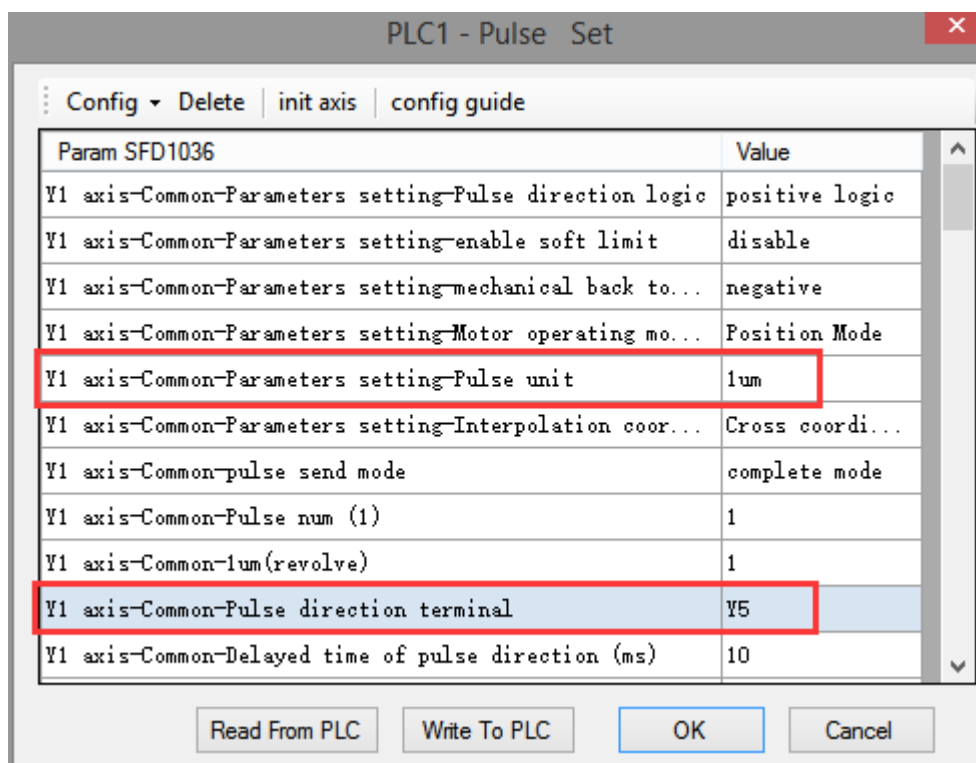

Axis Y1 system parameters

- As shown in the figure, D0 specifies the final position of axis 1 and D10 specifies the final position of axis 2, D20 specifies the circle center of axis 1, D30 specifies the circle center of axis 2, D40 specifies the max speed.

- Y0 is the pulse output port of axis 1 and Y1 is the pulse output port of axis 2. See Sections 2-3 for other optional ports.
  - The directional terminals are Y4 and Y5, it is ON for the forward pulse and OFF for the reverse pulse.
  - Pulse frequency range: 1Hz ~ 100KHz; Acceleration and deceleration time: 0 ~ 65535ms.
  - Location movement can be viewed in equivalent cumulative registers HSD2 and HSD6.
  - Assuming HSD2 = 1000, HSD6 = 1000, D0 = 5000, D10 = 2000, D40 = 500Hz, when M0 rises, execute CW command, move from the starting position (1000, 1000) to the target position at the max speed of 500Hz.
- (1) When the end point is in absolute mode, the target position is (5000,2000), the center position is (3000,1500), and D20 = 2000, D30 = 500.
- (2) When the end point is in the relative mode, the target position is (6000,3000), the center position is (3500,2000), and D20 = 2500, D30 = 1000.
- When the CW instruction is running, the pulse flag bit corresponding to its output port Y will be set on.
  - The completion of the interpolation instruction can be judged by BLOCK executing flag bit. For example, the flag bit of BLOCK1 is SM300, when SM300 changes from ON to OFF, it means that BLOCK1 has finished executing.

### Mode 3: CW clockwise VBEM

#### 1. Instruction overview

Clockwise arc interpolation instruction, operate according to the set maximum synthetic speed, start speed and stop speed. This instruction can only be used in BLOCK. See Section 2-2 for specific usage.

Clockwise arc interpolation [CW]			
16-bit instruction	-	32-bit instruction	CW
Execution condition	Rise/fall edge of coil	Suitable model	XDM, XDME, XLME, XDH
Firmware	V3.3 and above	Software	V3.3 and above

#### 2. Operand

Operand	Function	Type
S0	Axis 1 target position	Double words, 32-bit
S1	Axis 2 target position	Double words, 32-bit
S2	Specify the center position of axis 1 (always relative to the starting coordinates)	Double words, 32-bit
S3	Specify the center position of axis 2 (always relative to the starting coordinates)	Double words, 32-bit
S4	Specify the starting speed at the starting point of the two axes	Double words, 32-bit

S5	Specify the stop speed at the end point of the two axes	Double words, 32-bit
S6	Max speed of the two axes	Double words, 32-bit
D0	Pulse output port of axis 1	Bit
D1	Pulse output port of axis 2	Bit

## 3. Suitable soft component

Word	Operand	System								Constant	Module	
		D*	FD	TD*	CD*	DX	DY	DM*	DS*	K/H	ID	QD
	S0~S6	•	•	•	•							
Bit	Operand	System										
		X	Y	M*	S*	T*	C*	Dnm				
	D0		•									
	D1		•									

\* Note: D denotes D HD; TD denotes TD HTD; CD denotes CD HCD HSCD HSD; DM denotes DM DHM; DS denotes DS DHS; M denotes M HM SM; S denotes S HS; T denotes T HT; C denotes C HC.

## 4. Parameter setting

Related parameters	Setting	Note
Final position	Determine the end point position according to relative/absolute mode	Must set
Relative/absolute	Relative: the above position as a reference; absolute: the origin as a reference	Must set
Circle center position	The position of the center is determined by the position of the starting point and the end point	Must set
Max speed	Specify maximum smooth running speed of two axes	Must set
Start speed	The start speed from the starting point	Must set
Stop speed	The stop speed at the end point	Must set
Pulse output port of axis 1	Arbitrary specify pulse output point	Must set
Pulse output port of axis 2	Arbitrary specify pulse output point	Must set
Direction port of axis 1	Arbitrarily specify idle output points, set in system parameters	Must set
Direction port of axis 2	Arbitrarily specify idle output points, set in system parameters	Must set
Pulse unit	The pulse number or equivalent are acceptable. Set in axis 1 system parameters	Must set
Default speed	set in axis 1 group 2 parameters	No need to set
Acceleration time	Set in axis 1 group 2 parameters	No need to set



Deceleration time	Set in axis 1 group 2 parameters	No need to set
-------------------	----------------------------------	----------------

### Function and action

«Instruction format»

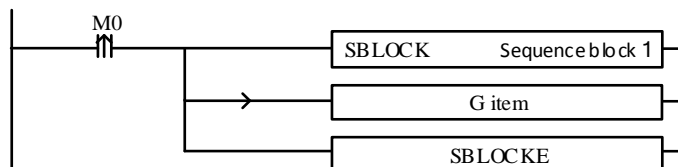

When the CW instruction of arc interpolation (mode 3) is executed, the two axes will run at the set max synthesis speed, start speed and stop speed. As shown in the following figure:

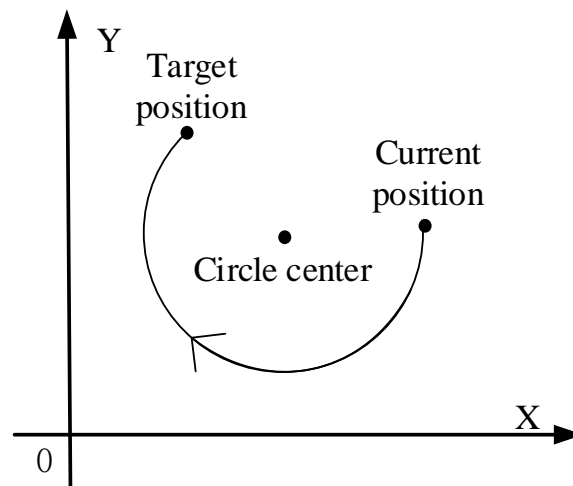

**CW clockwise arc interpolation**

The parameter configuration is shown in the following figure:

Double-click G item and pop up the configuration panel. Set it as follows:

G Instruction ✕

Skip  Comment:

CW clockwise VBEM

	Params	Register	Absolute
	<b>S0</b> final position	D0	Absolute
	<b>S1</b> final position	D10	Absolute
	<b>S2</b> center position	D20	Relative
	<b>S3</b> center position	D30	Relative
	<b>S4</b> begin speed	D40	
	<b>S5</b> end speed	D50	
	<b>S6</b> max speed	D60	

OK Cancel

G Instruction ✕

Skip  Comment:

CW clockwise VBEM

	Params	Register	Absolute
	center position	D30	Relative
	begin speed	D40	
	end speed	D50	
	max speed	D60	
▶	<b>D0</b> axis 1	Y0	params
	<b>D1</b> axis 2	Y1	params

OK Cancel

Instruction configuration

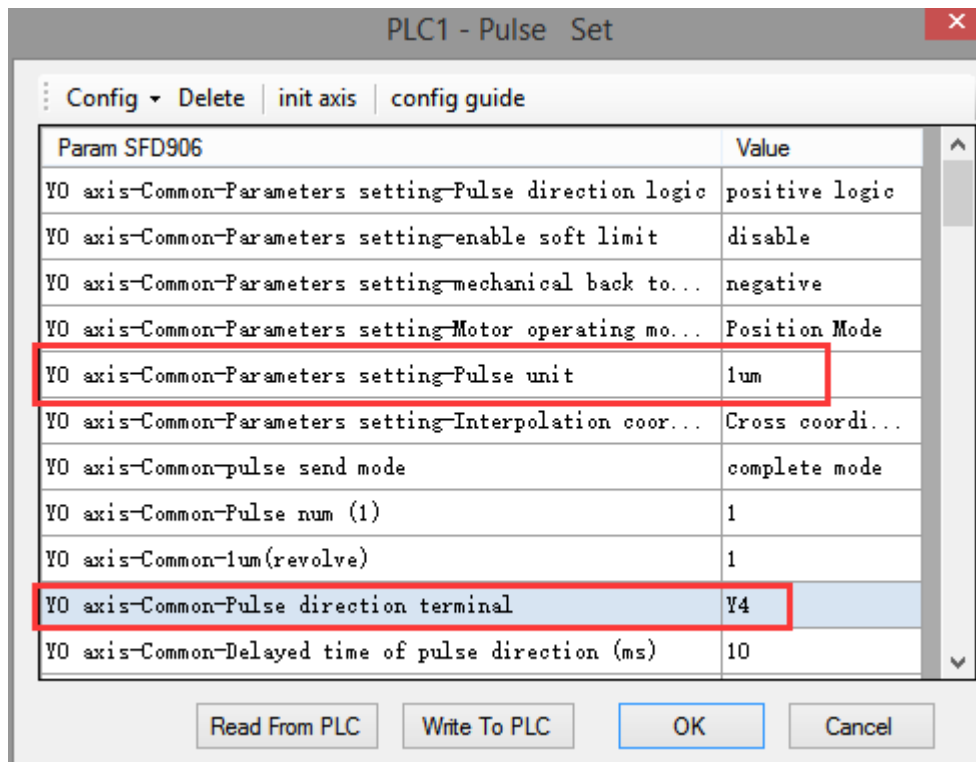

Axis Y0 system parameters (1)

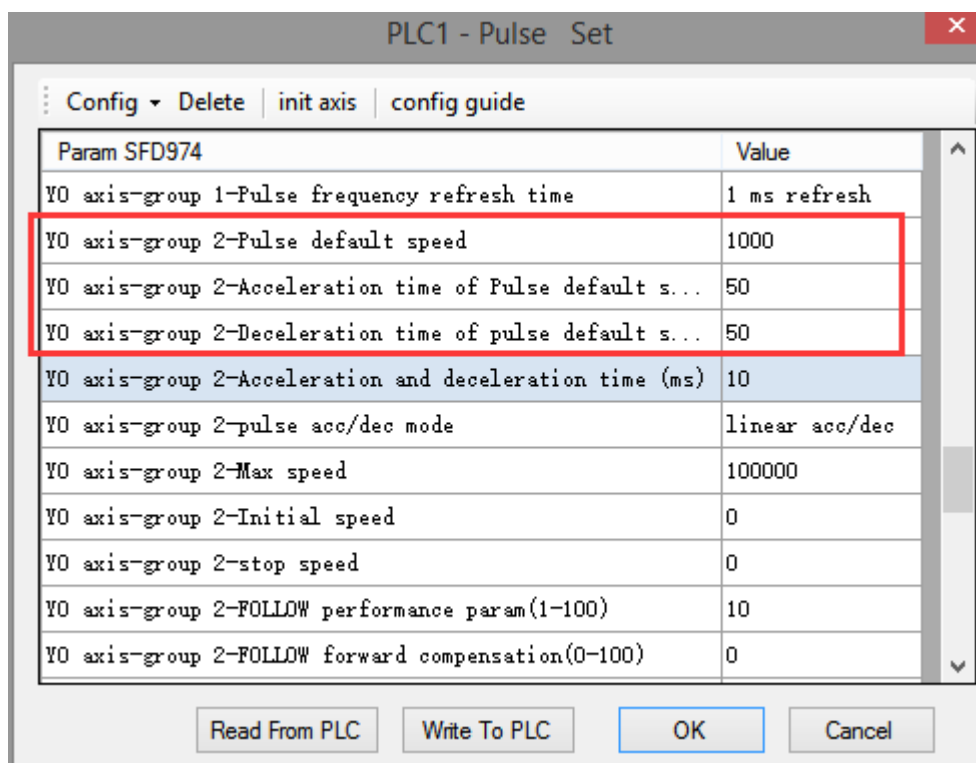

Axis Y0 system parameters (2)

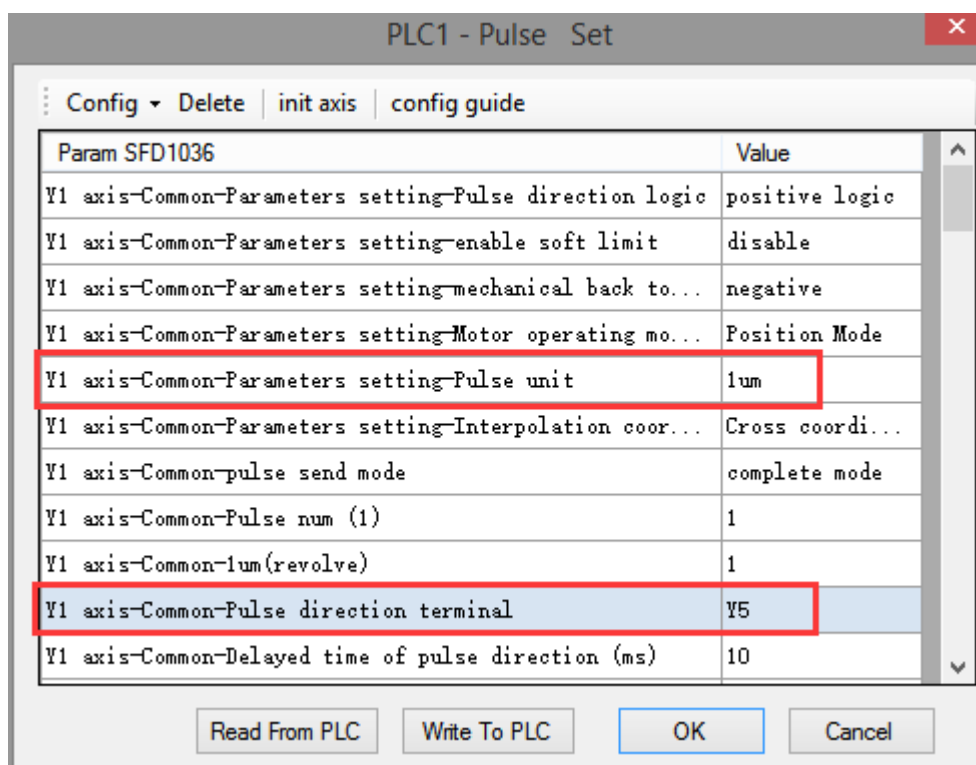

Axis Y1 system parameters

- As shown in the figure, D0 specifies the final position of axis 1 and D10 specifies the final position of axis 2, D20 specifies the circle center of axis 1, D30 specifies the circle center of axis 2, D40 specifies the start speed, D50 specifies the stop speed, D60 specifies the max speed.
  - Y0 is the pulse output port of axis 1 and Y1 is the pulse output port of axis 2. See Sections 2-3 for other optional ports.
  - The directional terminals are Y4 and Y5, it is ON for the forward pulse and OFF for the reverse pulse.
  - Pulse frequency range: 1Hz ~ 100KHz; Acceleration and deceleration time: 0 ~ 65535ms.
  - Location movement can be viewed in equivalent cumulative registers HSD2 and HSD6.
  - Assuming HSD2 = 1000, HSD6 = 1000, D0 = 5000, D10 = 2000, D40 = 50Hz, D50 = 20, D60 = 2000, when M0 rises, execute CW command, accelerate from the starting position (1000,1000) at speed 50Hz to the maximum speed (2000Hz), and stop at the end speed of 20Hz when moving to the target position.
- (1) When the end point is in absolute mode, the target position is (5000,2000), the center position is (3000,1500), and D20 = 2000, D30 = 500.
- (2) When the end point is in the relative mode, the target position is (6000,3000), the center position is (3500,2000), and D20 = 2500, D30 = 1000.
- When the CW instruction is running, the pulse flag bit corresponding to its output port Y will be set on.
  - The completion of the interpolation instruction can be judged by BLOCK executing flag bit. For example, the flag bit of BLOCK1 is SM300, when SM300 changes from ON to OFF, it means that BLOCK1 has finished executing.

Note: In this mode, the starting speed (S4), the ending speed (S5) and the maximum speed (S6) are all expressed as the two-axis synthesis speed, as shown in the following figure:

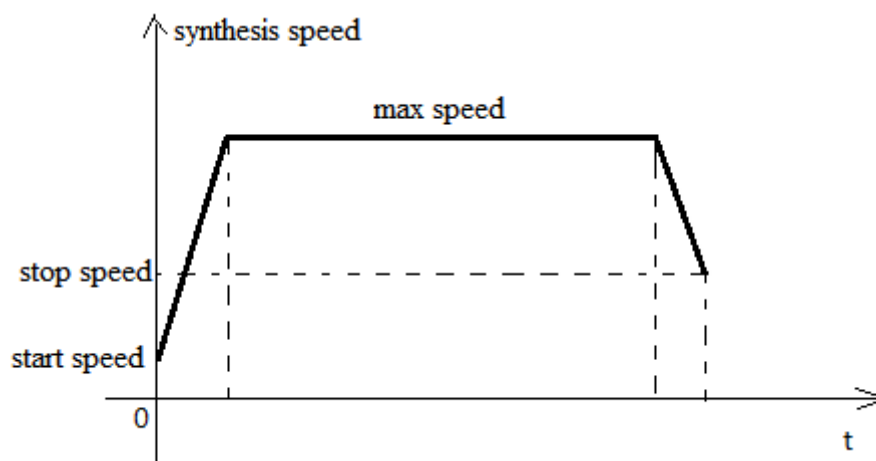

When there are multiple continuous linear/arc interpolation instructions and the speed between them needs to be constant and jump directly, the termination speed and maximum speed of the previous linear/arc interpolation can be set the same as the starting speed and maximum speed of the next segment.

When mode 3 is used, the starting and ending speed in the pulse parameter configuration tables of axis 1 and axis 2 are only effective for calculating the slope of pulse acceleration and deceleration.

#### 2-4-5. Anticlockwise arc [CCW]

Anticlockwise arc interpolation CCW determines a section of arc mainly through the current position of arc, the target position and the counterclockwise coordinates of the center of the circle, as shown in the following figure:

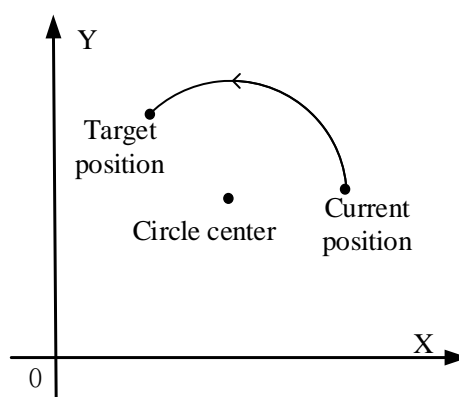

With the above image, when you need to draw an entire circle, just set the target position to the current position. There are three modes of anticlockwise arc interpolation CCW, the usage of which is described below.

**Mode 1: CCW anticlockwise arc**

## 1. Instruction overview

Anticlockwise arc interpolation instruction, operate according to the set default speed. This instruction can only be used in BLOCK. See Section 2-2 for specific usage.

Anticlockwise arc interpolation [CCW]			
16-bit instruction	-	32-bit instruction	CCW
Execution condition	Rise/fall edge of coil	Suitable model	XDM, XDME, XLME, XDH
Firmware	V3.3 and above	Software	V3.3 and above

## 2. Operand

Operand	Function	Type
S0	Axis 1 target position	Double words, 32-bit
S1	Axis 2 target position	Double words, 32-bit
S2	Specify the center position of axis 1 (always relative to the starting coordinates)	Double words, 32-bit
S3	Specify the center position of axis 2 (always relative to the starting coordinates)	Double words, 32-bit
D0	Pulse output port of axis 1	Bit
D1	Pulse output port of axis 2	Bit

## 3. Suitable soft component

Word	Operand	System								Constant	Module	
		D*	FD	TD*	CD*	DX	DY	DM*	DS*	K/H	ID	QD
	S0	•	•	•	•							
	S1	•	•	•	•							
	S2	•	•	•	•							
	S3	•	•	•	•							

Bit	Operand	System						
		X	Y	M*	S*	T*	C*	Dnm
	D0		•					
	D1		•					

\* Note: D denotes D HD; TD denotes TD HTD; CD denotes CD HCD HSCD HSD; DM denotes DM DHM; DS denotes DS DHS; M denotes M HM SM; S denotes S HS; T denotes T HT; C denotes C HC.

## 4. Parameter setting

Related parameters	Setting	Note
Final position	Determine the end point position according to relative/absolute mode	Must set
Relative/absolute	Relative: the above position as a reference; absolute: the origin as a reference	Must set
Circle center position	The position of the center is determined by the position of the starting point and the end point	Must set
Pulse output port of axis 1	Arbitrary specify pulse output point	Must set
Pulse output port of axis 2	Arbitrary specify pulse output point	Must set
Direction port of axis 1	Arbitrarily specify idle output points, set in system parameters	Must set
Direction port of axis 2	Arbitrarily specify idle output points, set in system parameters	Must set
Pulse unit	The pulse number or equivalent are acceptable. Set in axis 1 system parameters	Must set
Default speed	set in axis 1 group 2 parameters	Must set
Acceleration time	Set in axis 1 group 2 parameters	No need to set
Deceleration time	Set in axis 1 group 2 parameters	No need to set

**Function and action**

《Instruction format》

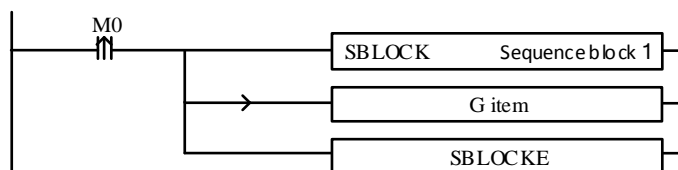

When the CCW instruction of arc interpolation (mode 1) is executed, the two axes will run at the highest synthesis speed. As shown in the following figure:

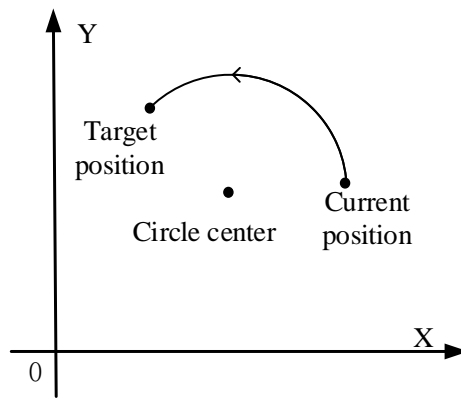

CCW clockwise arc interpolation

The parameter configuration is shown in the following figure:

Double-click G item and pop up the configuration panel. Set it as follows:

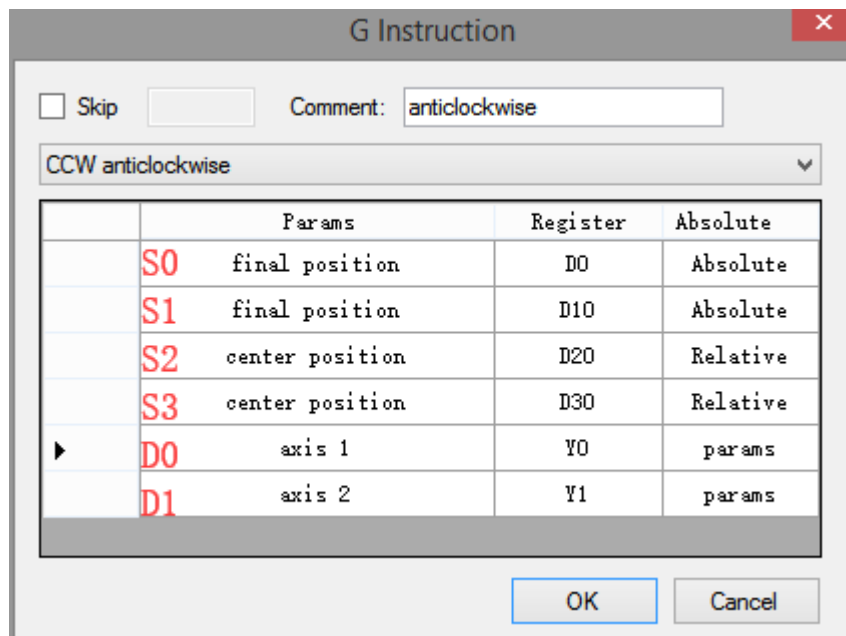

Instruction configuration



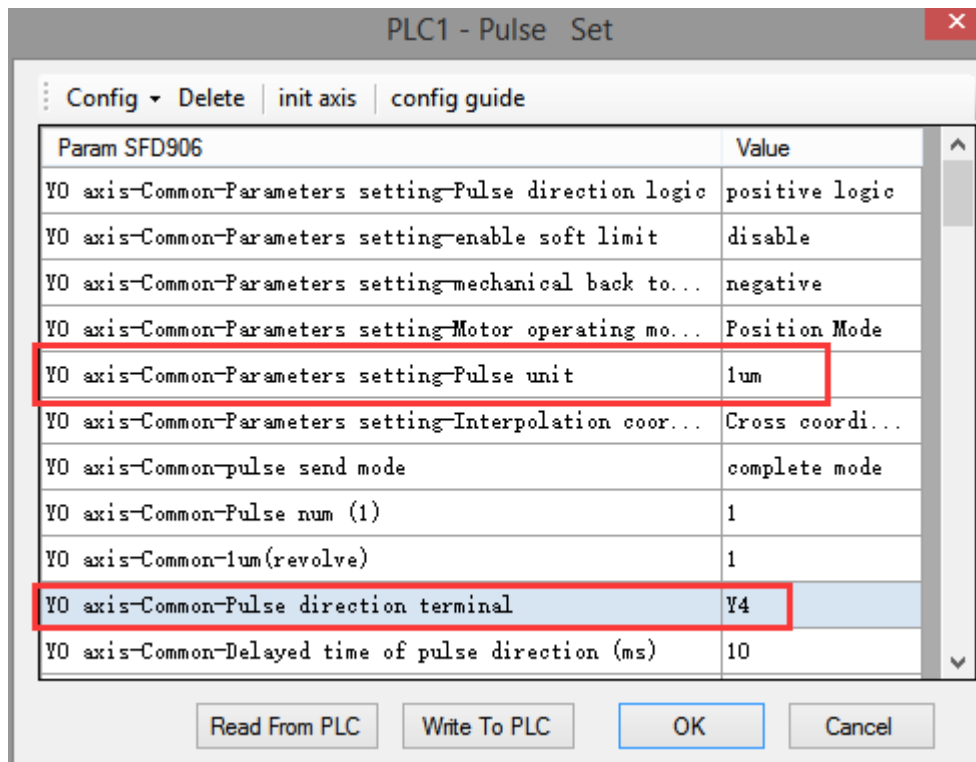

Axis Y0 system parameters (1)

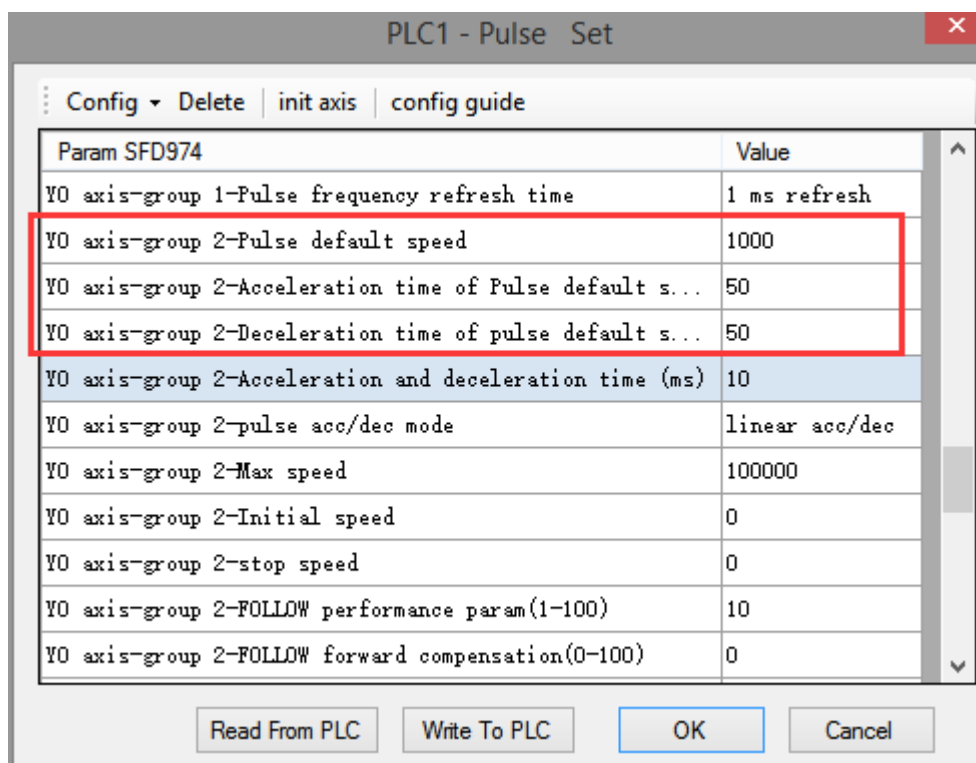

Axis Y0 system parameters (2)

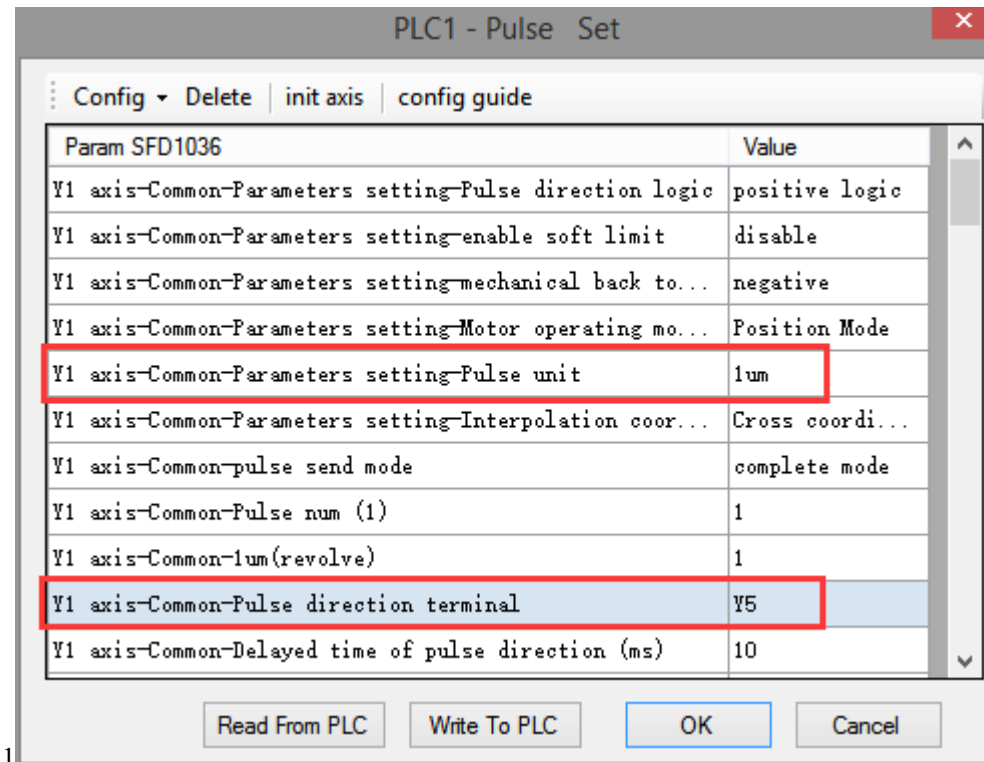

Axis Y1 system parameters

- As shown in the figure, D0 specifies the final position of axis 1 and D10 specifies the final position of axis 2, D20 specifies the circle center of axis 1, D30 specifies the circle center of axis 2.
  - Y0 is the pulse output port of axis 1 and Y1 is the pulse output port of axis 2. See Sections 2-3 for other optional ports.
  - The directional terminals are Y4 and Y5, it is ON for the forward pulse and OFF for the reverse pulse.
  - Pulse frequency range: 1Hz ~ 100KHz; Acceleration and deceleration time: 0 ~ 65535ms.
  - Location movement can be viewed in equivalent cumulative registers HSD2 and HSD6.
  - Assuming HSD2 = 1000, HSD6 = 1000, D0 = 5000, D10 = 2000, when M0 rises, execute CCW command, move from the starting position (1000, 1000) to the target position at the default speed of 1000Hz.
- (1) When the end point is in absolute mode, the target position is (5000,2000), the center position is (3000,1500), and D20 = 2000, D30 = 500.
- (2) When the end point is in the relative mode, the target position is (6000,3000), the center position is (3500,2000), and D20 = 2500, D30 = 1000.
- When the CCW instruction is running, the pulse flag bit corresponding to its output port Y will be set on.
  - The completion of the interpolation instruction can be judged by BLOCK executing flag bit. For example, the flag bit of BLOCK1 is SM300, when SM300 changes from ON to OFF, it means that BLOCK1 has finished executing.

### Mode 2: CCW anticlockwise VM

#### 1. Instruction overview

Anticlockwise arc interpolation instruction, operate according to the set maximum synthetic speed. This instruction can only be used in BLOCK. See Section 2-2 for specific usage.

Anticlockwise arc interpolation [CCW]			
16-bit instruction	-	32-bit instruction	CCW
Execution condition	Rise/fall edge of coil	Suitable model	XDM, XDME, XLME, XDH
Firmware	V3.3 and above	Software	V3.3 and above

#### 2. Operand

Operand	Function	Type
S0	Axis 1 target position	Double words, 32-bit
S1	Axis 2 target position	Double words, 32-bit
S2	Specify the center position of axis 1 (always relative to the starting coordinates)	Double words, 32-bit
S3	Specify the center position of axis 2 (always relative to the starting coordinates)	Double words, 32-bit
S4	Max speed of the two axes	Double words, 32-bit
D0	Pulse output port of axis 1	Bit
D1	Pulse output port of axis 2	Bit

#### 3. Suitable soft component

Word	Operand	System								Constant	Module	
		D*	FD	TD*	CD*	DX	DY	DM*	DS*	K/H	ID	QD
	S0	•	•	•	•							
	S1	•	•	•	•							
	S2	•	•	•	•							
	S3	•	•	•	•							
	S4	•	•	•	•							
Bit	Operand	System										
		X	Y	M*	S*	T*	C*	Dnm				
	D0		•									
	D1		•									

\* Note: D denotes D HD; TD denotes TD HTD; CD denotes CD HCD HSCD HSD; DM denotes DM DHM; DS denotes DS DHS; M denotes M HM SM; S denotes S HS; T denotes T HT; C denotes C HC.

## 4. Parameter setting

Related parameters	Setting	Note
Final position	Determine the end point position according to relative/absolute mode	Must set
Relative/absolute	Relative: the above position as a reference; absolute: the origin as a reference	Must set
Circle center position	The position of the center is determined by the position of the starting point and the end point	Must set
Max speed	Specify maximum smooth running speed of two axes	Must set
Pulse output port of axis 1	Arbitrary specify pulse output point	Must set
Pulse output port of axis 2	Arbitrary specify pulse output point	Must set
Direction port of axis 1	Arbitrarily specify idle output points, set in system parameters	Must set
Direction port of axis 2	Arbitrarily specify idle output points, set in system parameters	Must set
Pulse unit	The pulse number or equivalent are acceptable. Set in axis 1 system parameters	Must set
Default speed	set in axis 1 group 2 parameters	No need to set
Acceleration time	Set in axis 1 group 2 parameters	No need to set
Deceleration time	Set in axis 1 group 2 parameters	No need to set

**Function and action**

《Instruction format》

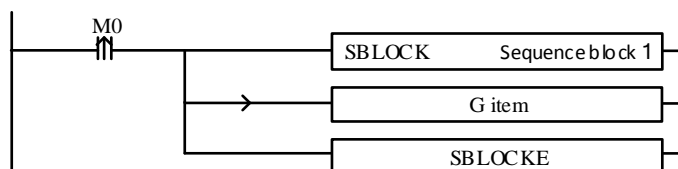

When the CCW instruction of arc interpolation (mode 2) is executed, the two axes will run at the set max synthesis speed. As shown in the following figure:

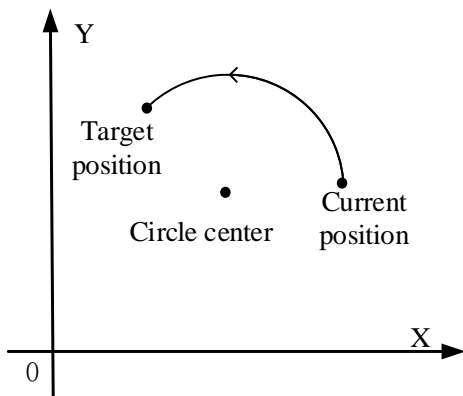

CCW clockwise arc interpolation

The parameter configuration is shown in the following figure:  
 Double-click G item and pop up the configuration panel. Set it as follows:

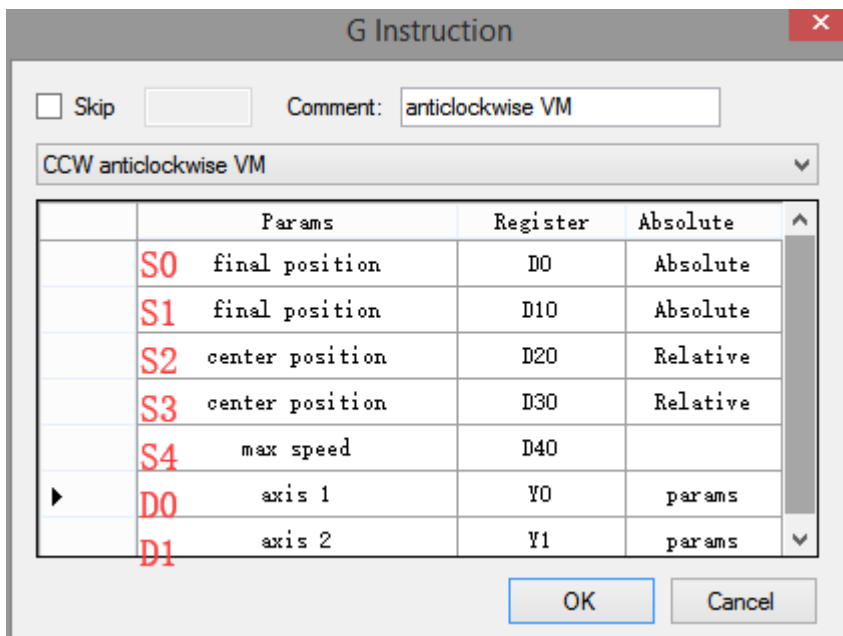

Instruction configuration

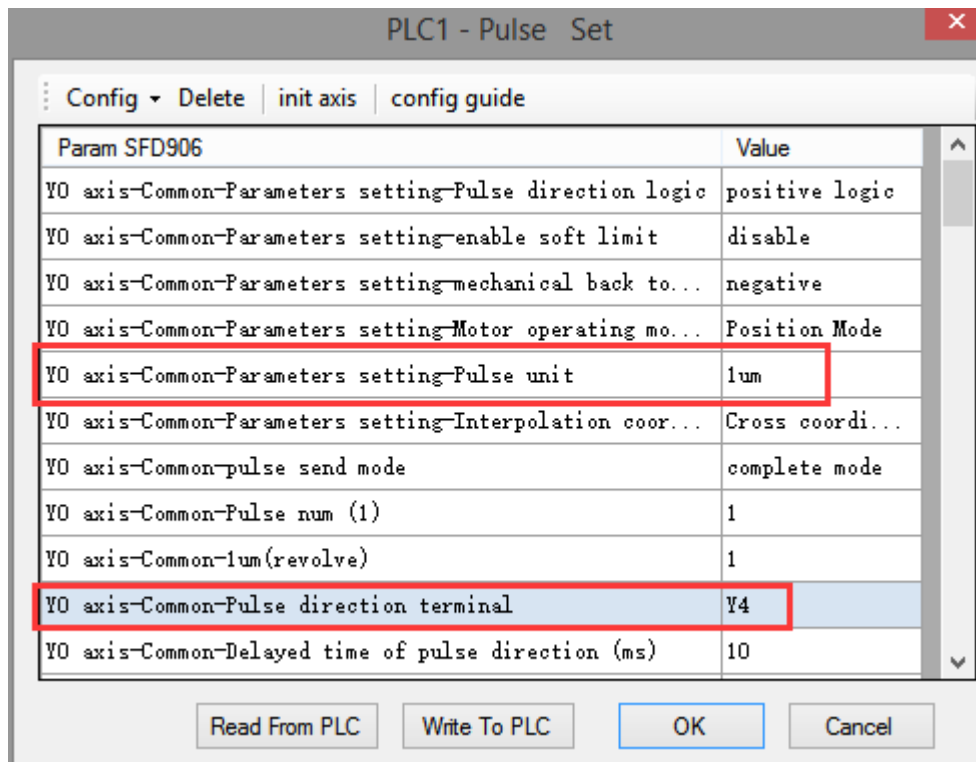

Axis Y0 system parameters (1)

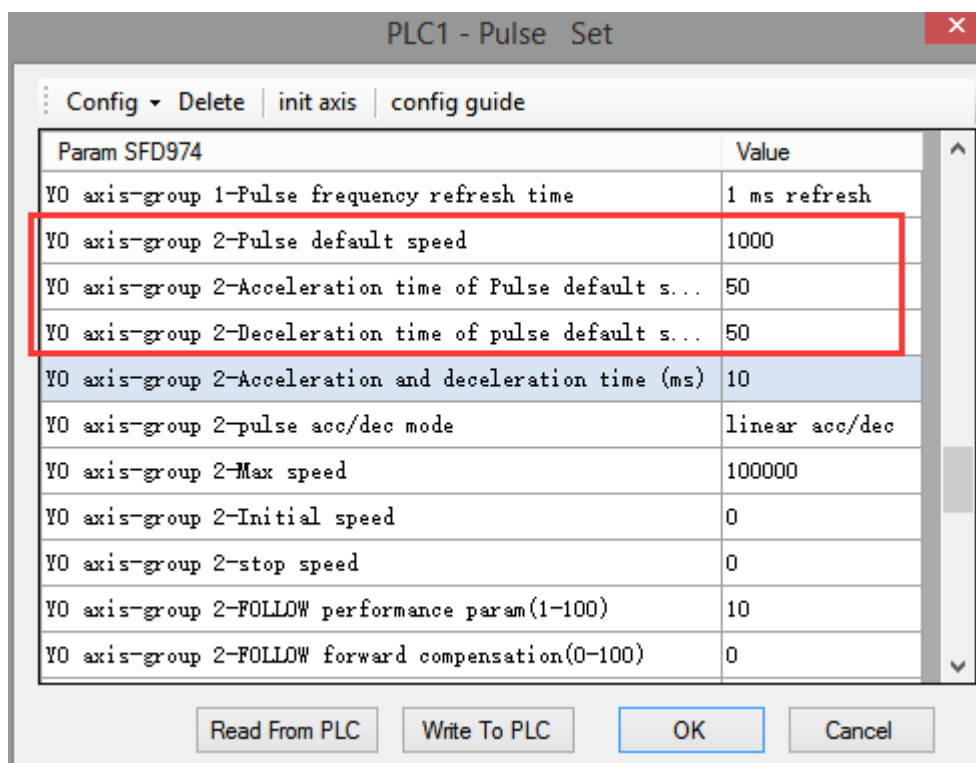

Axis Y0 system parameters (2)

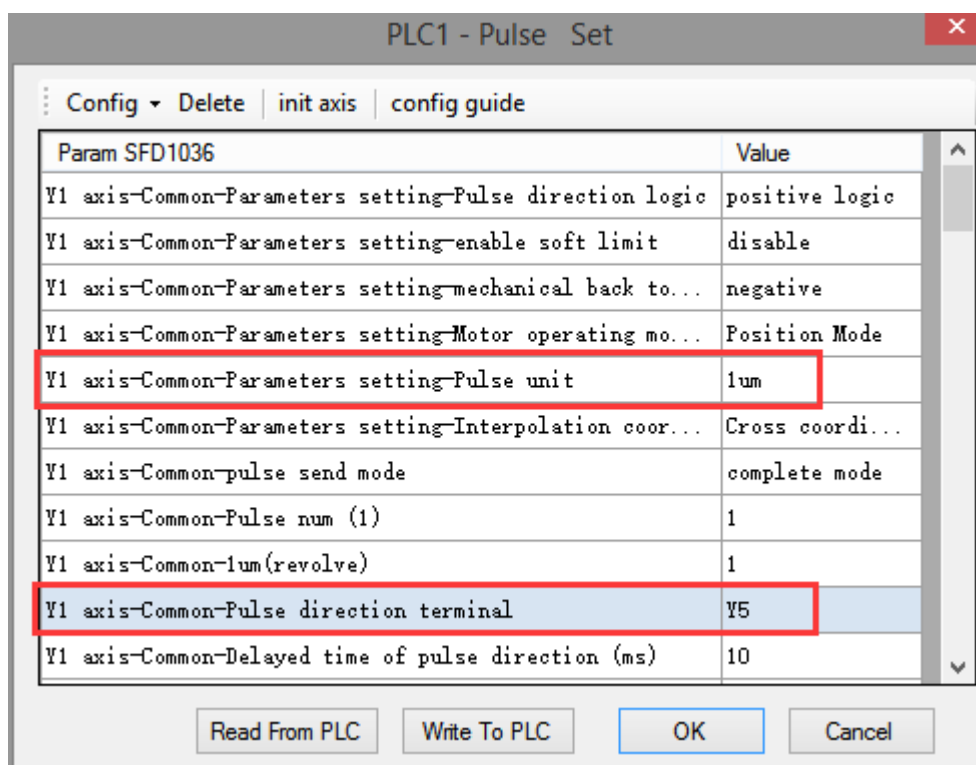

Axis Y1 system parameters

- As shown in the figure, D0 specifies the final position of axis 1 and D10 specifies the final position of axis 2, D20 specifies the circle center of axis 1, D30 specifies the circle center of axis 2, D40 specifies the max speed.
- Y0 is the pulse output port of axis 1 and Y1 is the pulse output port of axis 2. See Sections 2-3 for other optional ports.
- The directional terminals are Y4 and Y5, it is ON for the forward pulse and OFF for the reverse pulse.
- Pulse frequency range: 1Hz ~ 100KHz; Acceleration and deceleration time: 0 ~ 65535ms.
- Location movement can be viewed in equivalent cumulative registers HSD2 and HSD6.
- Assuming HSD2 = 1000, HSD6 = 1000, D0 = 5000, D10 = 2000, D40 = 500Hz, when M0 rises, execute CCW command, move from the starting position (1000, 1000) to the target position at the max speed of 500Hz.
  - (1) When the end point is in absolute mode, the target position is (5000,2000), the center position is (3000,1500), and D20 = 2000, D30 = 500.
  - (2) When the end point is in the relative mode, the target position is (6000,3000), the center position is (3500,2000), and D20 = 2500, D30 = 1000.
- When the CCW instruction is running, the pulse flag bit corresponding to its output port Y will be set on.
- The completion of the interpolation instruction can be judged by BLOCK executing flag bit. For example, the flag bit of BLOCK1 is SM300, when SM300 changes from ON to OFF, it means that BLOCK1 has finished executing.

### Mode 3: CCW anticlockwise VBEM

#### 1. Instruction overview

Anticlockwise arc interpolation instruction, operate according to the set maximum synthetic speed, start speed and stop speed. This instruction can only be used in BLOCK. See Section 2-2 for specific usage.

Anticlockwise arc interpolation [CCW]			
16-bit instruction	-	32-bit instruction	CCW
Execution condition	Rise/fall edge of coil	Suitable model	XDM, XDME, XLME, XDH
Firmware	V3.3 and above	Software	V3.3 and above

#### 2. Operand

Operand	Function	Type
S0	Axis 1 target position	Double words, 32-bit
S1	Axis 2 target position	Double words, 32-bit
S2	Specify the center position of axis 1 (always relative to the starting coordinates)	Double words, 32-bit
S3	Specify the center position of axis 2 (always relative to the starting coordinates)	Double words, 32-bit
S4	Specify the starting speed at the starting point of the two axes	Double words, 32-bit
S5	Specify the stop speed at the end point of the two axes	Double words, 32-bit
S6	Max speed of the two axes	Double words, 32-bit
D0	Pulse output port of axis 1	Bit
D1	Pulse output port of axis 2	Bit

#### 3. Suitable soft component

Word	Operand	System							Constant	Module		
		D*	FD	TD*	CD*	DX	DY	DM*	DS*	K/H	ID	QD
	S0~S6	•	•	•	•							
Bit	Operand	System										
		X	Y	M*	S*	T*	C*	Dnm				
	D0		•									
	D1		•									

\* Note: D denotes D HD; TD denotes TD HTD; CD denotes CD HCD HSCD HSD; DM denotes DM DHM; DS denotes DS DHS; M denotes M HM SM; S denotes S HS; T denotes T HT; C denotes C HC.



## 4. Parameter setting

Related parameters	Setting	Note
Final position	Determine the end point position according to relative/absolute mode	Must set
Relative/absolute	Relative: the above position as a reference; absolute: the origin as a reference	Must set
Circle center position	The position of the center is determined by the position of the starting point and the end point	Must set
Max speed	Specify maximum smooth running speed of two axes	Must set
Start speed	The start speed from the starting point	Must set
Stop speed	The stop speed at the end point	Must set
Pulse output port of axis 1	Arbitrary specify pulse output point	Must set
Pulse output port of axis 2	Arbitrary specify pulse output point	Must set
Direction port of axis 1	Arbitrarily specify idle output points, set in system parameters	Must set
Direction port of axis 2	Arbitrarily specify idle output points, set in system parameters	Must set
Pulse unit	The pulse number or equivalent are acceptable. Set in axis 1 system parameters	Must set
Default speed	set in axis 1 group 2 parameters	No need to set
Acceleration time	Set in axis 1 group 2 parameters	No need to set
Deceleration time	Set in axis 1 group 2 parameters	No need to set

**Function and action**

《Instruction format》

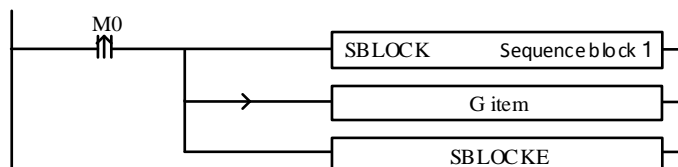

When the CCW instruction of arc interpolation (mode 3) is executed, the two axes will run at the set max synthesis speed, start speed and stop speed. As shown in the following figure:

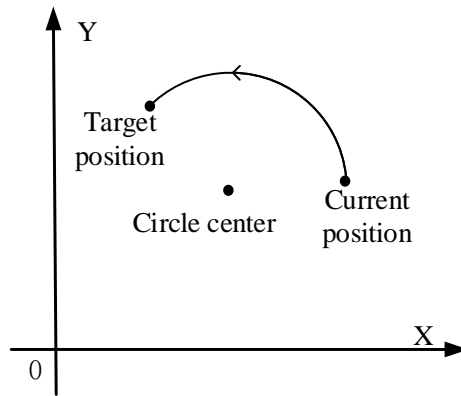

CCW clockwise arc interpolation

The parameter configuration is shown in the following figure:

Double-click G item and pop up the configuration panel. Set it as follows:

**G Instruction** ✕

Skip    Comment:

CCW anticlockwise VBEM ▾

	Params	Register	Absolute
<b>S0</b>	final position	D0	Absolute
<b>S1</b>	final position	D10	Absolute
<b>S2</b>	center position	D20	Relative
<b>S3</b>	center position	D30	Relative
<b>S4</b>	begin speed	D40	
<b>S5</b>	end speed	D50	
<b>S6</b>	max speed	D60	

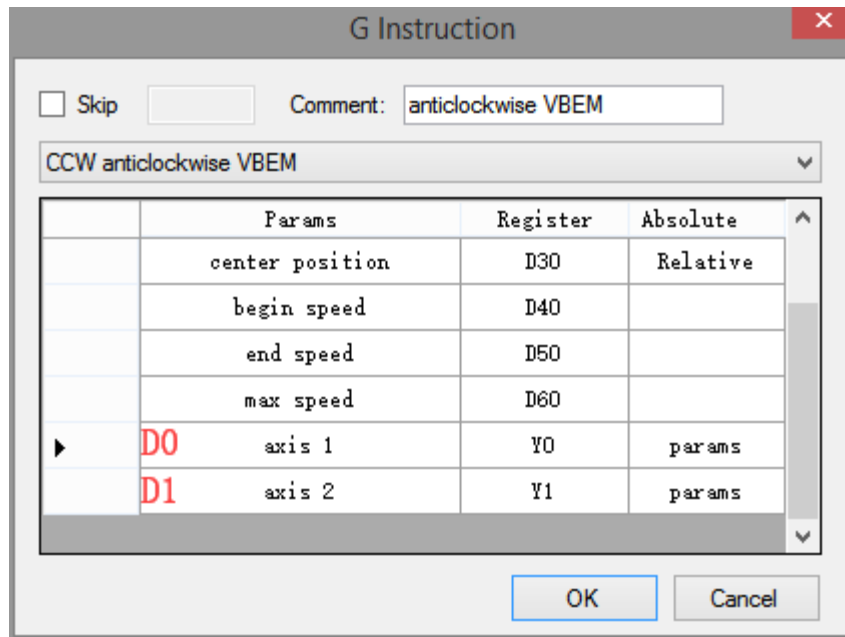

Instruction configuration

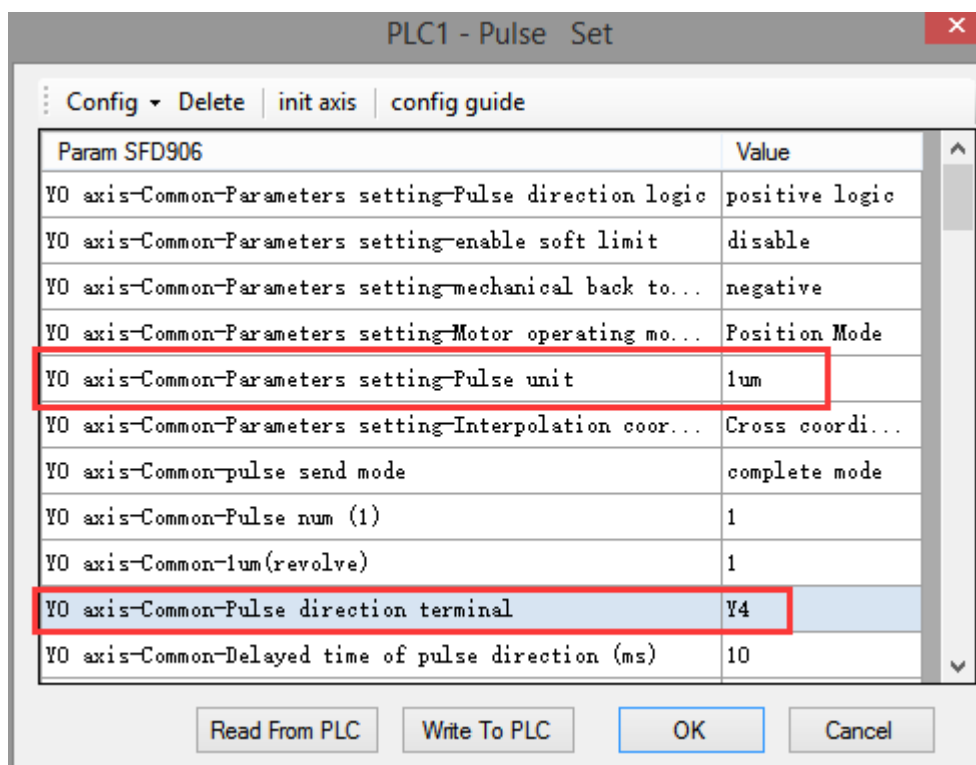

Axis Y0 system parameters (1)

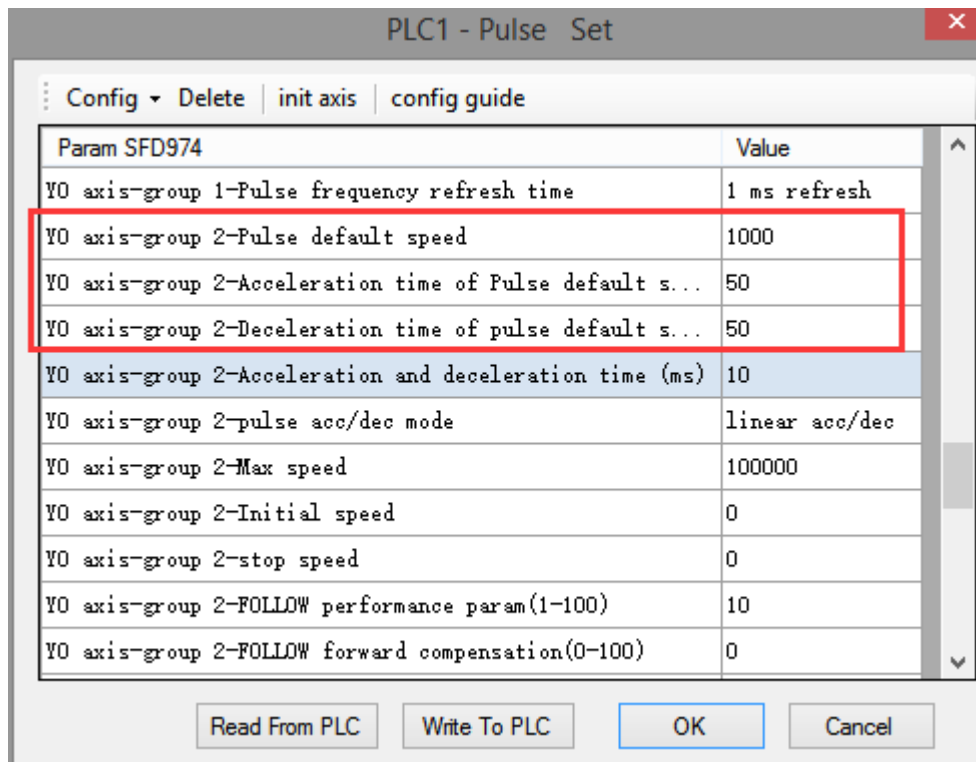

Axis Y0 system parameters (2)

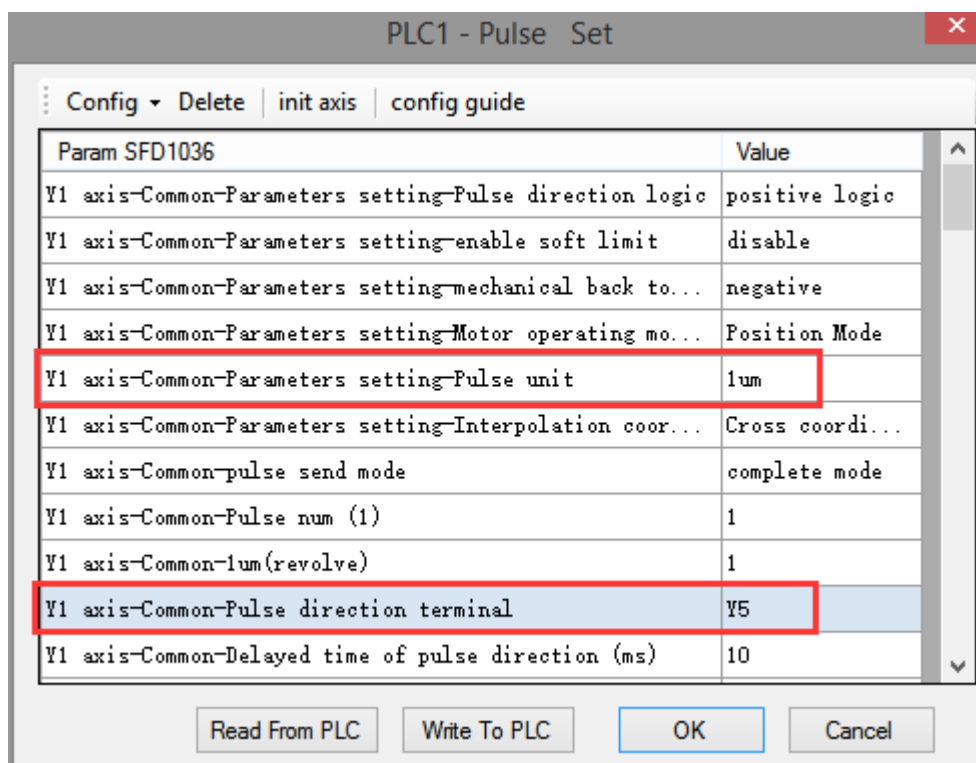

Axis Y1 system parameters

- As shown in the figure, D0 specifies the final position of axis 1 and D10 specifies the final position of axis 2, D20 specifies the circle center of axis 1, D30 specifies the circle center of axis 2, D40 specifies the start speed, D50 specifies the stop speed, D60 specifies the max

speed.

- Y0 is the pulse output port of axis 1 and Y1 is the pulse output port of axis 2. See Sections 2-3 for other optional ports.
- The directional terminals are Y4 and Y5, it is ON for the forward pulse and OFF for the reverse pulse.
- Pulse frequency range: 1Hz ~ 100KHz; Acceleration and deceleration time: 0 ~ 65535ms.
- Location movement can be viewed in equivalent cumulative registers HSD2 and HSD6.
- Assuming HSD2 = 1000, HSD6 = 1000, D0 = 5000, D10 = 2000, D40 = 50Hz, D50 = 20, D60 = 2000, when M0 rises, execute CCW command, accelerate from the starting position (1000,1000) at speed 50Hz to the maximum speed (2000Hz), and stop at the end speed of 20Hz when moving to the target position.

(1) When the end point is in absolute mode, the target position is (5000,2000), the center position is (3000,1500), and D20 = 2000, D30 = 500.

(2) When the end point is in the relative mode, the target position is (6000,3000), the center position is (3500,2000), and D20 = 2500, D30 = 1000.

- When the CCW instruction is running, the pulse flag bit corresponding to its output port Y will be set on.
- The completion of the interpolation instruction can be judged by BLOCK executing flag bit. For example, the flag bit of BLOCK1 is SM300, when SM300 changes from ON to OFF, it means that BLOCK1 has finished executing.

Note: In this mode, the starting speed (S4), the ending speed (S5) and the maximum speed (S6) are all expressed as the two-axis synthesis speed, as shown in the following figure:

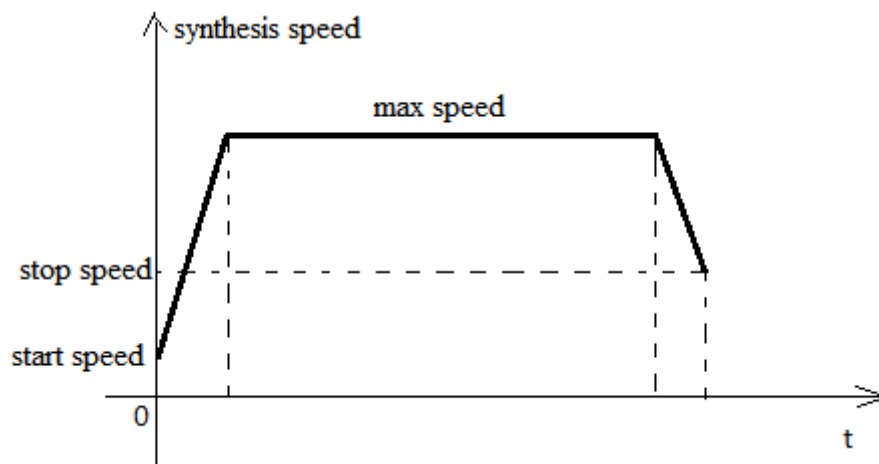

When there are multiple continuous linear/arc interpolation instructions and the speed between them needs to be constant and jump directly, the termination speed and maximum speed of the previous linear/arc interpolation can be set the same as the starting speed and maximum speed of the next segment.

When mode 3 is used, the starting and ending speed in the pulse parameter configuration tables of axis 1 and axis 2 are only effective for calculating the slope of pulse acceleration and deceleration.

### 2-4-6. Clockwise arc [CW\_R]

Clockwise arc interpolation CW\_R is mainly based on the current position of the arc, the target position and the length of the radius of the circle, clockwise to determine a section of the arc, as shown in the following figure:

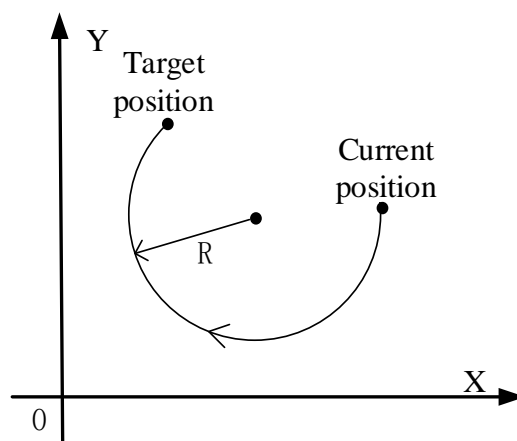

With the above figure, when the target position is set at the same position as the current one, the next circle can not be determined, so this mode can not draw a whole circle. There are three modes of CW\_R. The usage of CW\_R is described below.

#### Mode 1: CW\_R clockwise arc

##### 1. Instruction overview

Clockwise arc interpolation instruction, operate according to the set default speed. This instruction can only be used in BLOCK. See Section 2-2 for specific usage.

Clockwise arc interpolation [CW_R]			
16-bit instruction	-	32-bit instruction	CW_R
Execution condition	Rise/fall edge of coil	Suitable model	XDM, XDME, XLME, XDH
Firmware	V3.3 and above	Software	V3.3 and above

##### 2. Operand

Operand	Function	Type
S0	Axis 1 target position	Double words, 32-bit
S1	Axis 2 target position	Double words, 32-bit
S2	Specify the radius of the arc	Double words, 32-bit
D0	Pulse output port of axis 1	Bit
D1	Pulse output port of axis 2	Bit

## 3. Suitable soft component

Word	Operand	System								Constant	Module	
		D*	FD	TD*	CD*	DX	DY	DM*	DS*	K/H	ID	QD
	S0	•	•	•	•							
	S1	•	•	•	•							
	S2	•	•	•	•							

Bit	Operand	System						
		X	Y	M*	S*	T*	C*	Dnm
	D0		•					
	D1		•					

\* Note: D denotes D HD; TD denotes TD HTD; CD denotes CD HCD HSCD HSD; DM denotes DM DHM; DS denotes DS DHS; M denotes M HM SM; S denotes S HS; T denotes T HT; C denotes C HC.

## 4. Parameter setting

Related parameters	Setting	Note
Final position	Determine the end point position according to relative/absolute mode	Must set
Relative/absolute	Relative: the above position as a reference; absolute: the origin as a reference	Must set
Radius	The path of an arc varies with its radius.	Must set
Pulse output port of axis 1	Arbitrary specify pulse output point	Must set
Pulse output port of axis 2	Arbitrary specify pulse output point	Must set
Direction port of axis 1	Arbitrarily specify idle output points, set in system parameters	Must set
Direction port of axis 2	Arbitrarily specify idle output points, set in system parameters	Must set
Pulse unit	The pulse number or equivalent are acceptable. Set in axis 1 system parameters	Must set
Default speed	set in axis 1 group 2 parameters	Must set
Acceleration time	Set in axis 1 group 2 parameters	No need to set
Deceleration time	Set in axis 1 group 2 parameters	No need to set

## Function and action

«Instruction format»

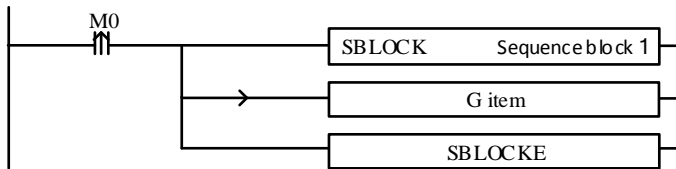

When the CW\_R instruction of arc interpolation (mode 1) is executed, the two axes will run at the highest synthesis speed. As shown in the following figure:

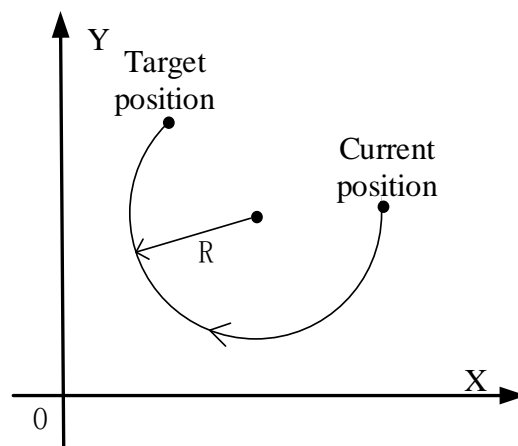

CW\_R clockwise arc interpolation

The parameter configuration is shown in the following figure:

Double-click G item and pop up the configuration panel. Set it as follows:

**G Instruction** ✕

Skip    Comment:

CW\_R clockwise ▾

	Params	Register	Absolute
	<b>S0</b> final position	D0	Absolute
	<b>S1</b> final position	D10	Absolute
	<b>S2</b> radius	D20	
▶	<b>D0</b> axis 1	Y0	params
	<b>D1</b> axis 2	Y1	params



## Instruction configuration

PLC1 - Pulse Set

Config ▾ Delete | init axis | config guide

Param SFD906	Value
Y0 axis-Common-Parameters setting-Pulse direction logic	positive logic
Y0 axis-Common-Parameters setting-enable soft limit	disable
Y0 axis-Common-Parameters setting-mechanical back to...	negative
Y0 axis-Common-Parameters setting-Motor operating mo...	Position Mode
Y0 axis-Common-Parameters setting-Pulse unit	1um
Y0 axis-Common-Parameters setting-Interpolation coor...	Cross coordi...
Y0 axis-Common-pulse send mode	complete mode
Y0 axis-Common-Pulse num (1)	1
Y0 axis-Common-1um(revolve)	1
Y0 axis-Common-Pulse direction terminal	Y4
Y0 axis-Common-Delayed time of pulse direction (ms)	10

Read From PLC Write To PLC OK Cancel

Axis Y0 system parameters (1)

PLC1 - Pulse Set

Config ▾ Delete | init axis | config guide

Param SFD974	Value
Y0 axis-group 1-Pulse frequency refresh time	1 ms refresh
Y0 axis-group 2-Pulse default speed	1000
Y0 axis-group 2-Acceleration time of Pulse default s...	50
Y0 axis-group 2-Deceleration time of pulse default s...	50
Y0 axis-group 2-Acceleration and deceleration time (ms)	10
Y0 axis-group 2-pulse acc/dec mode	linear acc/dec
Y0 axis-group 2-Max speed	100000
Y0 axis-group 2-Initial speed	0
Y0 axis-group 2-stop speed	0
Y0 axis-group 2-FOLLOW performance param(1-100)	10
Y0 axis-group 2-FOLLOW forward compensation(0-100)	0

Read From PLC Write To PLC OK Cancel

Axis Y0 system parameters (2)

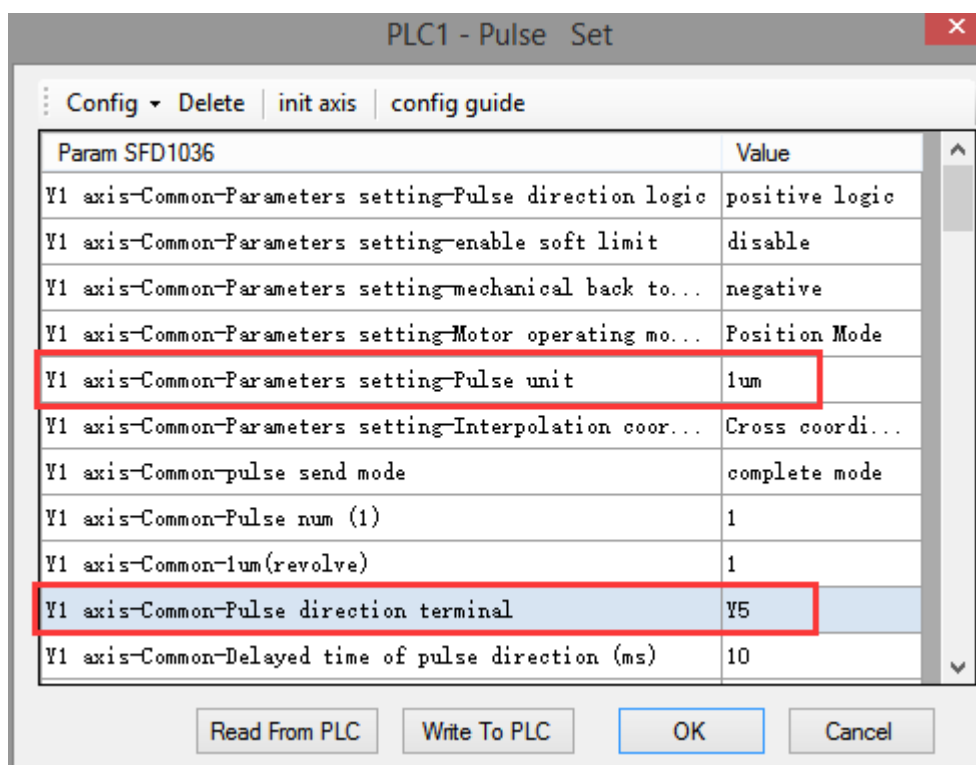

Axis Y1 system parameters

- As shown in the figure, D0 specifies the final position of axis 1 and D10 specifies the final position of axis 2, D20 specifies the circle radius. The path of an arc varies with its radius.
  - Y0 is the pulse output port of axis 1 and Y1 is the pulse output port of axis 2. See Sections 2-3 for other optional ports.
  - The directional terminals are Y4 and Y5, it is ON for the forward pulse and OFF for the reverse pulse.
  - Pulse frequency range: 1Hz ~ 100KHz; Acceleration and deceleration time: 0 ~ 65535ms.
  - Location movement can be viewed in equivalent cumulative registers HSD2 and HSD6.
  - Assuming HSD2 = 1000, HSD6 = 1000, D0 = 5000, D10 = 2000, when M0 rises, execute CW\_R command, move from the starting position (1000, 1000) to the target position at the default speed of 1000Hz.
- (1) When the end point is in absolute mode, the target position is (5000,2000)
  - (2) When the end point is in the relative mode, the target position is (6000,3000)
- When the CW\_R instruction is running, the pulse flag bit corresponding to its output port Y will be set on.
  - The completion of the interpolation instruction can be judged by BLOCK executing flag bit. For example, the flag bit of BLOCK1 is SM300, when SM300 changes from ON to OFF, it means that BLOCK1 has finished executing.
  - When the radius is positive, the arc is inferior; when the radius is negative, it is major arc.

**Mode 2: CW\_R clockwise arc VM**

## 1. Instruction overview

Clockwise arc interpolation instruction, operate according to the set maximum synthetic speed. This instruction can only be used in BLOCK. See Section 2-2 for specific usage.

Clockwise arc interpolation [CW_R]			
16-bit instruction	-	32-bit instruction	CW_R
Execution condition	Rise/fall edge of coil	Suitable model	XDM, XDME, XLME, XDH
Firmware	V3.3 and above	Software	V3.3 and above

## 2. Operand

Operand	Function	Type
S0	Axis 1 target position	Double words, 32-bit
S1	Axis 2 target position	Double words, 32-bit
S2	Specify the radius of the arc	Double words, 32-bit
S3	Max speed of the two axes	Double words, 32-bit
D0	Pulse output port of axis 1	Bit
D1	Pulse output port of axis 2	Bit

## 3. Suitable soft component

Word	Operand	System								Constant	Module	
		D*	FD	TD*	CD*	DX	DY	DM*	DS*	K/H	ID	QD
	S0	•	•	•	•							
	S1	•	•	•	•							
	S2	•	•	•	•							
	S3	•	•	•	•							

Bit	Operand	System						
		X	Y	M*	S*	T*	C*	Dnm
	D0		•					
	D1		•					

\* Note: D denotes D HD; TD denotes TD HTD; CD denotes CD HCD HSCD HSD; DM denotes DM DHM; DS denotes DS DHS; M denotes M HM SM; S denotes S HS; T denotes T HT; C denotes C HC.

## 4. Parameter setting

Related parameters	Setting	Note
Final position	Determine the end point position according to relative/absolute mode	Must set

Relative/absolute	Relative: the above position as a reference; absolute: the origin as a reference	Must set
Radius	The path of an arc varies with its radius.	Must set
Max speed	Specify maximum smooth running speed of two axes	Must set
Pulse output port of axis 1	Arbitrary specify pulse output point	Must set
Pulse output port of axis 2	Arbitrary specify pulse output point	Must set
Direction port of axis 1	Arbitrarily specify idle output points, set in system parameters	Must set
Direction port of axis 2	Arbitrarily specify idle output points, set in system parameters	Must set
Pulse unit	The pulse number or equivalent are acceptable. Set in axis 1 system parameters	Must set
Default speed	set in axis 1 group 2 parameters	No need to set
Acceleration time	Set in axis 1 group 2 parameters	No need to set
Deceleration time	Set in axis 1 group 2 parameters	No need to set

### Function and action

《Instruction format》

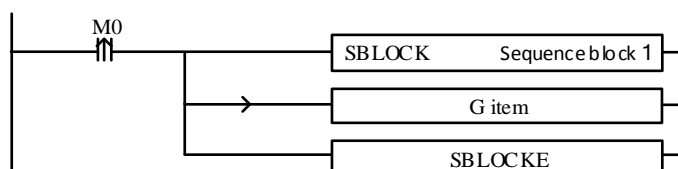

When the CW\_R instruction of arc interpolation (mode 2) is executed, the two axes will run at the set max synthesis speed. As shown in the following figure:

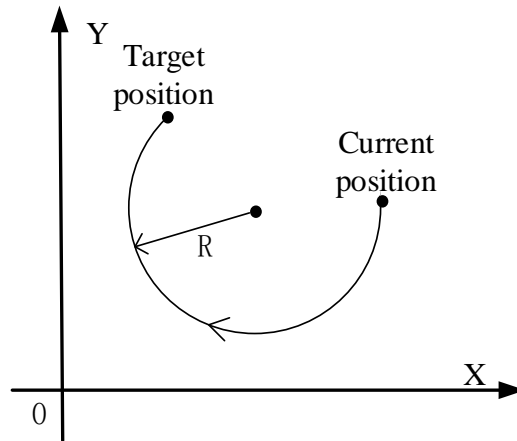

**CW\_R clockwise arc interpolation**

The parameter configuration is shown in the following figure:

Double-click G item and pop up the configuration panel. Set it as follows:

**G Instruction** ✕

Skip    Comment:

**CW\_R clockwise VM** ▾

	Params	Register	Absolute
	<b>S0</b> final position	D0	Absolute
	<b>S1</b> final position	D10	Absolute
	<b>S2</b> radius	D20	
	<b>S3</b> max speed	D30	
▶	<b>D0</b> axis 1	Y0	params
	<b>D1</b> axis 2	Y1	params

**Instruction configuration**

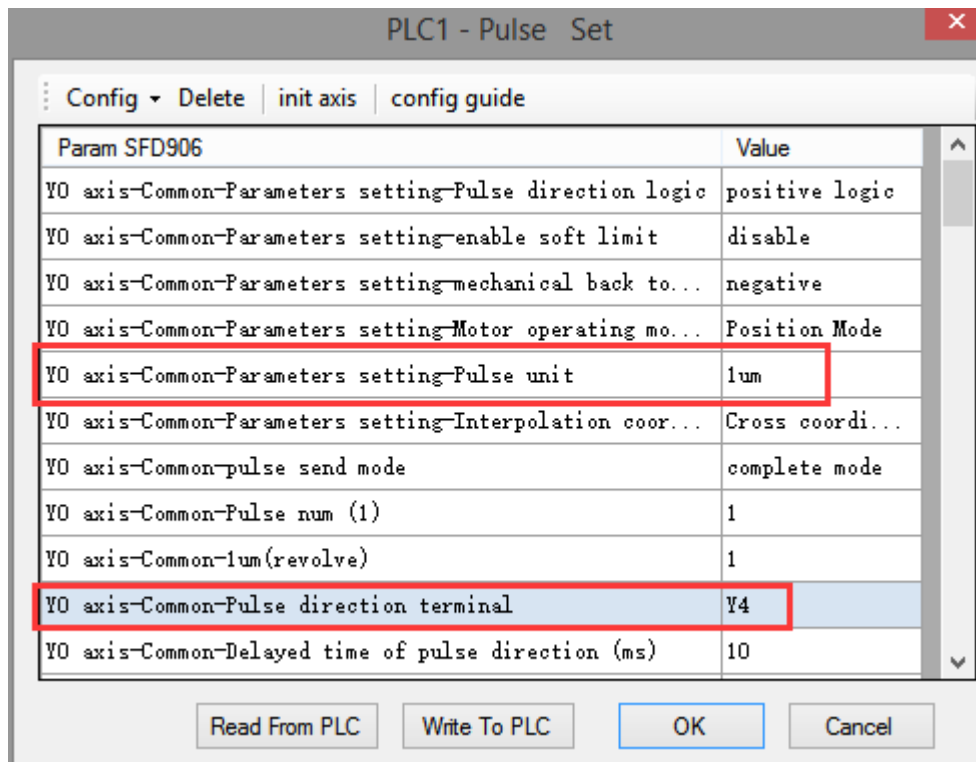

Axis Y0 system parameters (1)

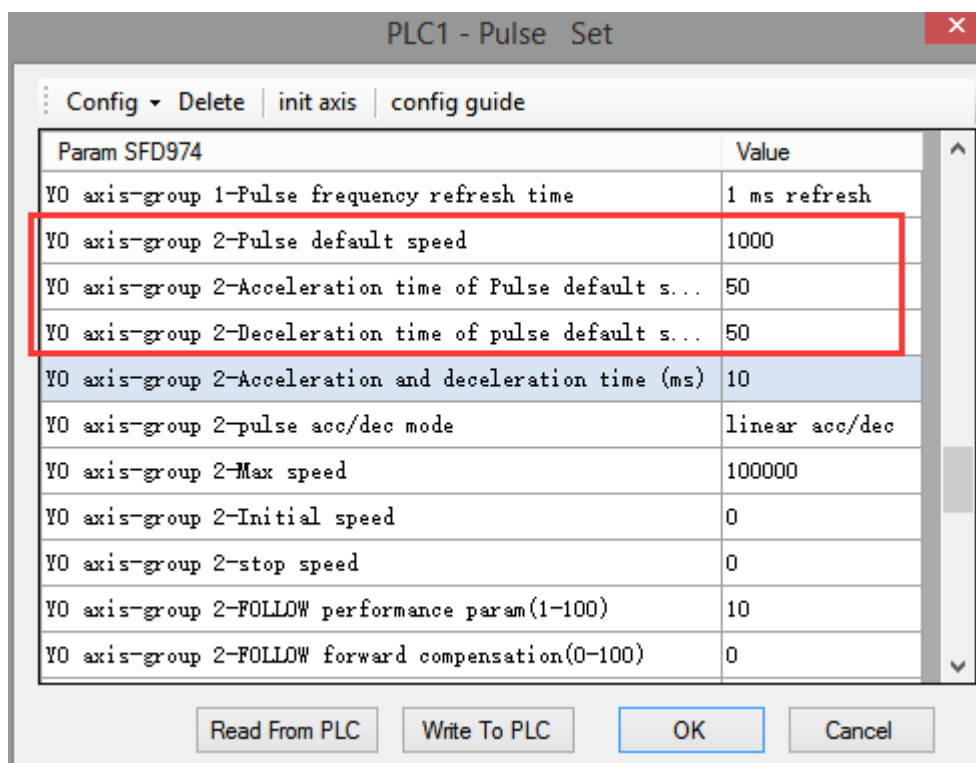

Axis Y0 system parameters (2)

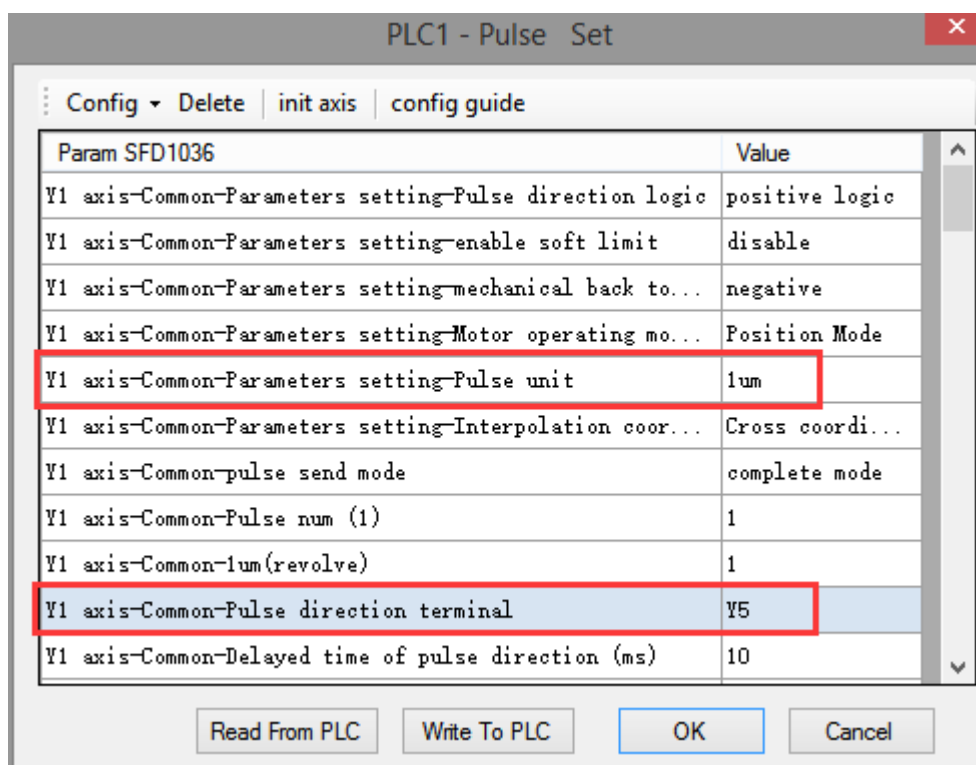

Axis Y1 system parameters

- As shown in the figure, D0 specifies the final position of axis 1 and D10 specifies the final position of axis 2, D20 specifies the radius (the radius is different and the path is different), D30 specifies the max speed.
- Y0 is the pulse output port of axis 1 and Y1 is the pulse output port of axis 2. See Sections 2-3 for other optional ports.
- The directional terminals are Y4 and Y5, it is ON for the forward pulse and OFF for the reverse pulse.
- Pulse frequency range: 1Hz ~ 100KHz; Acceleration and deceleration time: 0 ~ 65535ms.
- Location movement can be viewed in equivalent cumulative registers HSD2 and HSD6.
- Assuming HSD2 = 1000, HSD6 = 1000, D0 = 5000, D10 = 2000, D40 = 500Hz, when M0 rises, execute CW\_R command, move from the starting position (1000, 1000) to the target position at the max speed of 500Hz.
  - (1) When the end point is in absolute mode, the target position is (5000,2000)
  - (2) When the end point is in the relative mode, the target position is (6000,3000)
- When the CW\_R instruction is running, the pulse flag bit corresponding to its output port Y will be set on.
- The completion of the interpolation instruction can be judged by BLOCK executing flag bit. For example, the flag bit of BLOCK1 is SM300, when SM300 changes from ON to OFF, it means that BLOCK1 has finished executing.
- When the radius is positive, the arc is inferior; when the radius is negative, it is major arc.

**Mode 3: CW\_R clockwise arc VBEM**

## 1. Instruction overview

Clockwise arc interpolation instruction, operate according to the set maximum synthetic speed, start speed and stop speed. This instruction can only be used in BLOCK. See Section 2-2 for specific usage.

Clockwise arc interpolation [CW_R]			
16-bit instruction	-	32-bit instruction	CW_R
Execution condition	Rise/fall edge of coil	Suitable model	XDM, XDME, XLME, XDH
Firmware	V3.3 and above	Software	V3.3 and above

## 2. Operand

Operand	Function	Type
S0	Axis 1 target position	Double words, 32-bit
S1	Axis 2 target position	Double words, 32-bit
S2	Specify the radius of the arc	Double words, 32-bit
S3	Specify the starting speed at the starting point of the two axes	Double words, 32-bit
S4	Specify the stop speed at the end point of the two axes	Double words, 32-bit
S5	Max speed of the two axes	Double words, 32-bit
D0	Pulse output port of axis 1	Bit
D1	Pulse output port of axis 2	Bit

## 3. Suitable soft component

Word	Operand	System							Constant	Module		
		D*	FD	TD*	CD*	DX	DY	DM*	DS*	K/H	ID	QD
	S0~S5	•	•	•	•							
Bit	Operand	System										
		X	Y	M*	S*	T*	C*	Dnm				
	D0		•									
	D1		•									

\* Note: D denotes D HD; TD denotes TD HTD; CD denotes CD HCD HSCD HSD; DM denotes DM DHM; DS denotes DS DHS; M denotes M HM SM; S denotes S HS; T denotes T HT; C denotes C HC.



## 4. Parameter setting

Related parameters	Setting	Note
Final position	Determine the end point position according to relative/absolute mode	Must set
Relative/absolute	Relative: the above position as a reference; absolute: the origin as a reference	Must set
radius	The radius is different and the path is different	Must set
Max speed	Specify maximum smooth running speed of two axes	Must set
Start speed	The start speed from the starting point	Must set
Stop speed	The stop speed at the end point	Must set
Pulse output port of axis 1	Arbitrary specify pulse output point	Must set
Pulse output port of axis 2	Arbitrary specify pulse output point	Must set
Direction port of axis 1	Arbitrarily specify idle output points, set in system parameters	Must set
Direction port of axis 2	Arbitrarily specify idle output points, set in system parameters	Must set
Pulse unit	The pulse number or equivalent are acceptable. Set in axis 1 system parameters	Must set
Default speed	set in axis 1 group 2 parameters	No need to set
Acceleration time	Set in axis 1 group 2 parameters	No need to set
Deceleration time	Set in axis 1 group 2 parameters	No need to set

**Function and action**

《Instruction format》

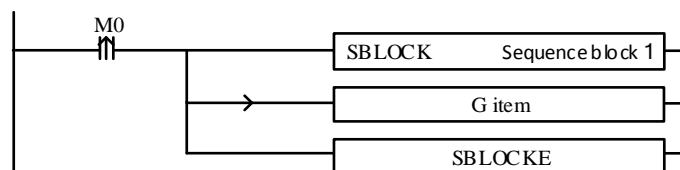

When the CW\_R instruction of arc interpolation (mode 3) is executed, the two axes will run at the set max synthesis speed, start speed and stop speed. As shown in the following figure:

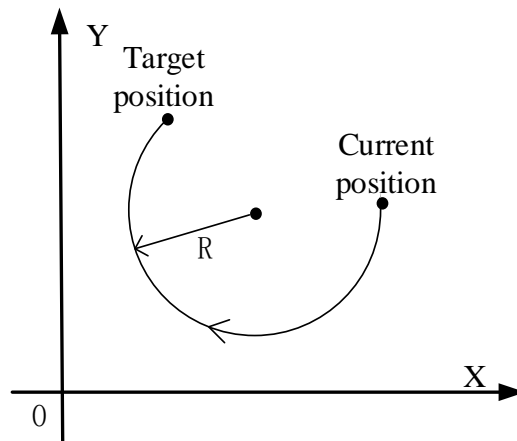

**CW\_R clockwise arc interpolation**

The parameter configuration is shown in the following figure:

Double-click G item and pop up the configuration panel. Set it as follows:

**G Instruction** ✕

Skip    Comment:

**CW\_R clockwise VBEM** ▾

	Params	Register	Absolute
<b>S0</b>	final position	D0	Absolute
<b>S1</b>	final position	D10	Absolute
<b>S2</b>	radius	D20	
<b>S3</b>	begin speed	D30	
<b>S4</b>	end speed	D40	
<b>S5</b>	max speed	D50	
▶	axis 1	Y0	params ▾

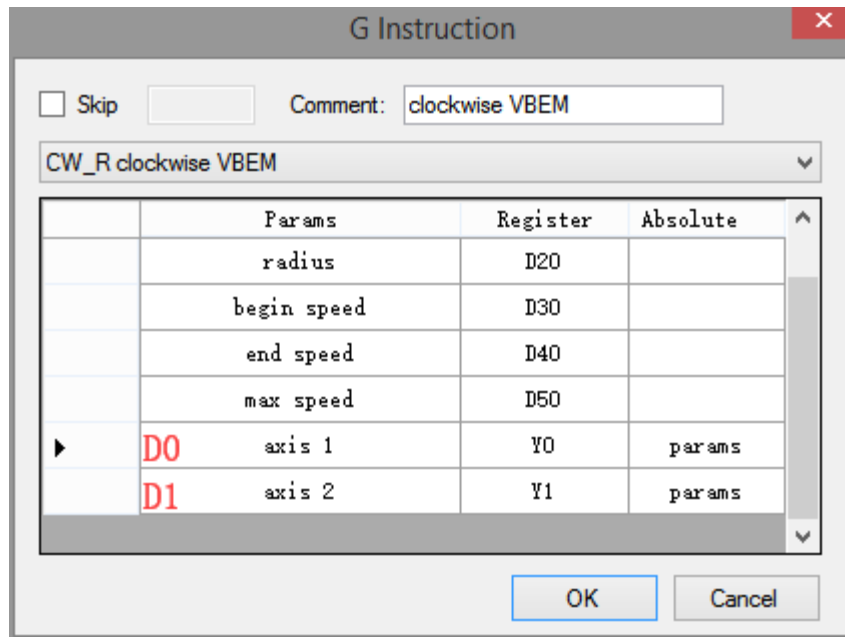

Instruction configuration

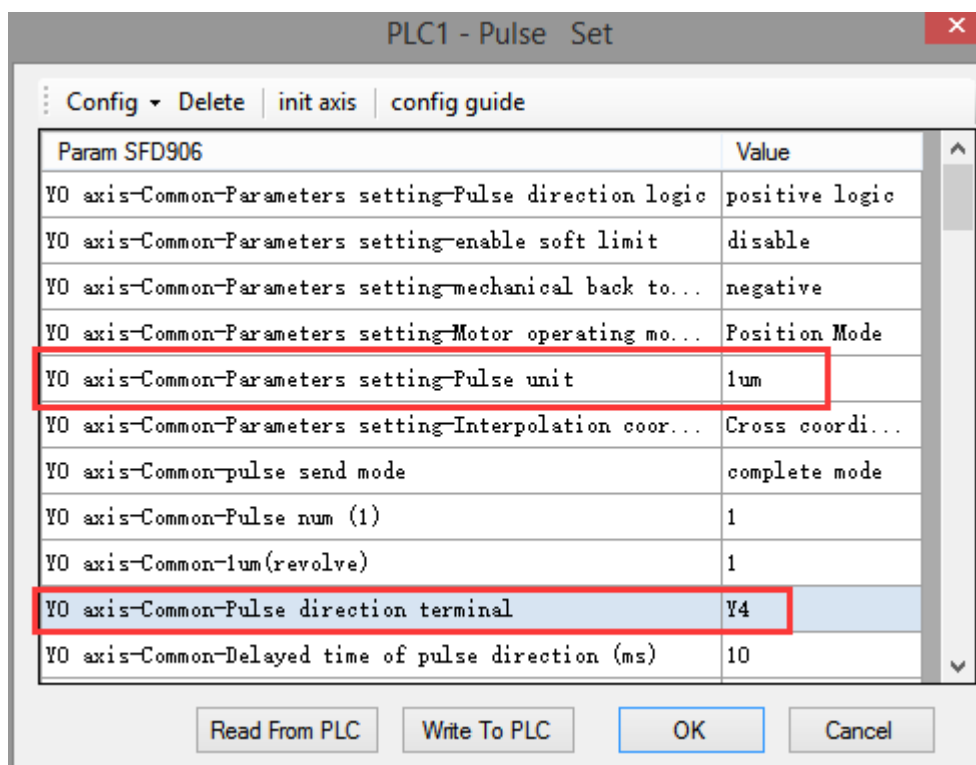

Axis Y0 system parameters (1)

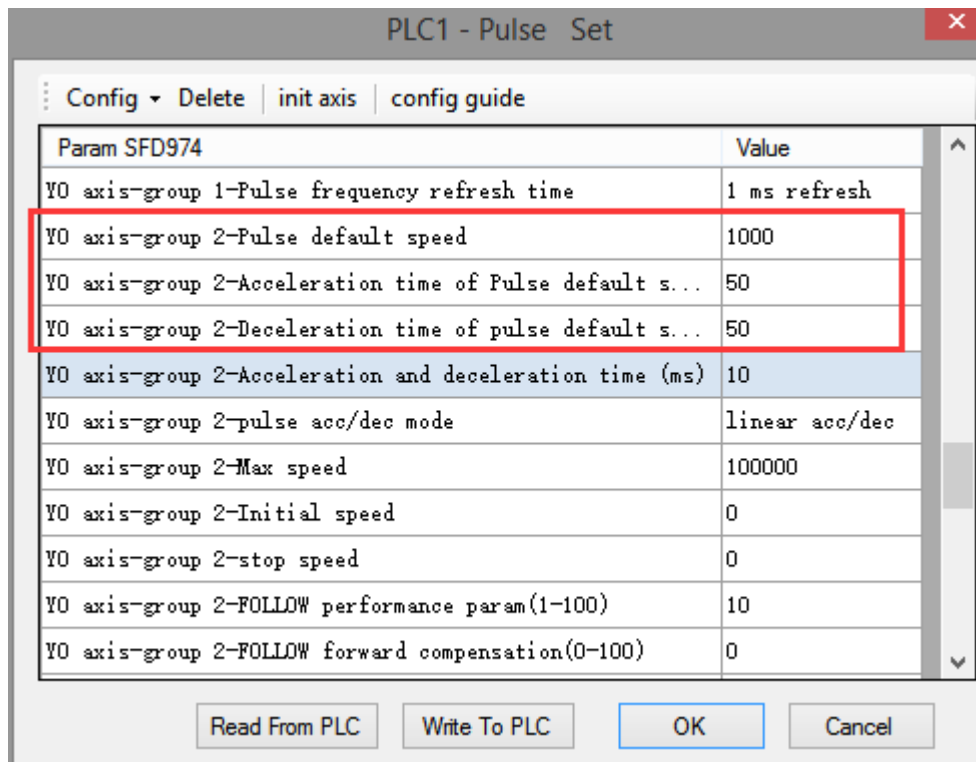

Axis Y0 system parameters (2)

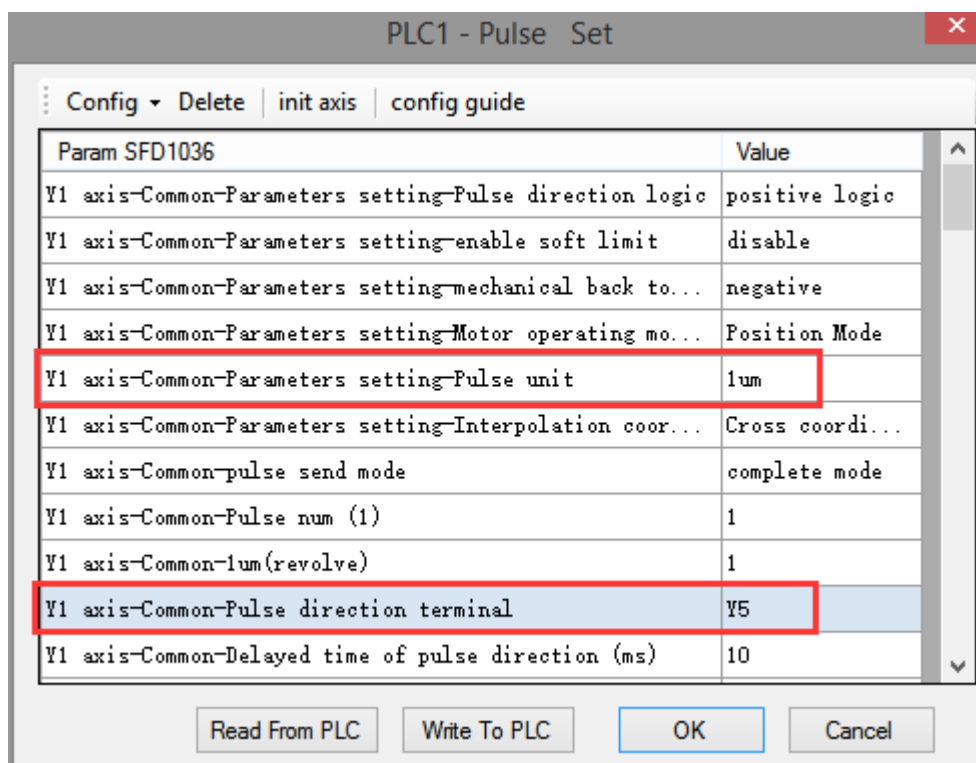

Axis Y1 system parameters

- As shown in the figure, D0 specifies the final position of axis 1 and D10 specifies the final position of axis 2, D20 specifies the radius, D30 specifies the start speed, D40 specifies the stop speed, D50 specifies the max speed.

- Y0 is the pulse output port of axis 1 and Y1 is the pulse output port of axis 2. See Sections 2-3 for other optional ports.
  - The directional terminals are Y4 and Y5, it is ON for the forward pulse and OFF for the reverse pulse.
  - Pulse frequency range: 1Hz ~ 100KHz; Acceleration and deceleration time: 0 ~ 65535ms.
  - Location movement can be viewed in equivalent cumulative registers HSD2 and HSD6.
  - Assuming HSD2 = 1000, HSD6 = 1000, D0 = 5000, D10 = 2000, D40 = 50Hz, D50 = 20, D60 = 2000, when M0 rises, execute CW\_R command, accelerate from the starting position (1000,1000) at speed 50Hz to the maximum speed (2000Hz), and stop at the end speed of 20Hz when moving to the target position.
- (1) When the end point is in absolute mode, the target position is (5000,2000)
- (2) When the end point is in the relative mode, the target position is (6000,3000)
- When the CW\_R instruction is running, the pulse flag bit corresponding to its output port Y will be set on.
  - The completion of the interpolation instruction can be judged by BLOCK executing flag bit. For example, the flag bit of BLOCK1 is SM300, when SM300 changes from ON to OFF, it means that BLOCK1 has finished executing.
  - When the radius is positive, the arc is inferior; when the radius is negative, it is major arc.

Note: In this mode, the starting speed (S3), the ending speed (S4) and the maximum speed (S5) are all expressed as the two-axis synthesis speed, as shown in the following figure:

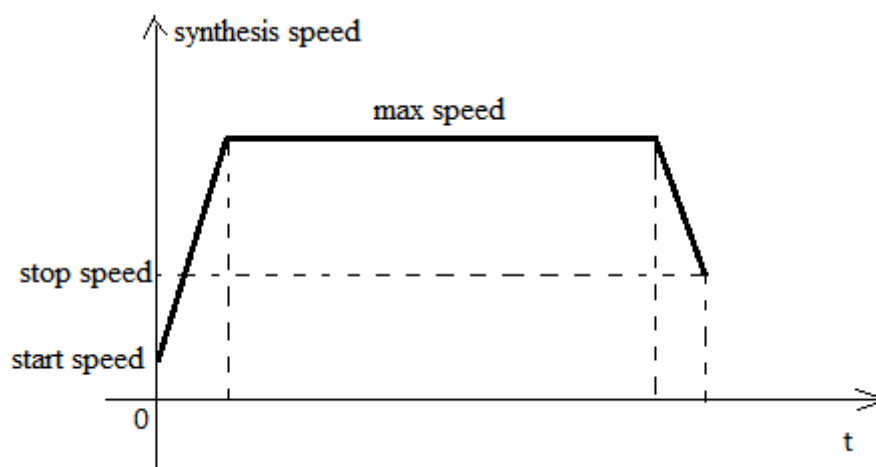

When there are multiple continuous linear/arc interpolation instructions and the speed between them needs to be constant and jump directly, the termination speed and maximum speed of the previous linear/arc interpolation can be set the same as the starting speed and maximum speed of the next segment.

When mode 3 is used, the starting and ending speed in the pulse parameter configuration tables of axis 1 and axis 2 are only effective for calculating the slope of pulse acceleration and deceleration.

### 2-4-7. Anticlockwise arc [CCW\_R]

Anticlockwise arc interpolation CCW\_R is mainly based on the current position of the arc, the target position and the length of the radius of the circle, clockwise to determine a section of the arc, as shown in the following figure:

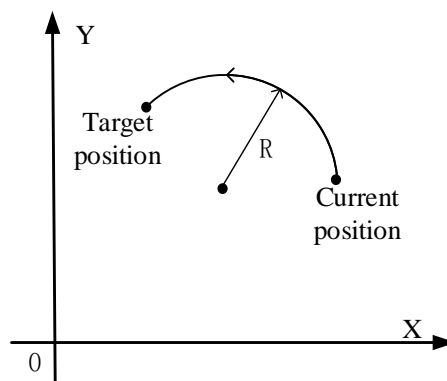

With the above figure, when the target position is set at the same position as the current one, the next circle can not be determined, so this mode can not draw a whole circle. There are three modes of CCW\_R. The usage of CCW\_R is described below.

#### Mode 1: CCW\_R anticlockwise arc

##### 1. Instruction overview

Anticlockwise arc interpolation instruction, operate according to the set default speed. This instruction can only be used in BLOCK. See Section 2-2 for specific usage.

Anticlockwise arc interpolation [CCW_R]			
16-bit instruction	-	32-bit instruction	CCW_R
Execution condition	Rise/fall edge of coil	Suitable model	XDM, XDME, XLME, XDH
Firmware	V3.3 and above	Software	V3.3 and above

##### 2. Operand

Operand	Function	Type
S0	Axis 1 target position	Double words, 32-bit
S1	Axis 2 target position	Double words, 32-bit
S2	Specify the radius of the arc	Double words, 32-bit
D0	Pulse output port of axis 1	Bit
D1	Pulse output port of axis 2	Bit

## 3. Suitable soft component

Word	Operand	System								Constant	Module	
		D*	FD	TD*	CD*	DX	DY	DM*	DS*	K/H	ID	QD
S0		•	•	•	•							
S1		•	•	•	•							
S2		•	•	•	•							

Bit	Operand	System						
		X	Y	M*	S*	T*	C*	Dnm
D0			•					
D1			•					

\* Note: D denotes D HD; TD denotes TD HTD; CD denotes CD HCD HSCD HSD; DM denotes DM DHM; DS denotes DS DHS; M denotes M HM SM; S denotes S HS; T denotes T HT; C denotes C HC.

## 4. Parameter setting

Related parameters	Setting	Note
Final position	Determine the end point position according to relative/absolute mode	Must set
Relative/absolute	Relative: the above position as a reference; absolute: the origin as a reference	Must set
Radius	The path of an arc varies with its radius.	Must set
Pulse output port of axis 1	Arbitrary specify pulse output point	Must set
Pulse output port of axis 2	Arbitrary specify pulse output point	Must set
Direction port of axis 1	Arbitrarily specify idle output points, set in system parameters	Must set
Direction port of axis 2	Arbitrarily specify idle output points, set in system parameters	Must set
Pulse unit	The pulse number or equivalent are acceptable. Set in axis 1 system parameters	Must set
Default speed	set in axis 1 group 2 parameters	Must set
Acceleration time	Set in axis 1 group 2 parameters	No need to set
Deceleration time	Set in axis 1 group 2 parameters	No need to set

## Function and action

《Instruction format》

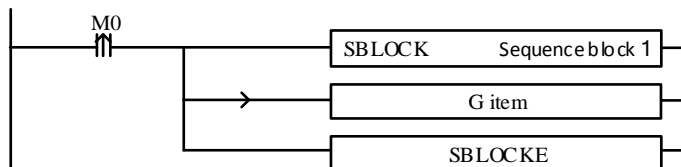

When the CCW\_R instruction of arc interpolation (mode 1) is executed, the two axes will run at the highest synthesis speed. As shown in the following figure:

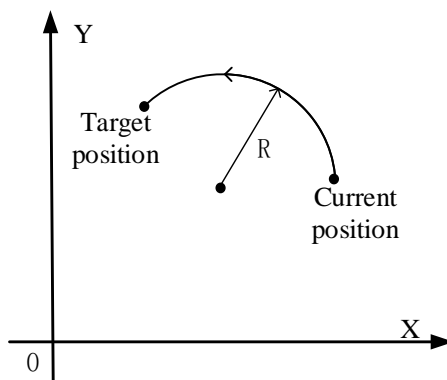

CCW\_R anticlockwise arc interpolation

The parameter configuration is shown in the following figure:

Double-click G item and pop up the configuration panel. Set it as follows:

	Params	Register	Absolute
▶	<b>S0</b> final position	D0	Absolute
	<b>S1</b> final position	D10	Absolute
	<b>S2</b> radius	D20	
	<b>D0</b> axis 1	Y0	params
	<b>D1</b> axis 2	Y1	params

Instruction configuration



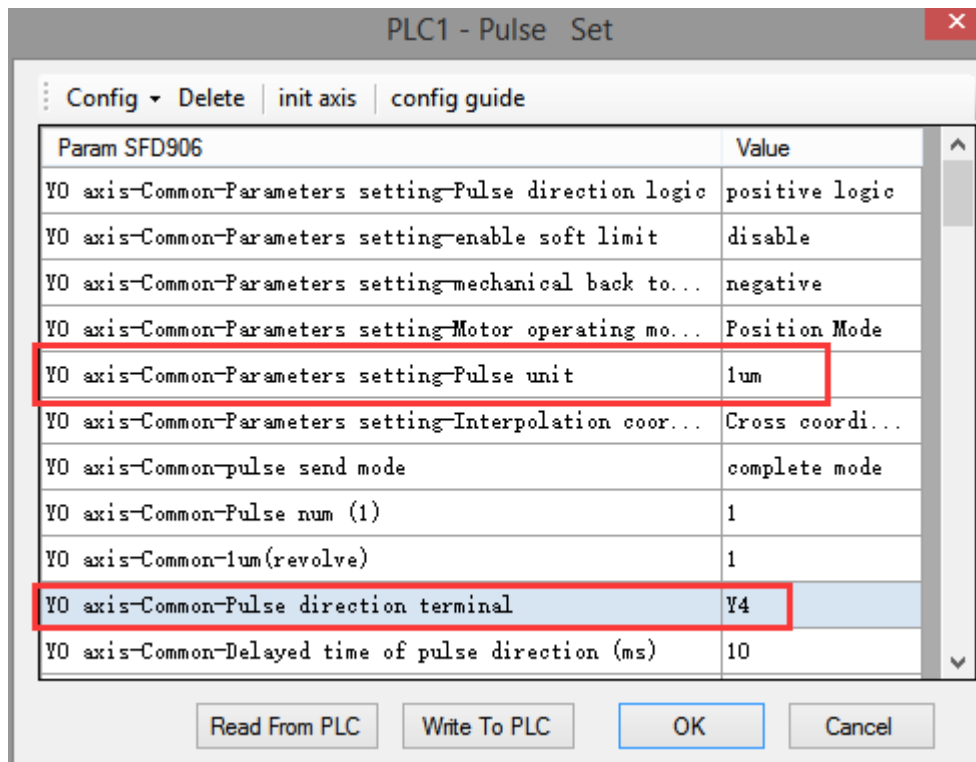

Axis Y0 system parameters (1)

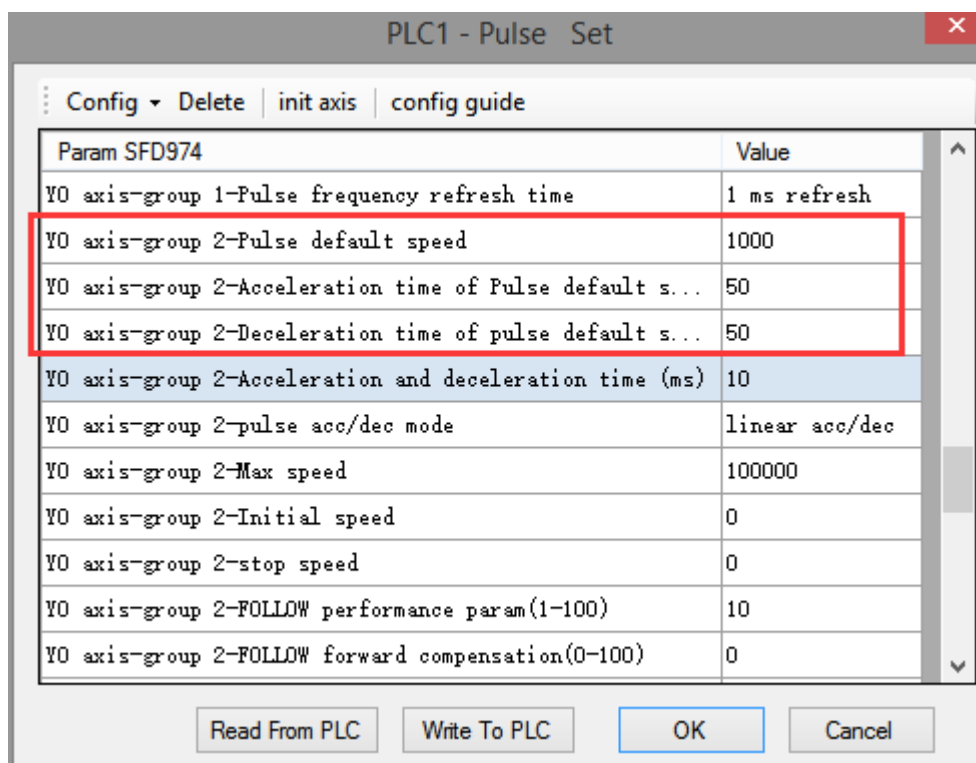

Axis Y0 system parameters (2)

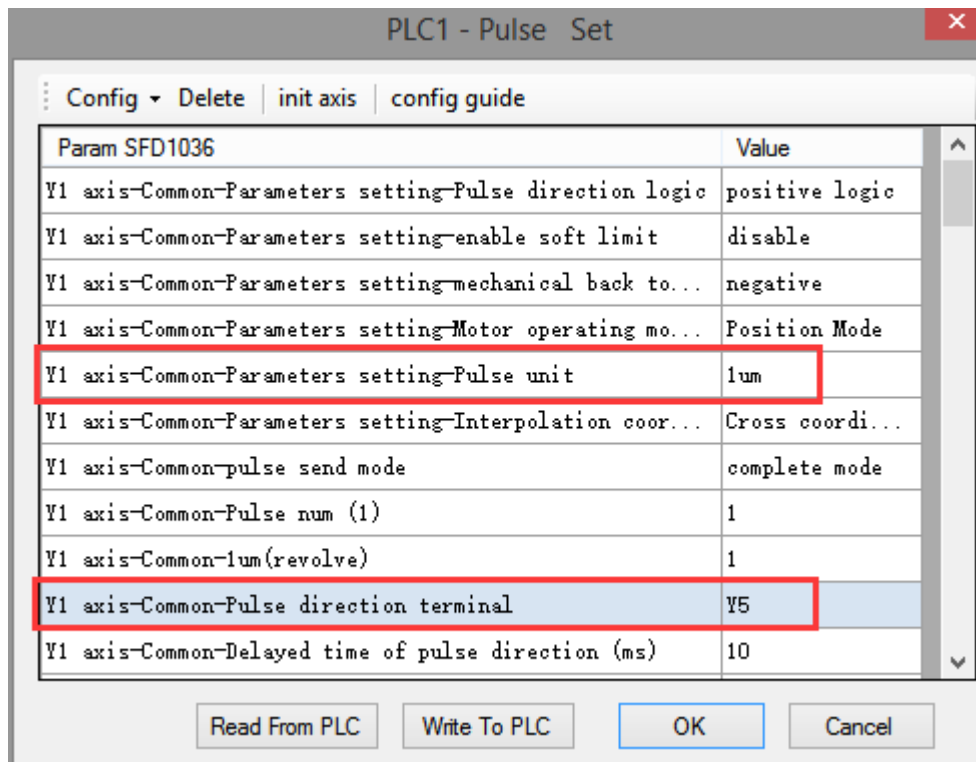

Axis Y1 system parameters

- As shown in the figure, D0 specifies the final position of axis 1 and D10 specifies the final position of axis 2, D20 specifies the circle radius.
  - Y0 is the pulse output port of axis 1 and Y1 is the pulse output port of axis 2. See Sections 2-3 for other optional ports.
  - The directional terminals are Y4 and Y5, it is ON for the forward pulse and OFF for the reverse pulse.
  - Pulse frequency range: 1Hz ~ 100KHz; Acceleration and deceleration time: 0 ~ 65535ms.
  - Location movement can be viewed in equivalent cumulative registers HSD2 and HSD6.
  - Assuming HSD2 = 1000, HSD6 = 1000, D0 = 5000, D10 = 2000, when M0 rises, execute CCW\_R command, move from the starting position (1000, 1000) to the target position at the default speed of 1000Hz.
- (1) When the end point is in absolute mode, the target position is (5000,2000)
  - (2) When the end point is in the relative mode, the target position is (6000,3000)
- When the CCW\_R instruction is running, the pulse flag bit corresponding to its output port Y will be set on.
  - The completion of the interpolation instruction can be judged by BLOCK executing flag bit. For example, the flag bit of BLOCK1 is SM300, when SM300 changes from ON to OFF, it means that BLOCK1 has finished executing.
  - When the radius is positive, the arc is inferior; when the radius is negative, it is major arc.

### Mode 2: CCW\_R anticlockwise arc VM

#### 1. Instruction overview

Anticlockwise arc interpolation instruction, operate according to the set maximum synthetic speed. This instruction can only be used in BLOCK. See Section 2-2 for specific usage.

Anticlockwise arc interpolation [CCW_R]			
16-bit instruction	-	32-bit instruction	CCW_R
Execution condition	Rise/fall edge of coil	Suitable model	XDM, XDME, XLME, XDH
Firmware	V3.3 and above	Software	V3.3 and above

#### 2. Operand

Operand	Function	Type
S0	Axis 1 target position	Double words, 32-bit
S1	Axis 2 target position	Double words, 32-bit
S2	Specify the radius of the arc	Double words, 32-bit
S3	Max speed of the two axes	Double words, 32-bit
D0	Pulse output port of axis 1	Bit
D1	Pulse output port of axis 2	Bit

#### 3. Suitable soft component

Word	Operand	System								Constant	Module	
		D*	FD	TD*	CD*	DX	DY	DM*	DS*	K/H	ID	QD
	S0	•	•	•	•							
	S1	•	•	•	•							
	S2	•	•	•	•							
S3	•	•	•	•								
Bit	Operand	System										
		X	Y	M*	S*	T*	C*	Dnm				
	D0		•									
D1		•										

\* Note: D denotes D HD; TD denotes TD HTD; CD denotes CD HCD HSCD HSD; DM denotes DM DHM; DS denotes DS DHS; M denotes M HM SM; S denotes S HS; T denotes T HT; C denotes C HC.

#### 4. Parameter setting

Related parameters	Setting	Note
Final position	Determine the end point position according to relative/absolute mode	Must set

Relative/absolute	Relative: the above position as a reference; absolute: the origin as a reference	Must set
Radius	The path of an arc varies with its radius.	Must set
Max speed	Specify maximum smooth running speed of two axes	Must set
Pulse output port of axis 1	Arbitrary specify pulse output point	Must set
Pulse output port of axis 2	Arbitrary specify pulse output point	Must set
Direction port of axis 1	Arbitrarily specify idle output points, set in system parameters	Must set
Direction port of axis 2	Arbitrarily specify idle output points, set in system parameters	Must set
Pulse unit	The pulse number or equivalent are acceptable. Set in axis 1 system parameters	Must set
Default speed	set in axis 1 group 2 parameters	No need to set
Acceleration time	Set in axis 1 group 2 parameters	No need to set
Deceleration time	Set in axis 1 group 2 parameters	No need to set

**Function and action**

《Instruction format》

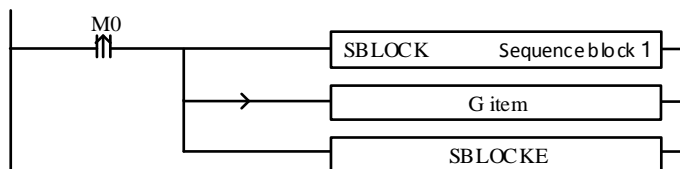

When the CCW\_R instruction of arc interpolation (mode 2) is executed, the two axes will run at the set max synthesis speed. As shown in the following figure:

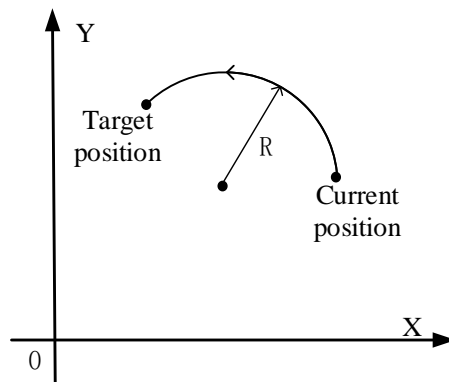

**CCW\_R anticlockwise arc interpolation**

The parameter configuration is shown in the following figure:

Double-click G item and pop up the configuration panel. Set it as follows:

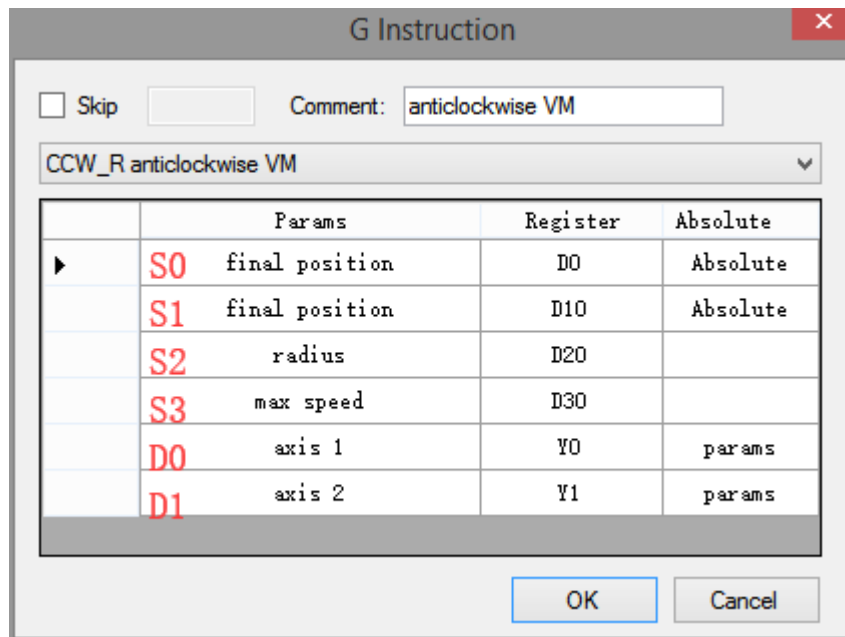

Instruction configuration

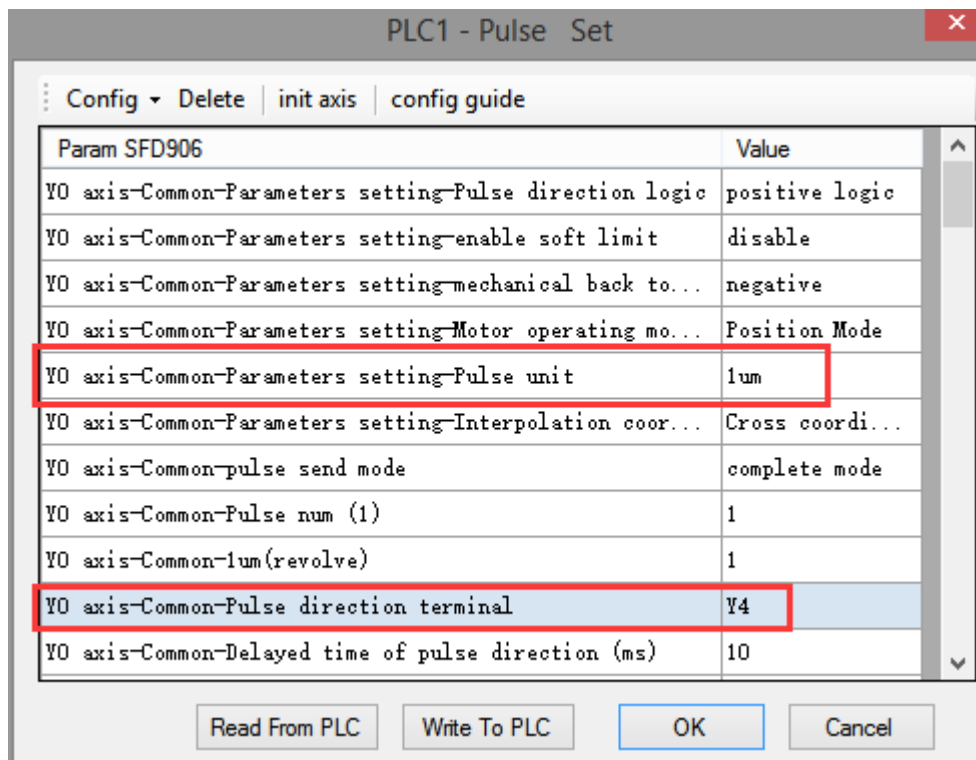

Axis Y0 system parameters (1)

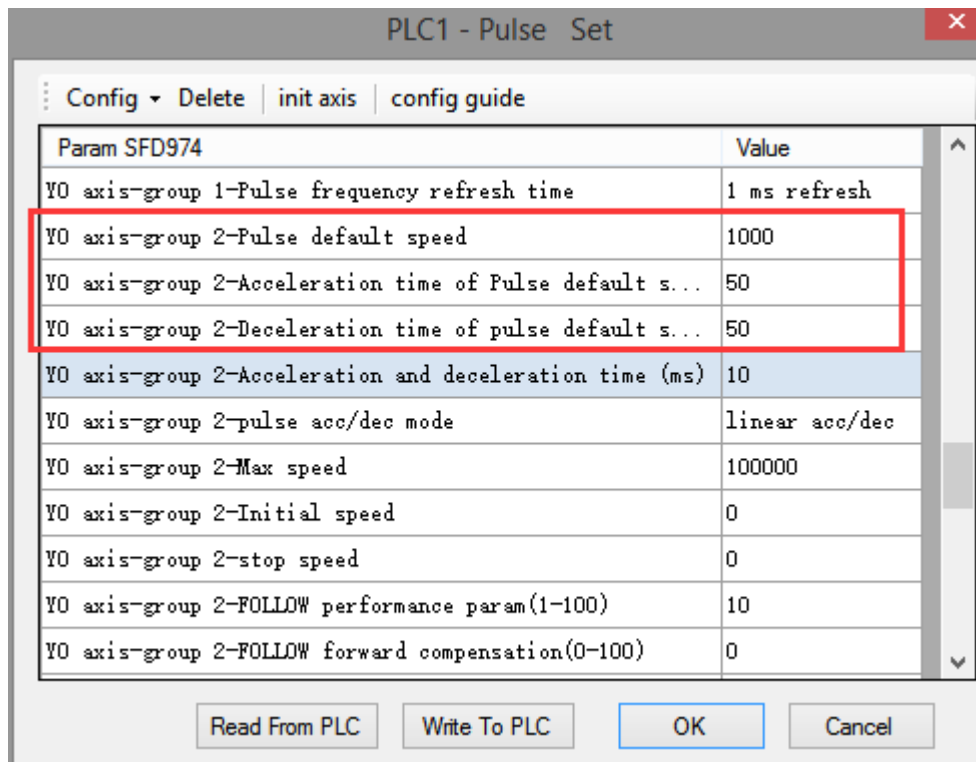

Axis Y0 system parameters (2)

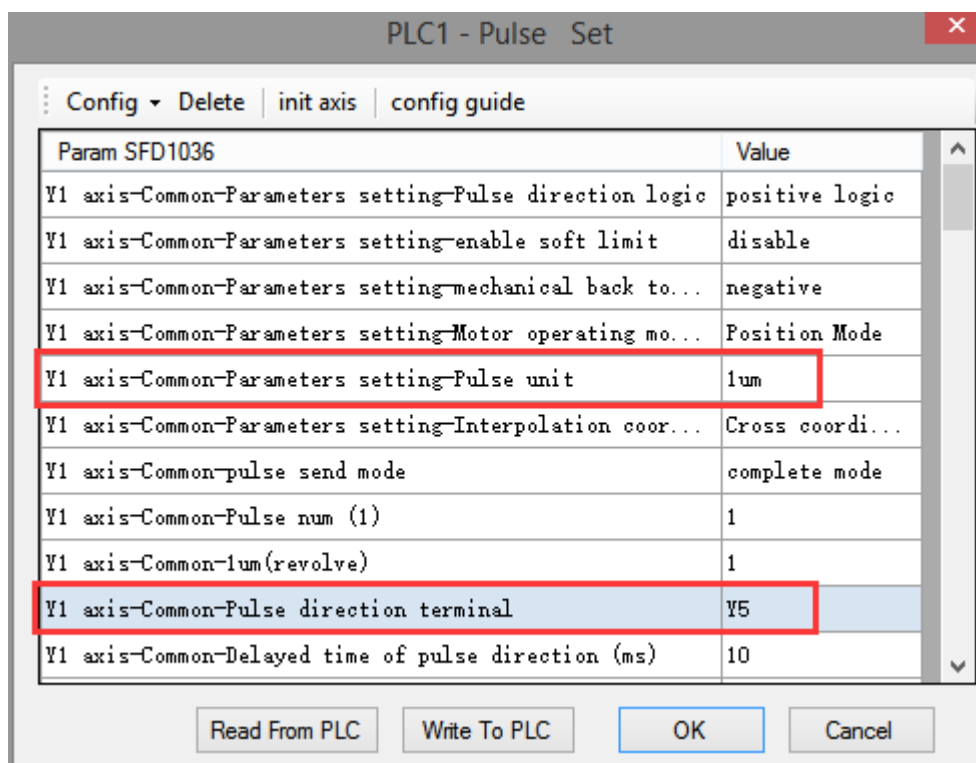

Axis Y1 system parameters

- As shown in the figure, D0 specifies the final position of axis 1 and D10 specifies the final position of axis 2, D20 specifies the radius (the radius is different and the path is different), D30 specifies the max speed.

- Y0 is the pulse output port of axis 1 and Y1 is the pulse output port of axis 2. See Sections 2-3 for other optional ports.
  - The directional terminals are Y4 and Y5, it is ON for the forward pulse and OFF for the reverse pulse.
  - Pulse frequency range: 1Hz ~ 100KHz; Acceleration and deceleration time: 0 ~ 65535ms.
  - Location movement can be viewed in equivalent cumulative registers HSD2 and HSD6.
  - Assuming HSD2 = 1000, HSD6 = 1000, D0 = 5000, D10 = 2000, D30 = 500Hz, when M0 rises, execute CCW\_R command, move from the starting position (1000, 1000) to the target position at the max speed of 500Hz.
- (1) When the end point is in absolute mode, the target position is (5000,2000)
- (2) When the end point is in the relative mode, the target position is (6000,3000)
- When the CCW\_R instruction is running, the pulse flag bit corresponding to its output port Y will be set on.
  - The completion of the interpolation instruction can be judged by BLOCK executing flag bit. For example, the flag bit of BLOCK1 is SM300, when SM300 changes from ON to OFF, it means that BLOCK1 has finished executing.
  - When the radius is positive, the arc is inferior; when the radius is negative, it is major arc.

### Mode 3: CCW\_R anticlockwise arc VBEM

#### 1. Instruction overview

Anticlockwise arc interpolation instruction, operate according to the set maximum synthetic speed, start speed and stop speed. This instruction can only be used in BLOCK. See Section 2-2 for specific usage.

Anticlockwise arc interpolation [CCW_R]			
16-bit instruction	-	32-bit instruction	CCW_R
Execution condition	Rise/fall edge of coil	Suitable model	XDM, XDME, XLME, XDH
Firmware	V3.3 and above	Software	V3.3 and above

#### 2. Operand

Operand	Function	Type
S0	Axis 1 target position	Double words, 32-bit
S1	Axis 2 target position	Double words, 32-bit
S2	Specify the radius of the arc	Double words, 32-bit
S3	Specify the starting speed at the starting point of the two axes	Double words, 32-bit
S4	Specify the stop speed at the end point of the two axes	Double words, 32-bit
S5	Max speed of the two axes	Double words, 32-bit

D0	Pulse output port of axis 1	Bit
D1	Pulse output port of axis 2	Bit

## 3. Suitable soft component

Word	Operand	System							Constant	Module	
		D*	FD	TD*	CD*	DX	DY	DM*	DS*	K/H	ID
	S0~S5	•	•	•	•						
Bit	Operand	System									
		X	Y	M*	S*	T*	C*	Dnm			
	D0		•								
	D1		•								

\* Note: D denotes D HD; TD denotes TD HTD; CD denotes CD HCD HSCD HSD; DM denotes DM DHM; DS denotes DS DHS; M denotes M HM SM; S denotes S HS; T denotes T HT; C denotes C HC.

## 4. Parameter setting

Related parameters	Setting	Note
Final position	Determine the end point position according to relative/absolute mode	Must set
Relative/absolute	Relative: the above position as a reference; absolute: the origin as a reference	Must set
radius	The radius is different and the path is different	Must set
Max speed	Specify maximum smooth running speed of two axes	Must set
Start speed	The start speed from the starting point	Must set
Stop speed	The stop speed at the end point	Must set
Pulse output port of axis 1	Arbitrary specify pulse output point	Must set
Pulse output port of axis 2	Arbitrary specify pulse output point	Must set
Direction port of axis 1	Arbitrarily specify idle output points, set in system parameters	Must set
Direction port of axis 2	Arbitrarily specify idle output points, set in system parameters	Must set
Pulse unit	The pulse number or equivalent are acceptable. Set in axis 1 system parameters	Must set
Default speed	set in axis 1 group 2 parameters	No need to set
Acceleration time	Set in axis 1 group 2 parameters	No need to set
Deceleration time	Set in axis 1 group 2 parameters	No need to set



### Function and action

«Instruction format»

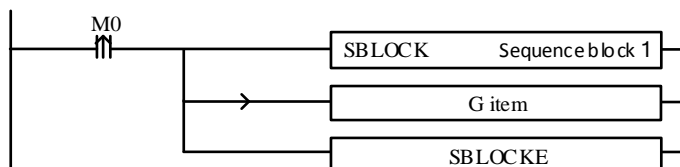

When the CCW\_R instruction of arc interpolation (mode 3) is executed, the two axes will run at the set max synthesis speed, start speed and stop speed. As shown in the following figure:

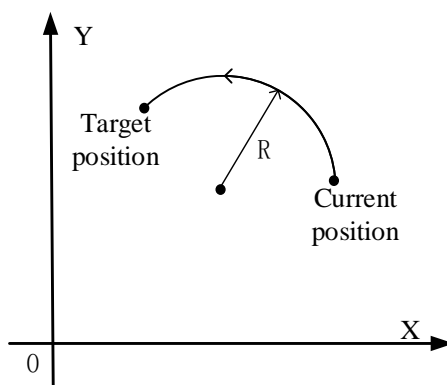

CCW\_R anticlockwise arc interpolation

The parameter configuration is shown in the following figure:

Double-click G item and pop up the configuration panel. Set it as follows:

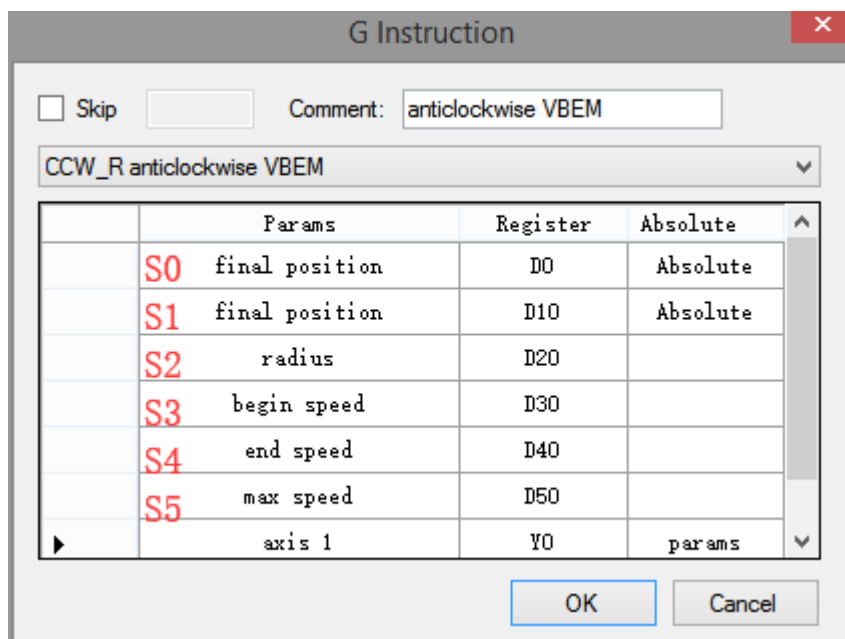

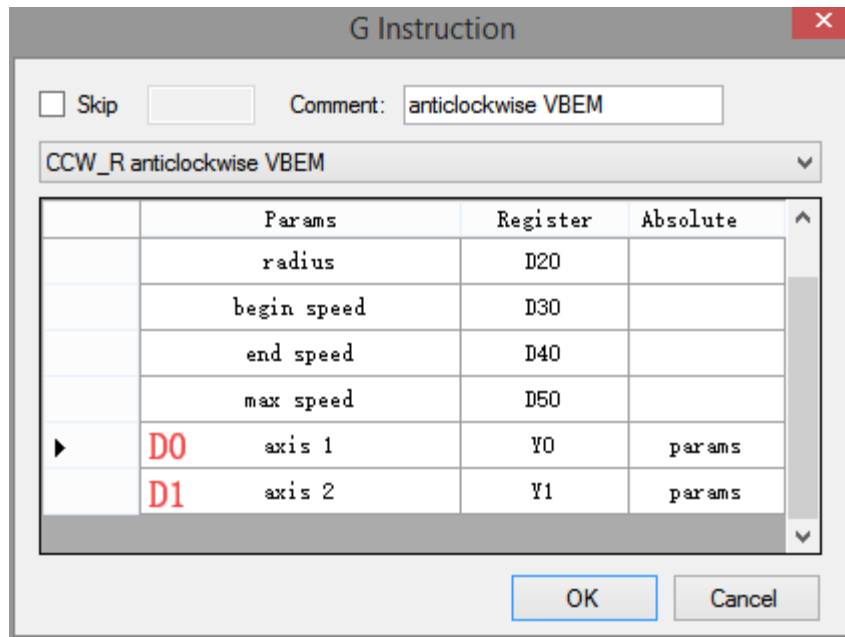

Instruction configuration

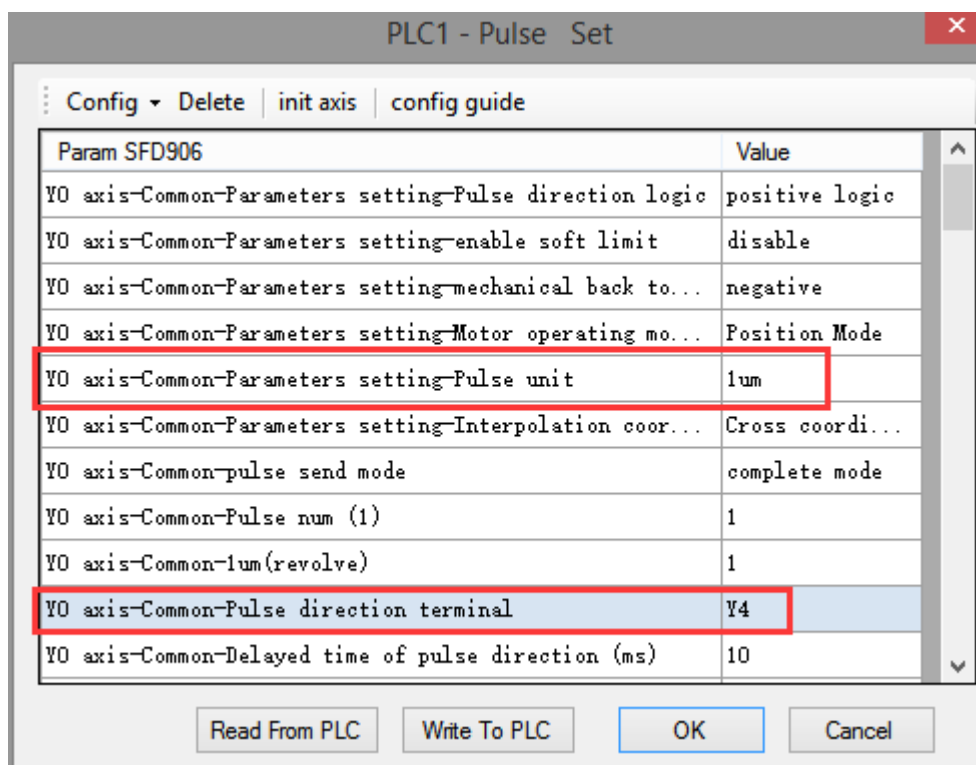

Axis Y0 system parameters (1)

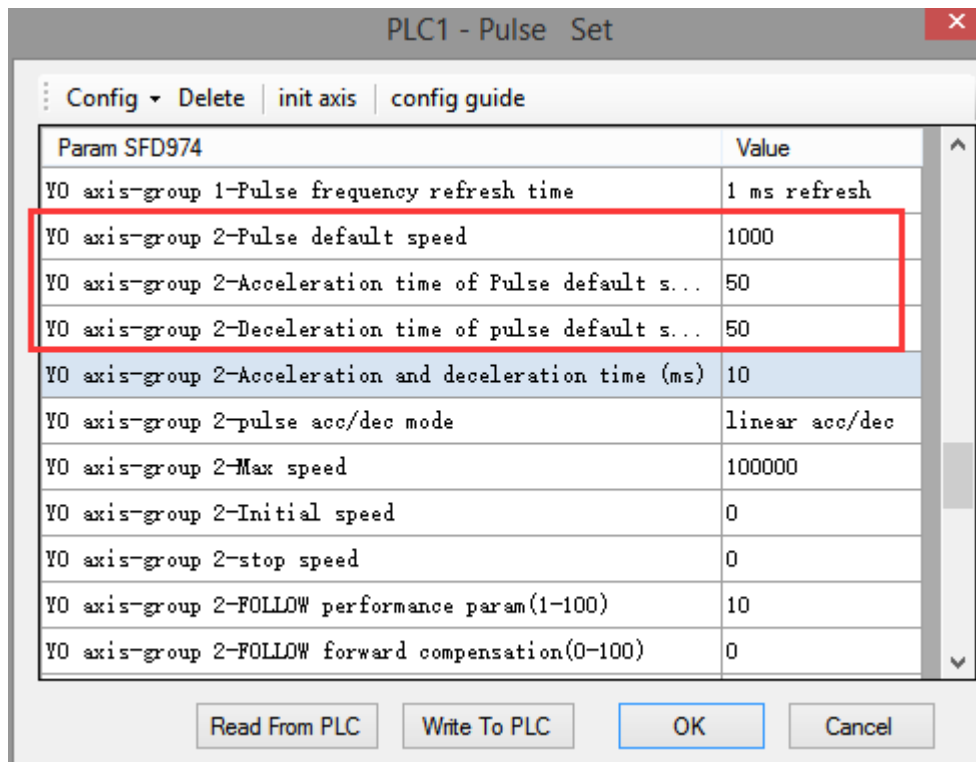

Axis Y0 system parameters (2)

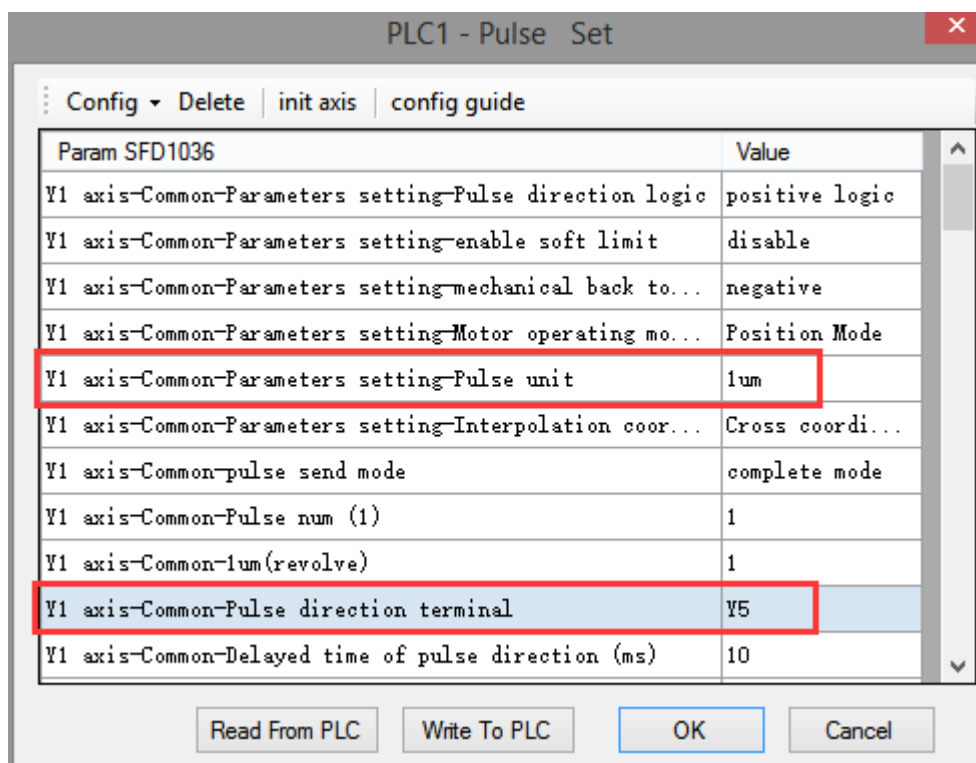

Axis Y1 system parameters

- As shown in the figure, D0 specifies the final position of axis 1 and D10 specifies the final position of axis 2, D20 specifies the radius, D30 specifies the start speed, D40 specifies the stop speed, D50 specifies the max speed.

- Y0 is the pulse output port of axis 1 and Y1 is the pulse output port of axis 2. See Sections 2-3 for other optional ports.
  - The directional terminals are Y4 and Y5, it is ON for the forward pulse and OFF for the reverse pulse.
  - Pulse frequency range: 1Hz ~ 100KHz; Acceleration and deceleration time: 0 ~ 65535ms.
  - Location movement can be viewed in equivalent cumulative registers HSD2 and HSD6.
  - Assuming HSD2 = 1000, HSD6 = 1000, D0 = 5000, D10 = 2000, D30 = 50Hz, D40 = 20, D50 = 2000, when M0 rises, execute CCW\_R command, accelerate from the starting position (1000,1000) at speed 50Hz to the maximum speed (2000Hz), and stop at the end speed of 20Hz when moving to the target position.
- (1) When the end point is in absolute mode, the target position is (5000,2000)  
 (2) When the end point is in the relative mode, the target position is (6000,3000)
- When the CCW\_R instruction is running, the pulse flag bit corresponding to its output port Y will be set on.
  - The completion of the interpolation instruction can be judged by BLOCK executing flag bit. For example, the flag bit of BLOCK1 is SM300, when SM300 changes from ON to OFF, it means that BLOCK1 has finished executing.
  - When the radius is positive, the arc is inferior; when the radius is negative, it is major arc.

Note: In this mode, the starting speed (S3), the ending speed (S4) and the maximum speed (S5) are all expressed as the two-axis synthesis speed, as shown in the following figure:

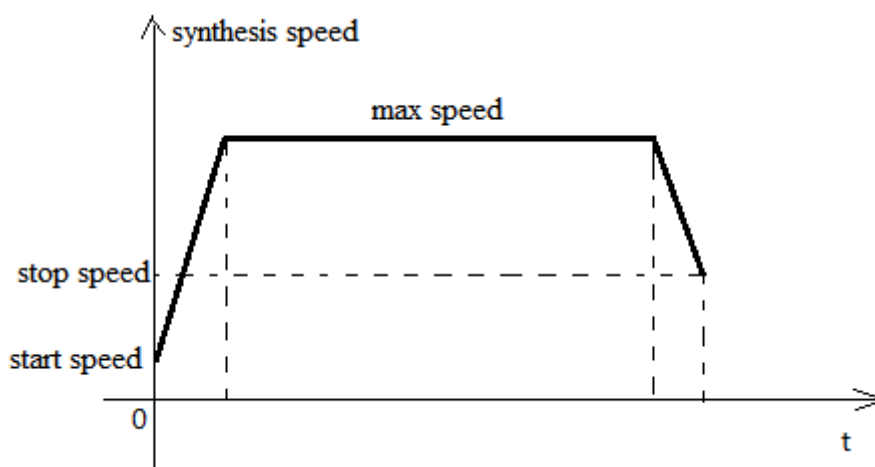

When there are multiple continuous linear/arc interpolation instructions and the speed between them needs to be constant and jump directly, the termination speed and maximum speed of the previous linear/arc interpolation can be set the same as the starting speed and maximum speed of the next segment.

When mode 3 is used, the starting and ending speed in the pulse parameter configuration tables of axis 1 and axis 2 are only effective for calculating the slope of pulse acceleration and deceleration.

### 2-4-8. Three points arc [ARC]

Three-point arc interpolation ARC mainly determines a section of arc clockwise or counter-clockwise through the current position of the arc, the target position and a midpoint position on the arc.

Note: The midpoint position on the arc refers to any point position between the current position and the target position on the drawn arc. As shown in the following figure:

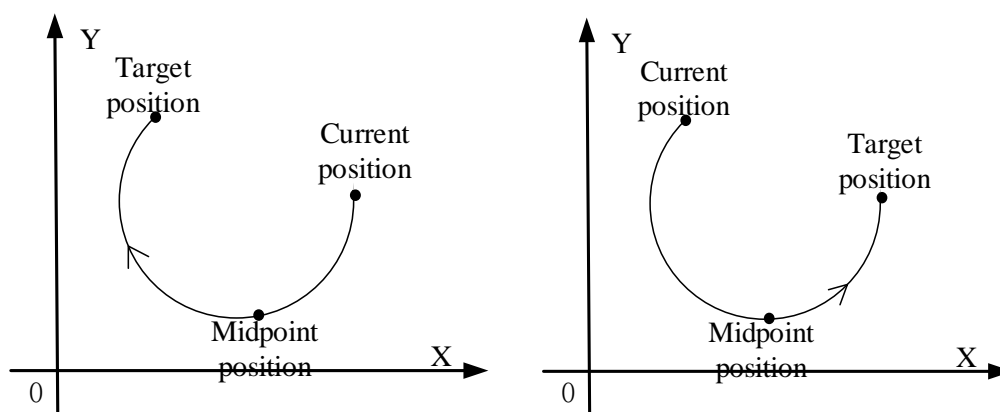

When the target position is set to the same position as the current position (that is, two points become a point), the next circle can not be determined by two points (in three points, as long as two points coincide or three points are in a straight line, it can not form an arc), so this mode can not draw a whole circle. Three-point arc interpolation ARC has three modes, the following will be used one by one.

#### Mode 1: ARC three-point arc

##### 1. Instruction overview

Three-point arc interpolation instruction, operate according to the set default speed. This instruction can only be used in BLOCK. See Section 2-2 for specific usage.

Three-point arc interpolation [ARC]			
16-bit instruction	-	32-bit instruction	ARC
Execution condition	Rise/fall edge of coil	Suitable model	XDM, XDME, XLME, XDH
Firmware	V3.3 and above	Software	V3.3 and above

##### 2. Operand

Operand	Function	Type
S0	Axis 1 target position	Double words, 32-bit
S1	Axis 2 target position	Double words, 32-bit
S2	Axis 1 midpoint position	Double words, 32-bit
S3	Axis 2 midpoint position	Double words, 32-bit
D0	Pulse output port of axis 1	Bit

D1	Pulse output port of axis 2	Bit
----	-----------------------------	-----

## 3. Suitable soft component

Word	Operand	System								Constant	Module	
		D*	FD	TD*	CD*	DX	DY	DM*	DS*	K/H	ID	QD
	S0	•	•	•	•							
	S1	•	•	•	•							
	S2	•	•	•	•							
S3	•	•	•	•								
Bit	Operand	System										
		X	Y	M*	S*	T*	C*	Dnm				
	D0		•									
	D1		•									

\* Note: D denotes D HD; TD denotes TD HTD; CD denotes CD HCD HSCD HSD; DM denotes DM DHM; DS denotes DS DHS; M denotes M HM SM; S denotes S HS; T denotes T HT; C denotes C HC.

## 4. Parameter setting

Related parameters	Setting	Note
Final position	Determine the end point position according to relative/absolute mode	Must set
Relative/absolute	Relative: the above position as a reference; absolute: the origin as a reference	Must set
Midpoint position	Determining the position of the midpoint of an arc according to its path	Must set
Pulse output port of axis 1	Arbitrary specify pulse output point	Must set
Pulse output port of axis 2	Arbitrary specify pulse output point	Must set
Direction port of axis 1	Arbitrarily specify idle output points, set in system parameters	Must set
Direction port of axis 2	Arbitrarily specify idle output points, set in system parameters	Must set
Pulse unit	The pulse number or equivalent are acceptable. Set in axis 1 system parameters	Must set
Default speed	set in axis 1 group 2 parameters	Must set
Acceleration time	Set in axis 1 group 2 parameters	No need to set
Deceleration time	Set in axis 1 group 2 parameters	No need to set

**Function and action**

《Instruction format》

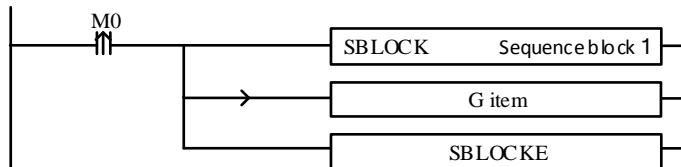

When the ARC instruction of arc interpolation (mode 1) is executed, the two axes will run at the highest synthesis speed. As shown in the following figure:

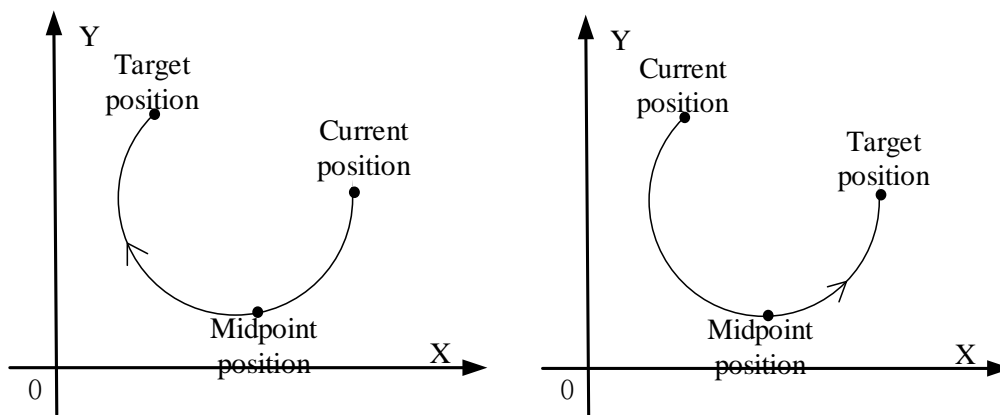

**ARC arc interpolation**

The parameter configuration is shown in the following figure:

Double-click G item and pop up the configuration panel. Set it as follows:

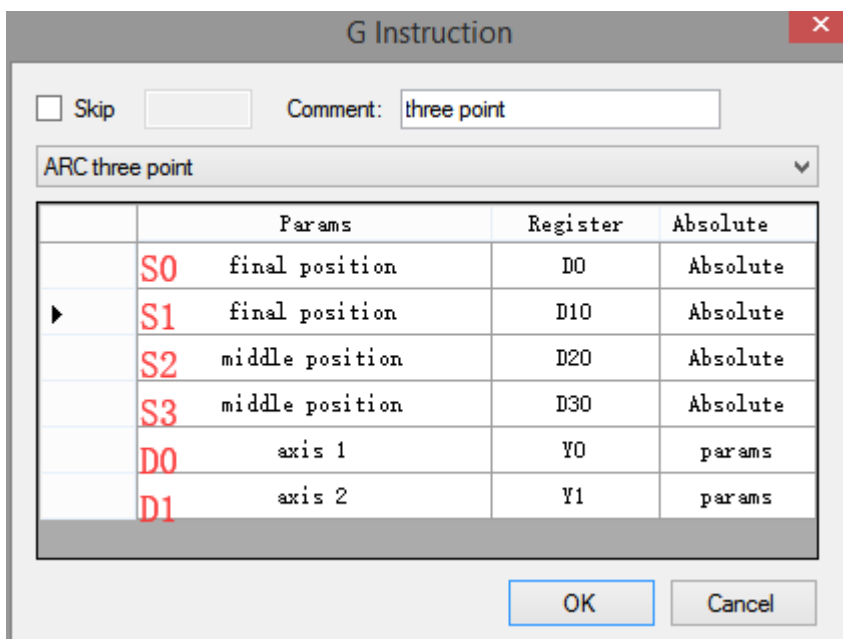

## Instruction configuration

PLC1 - Pulse Set

Config ▾ Delete | init axis | config guide

Param SFD906	Value
Y0 axis-Common-Parameters setting-Pulse direction logic	positive logic
Y0 axis-Common-Parameters setting-enable soft limit	disable
Y0 axis-Common-Parameters setting-mechanical back to...	negative
Y0 axis-Common-Parameters setting-Motor operating mo...	Position Mode
Y0 axis-Common-Parameters setting-Pulse unit	1um
Y0 axis-Common-Parameters setting-Interpolation coor...	Cross coordi...
Y0 axis-Common-pulse send mode	complete mode
Y0 axis-Common-Pulse num (1)	1
Y0 axis-Common-1um(revolve)	1
Y0 axis-Common-Pulse direction terminal	Y4
Y0 axis-Common-Delayed time of pulse direction (ms)	10

Read From PLC Write To PLC OK Cancel

Axis Y0 system parameters (1)

PLC1 - Pulse Set

Config ▾ Delete | init axis | config guide

Param SFD974	Value
Y0 axis-group 1-Pulse frequency refresh time	1 ms refresh
Y0 axis-group 2-Pulse default speed	1000
Y0 axis-group 2-Acceleration time of Pulse default s...	50
Y0 axis-group 2-Deceleration time of pulse default s...	50
Y0 axis-group 2-Acceleration and deceleration time (ms)	10
Y0 axis-group 2-pulse acc/dec mode	linear acc/dec
Y0 axis-group 2-Max speed	100000
Y0 axis-group 2-Initial speed	0
Y0 axis-group 2-stop speed	0
Y0 axis-group 2-FOLLOW performance param(1-100)	10
Y0 axis-group 2-FOLLOW forward compensation(0-100)	0

Read From PLC Write To PLC OK Cancel

Axis Y0 system parameters (2)



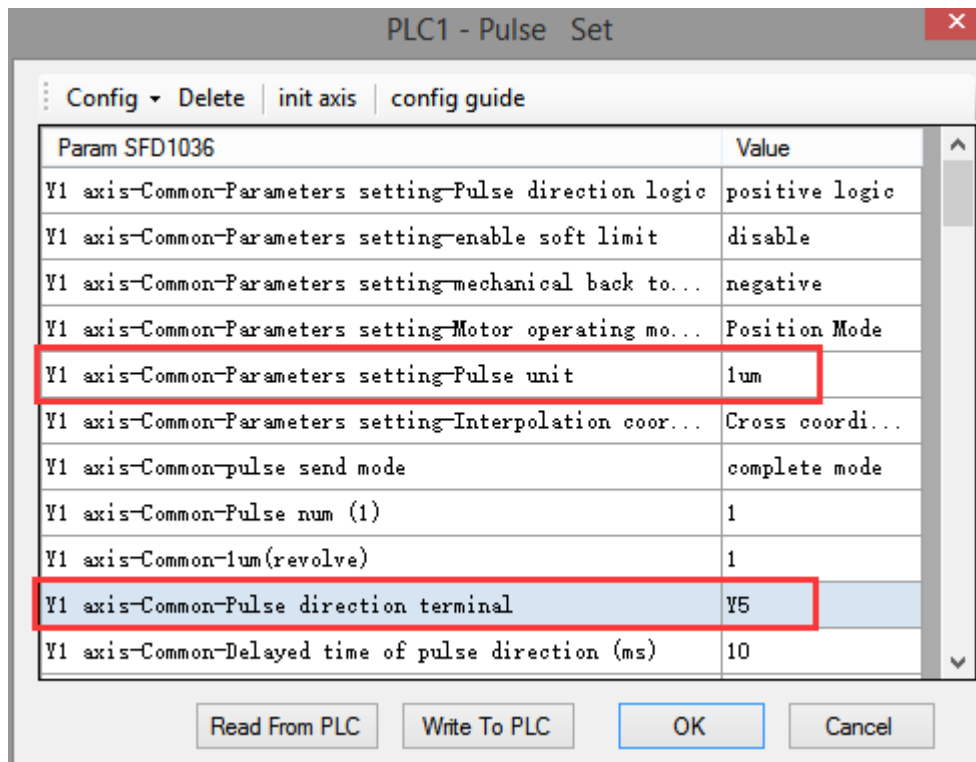

Axis Y1 system parameters

- As shown in the figure, D0 specifies the final position of axis 1 and D10 specifies the final position of axis 2, D20 specifies the midpoint of axis 1 and D30 specifies the midpoint of axis 2.
- Y0 is the pulse output port of axis 1 and Y1 is the pulse output port of axis 2. See Sections 2-3 for other optional ports.
- The directional terminals are Y4 and Y5, it is ON for the forward pulse and OFF for the reverse pulse.
- Pulse frequency range: 1Hz ~ 100KHz; Acceleration and deceleration time: 0 ~ 65535ms.
- Location movement can be viewed in equivalent cumulative registers HSD2 and HSD6.
- Assuming HSD2 = 1000, HSD6 = 1000, D0 = 5000, D10 = 2000, when M0 rises, execute ARC command, move from the starting position (1000, 1000) to the target position at the default speed of 1000Hz.
  - (1) When the end point is in absolute mode, the target position is (5000,2000)
  - (2) When the end point is in the relative mode, the target position is (6000,3000)
- When the ARC instruction is running, the pulse flag bit corresponding to its output port Y will be set on.
- The completion of the interpolation instruction can be judged by BLOCK executing flag bit. For example, the flag bit of BLOCK1 is SM300, when SM300 changes from ON to OFF, it means that BLOCK1 has finished executing.

## Mode 2: ARC three-point arc VM

### 1. Instruction overview

Three-point arc interpolation instruction, operate according to the set maximum synthetic speed. This instruction can only be used in BLOCK. See Section 2-2 for specific usage.

Three-point arc interpolation [ARC]			
16-bit instruction	-	32-bit instruction	ARC
Execution condition	Rise/fall edge of coil	Suitable model	XDM, XDME, XLME, XDH
Firmware	V3.3 and above	Software	V3.3 and above

### 2. Operand

Operand	Function	Type
S0	Axis 1 target position	Double words, 32-bit
S1	Axis 2 target position	Double words, 32-bit
S2	Specify the midpoint of axis 1	Double words, 32-bit
S3	Specify the midpoint of axis 2	Double words, 32-bit
S4	Max speed of the two axes	Double words, 32-bit
D0	Pulse output port of axis 1	Bit
D1	Pulse output port of axis 2	Bit

### 3. Suitable soft component

Word	Operand	System								Constant	Module	
		D*	FD	TD*	CD*	DX	DY	DM*	DS*	K/H	ID	QD
	S0~S4	•	•	•	•							
Bit	Operand	System										
		X	Y	M*	S*	T*	C*	Dnm				
	D0		•									
	D1		•									

\* Note: D denotes D HD; TD denotes TD HTD; CD denotes CD HCD HSCD HSD; DM denotes DM DHM; DS denotes DS DHS; M denotes M HM SM; S denotes S HS; T denotes T HT; C denotes C HC.

### 4. Parameter setting

Related parameters	Setting	Note
Final position	Determine the end point position according to relative/absolute mode	Must set
Relative/absolute	Relative: the above position as a reference; absolute: the origin as a reference	Must set

Midpoint position	Determining the midpoint position according to the arc path	Must set
Max speed	Specify maximum smooth running speed of two axes	Must set
Pulse output port of axis 1	Arbitrary specify pulse output point	Must set
Pulse output port of axis 2	Arbitrary specify pulse output point	Must set
Direction port of axis 1	Arbitrarily specify idle output points, set in system parameters	Must set
Direction port of axis 2	Arbitrarily specify idle output points, set in system parameters	Must set
Pulse unit	The pulse number or equivalent are acceptable. Set in axis 1 system parameters	Must set
Default speed	set in axis 1 group 2 parameters	No need to set
Acceleration time	Set in axis 1 group 2 parameters	No need to set
Deceleration time	Set in axis 1 group 2 parameters	No need to set

**Function and action**

《Instruction format》

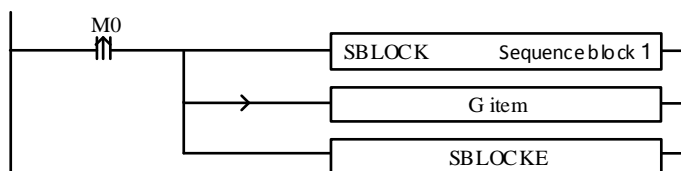

When the ARC instruction of arc interpolation (mode 2) is executed, the two axes will run at the set max synthesis speed. As shown in the following figure:

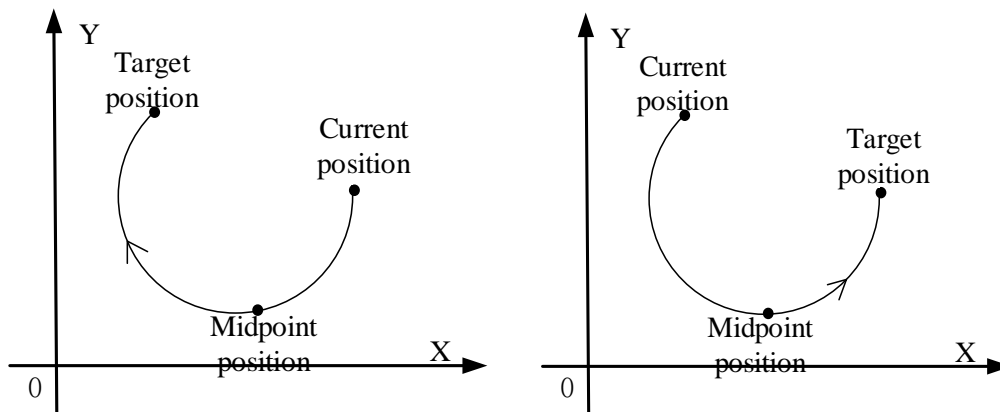

ARC arc interpolation

The parameter configuration is shown in the following figure:  
 Double-click G item and pop up the configuration panel. Set it as follows:

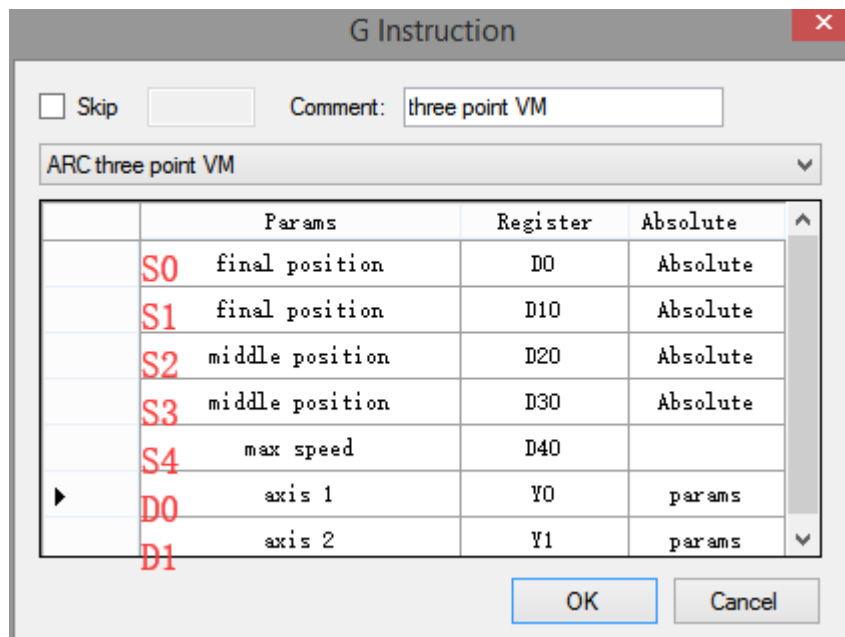

Instruction configuration

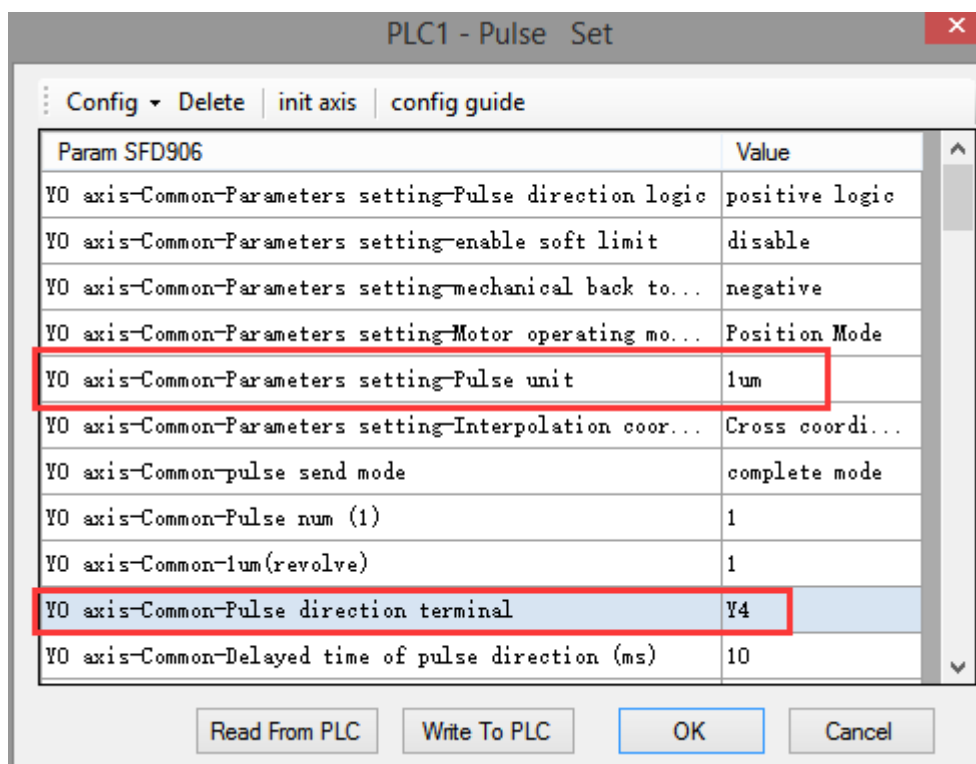

Axis Y0 system parameters (1)

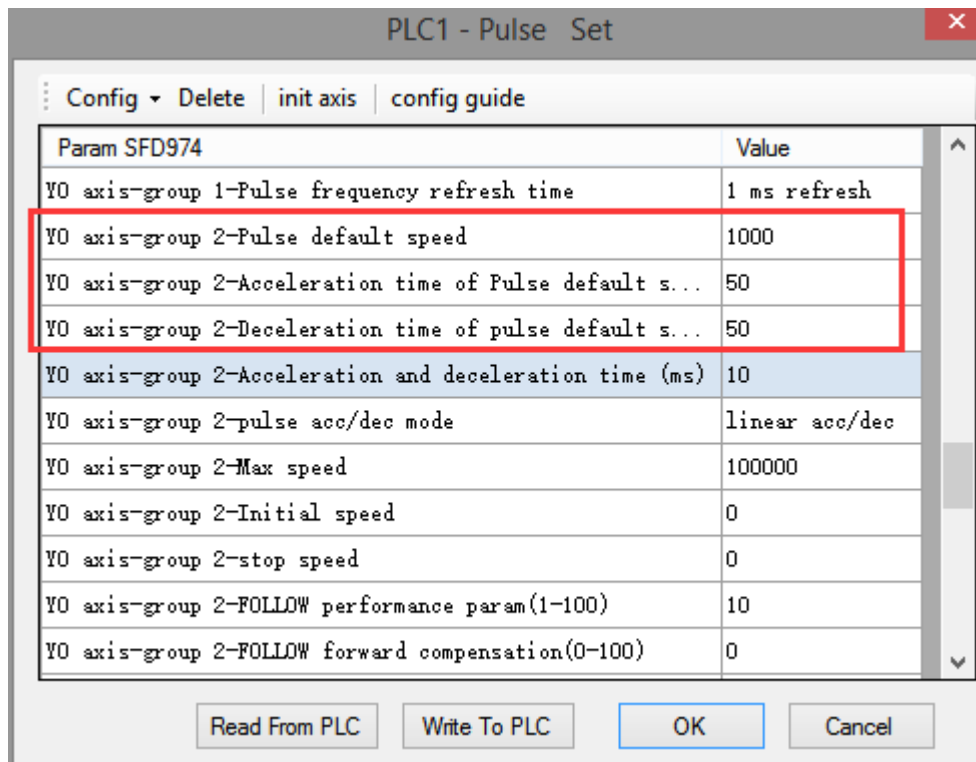

Axis Y0 system parameters (2)

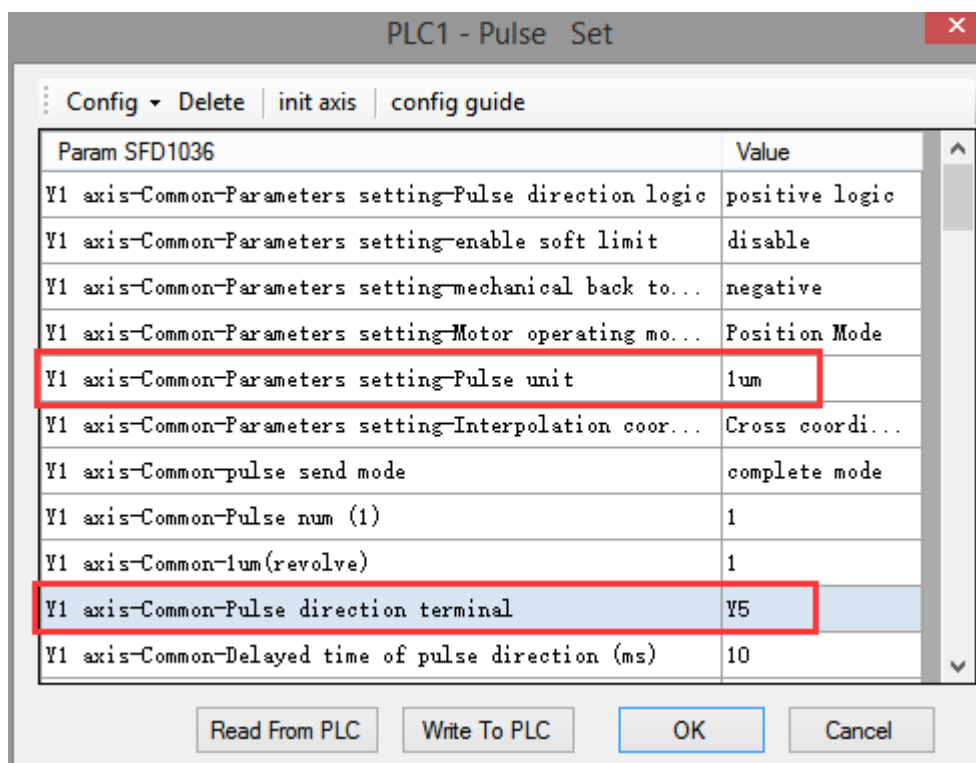

Axis Y1 system parameters

- As shown in the figure, D0 specifies the final position of axis 1 and D10 specifies the final position of axis 2, D20 specifies the midpoint of axis 1 and D30 specifies the midpoint of axis 2, D40 specifies the max speed.

- Y0 is the pulse output port of axis 1 and Y1 is the pulse output port of axis 2. See Sections 2-3 for other optional ports.
  - The directional terminals are Y4 and Y5, it is ON for the forward pulse and OFF for the reverse pulse.
  - Pulse frequency range: 1Hz ~ 100KHz; Acceleration and deceleration time: 0 ~ 65535ms.
  - Location movement can be viewed in equivalent cumulative registers HSD2 and HSD6.
  - Assuming HSD2 = 1000, HSD6 = 1000, D0 = 5000, D10 = 2000, D40 = 500Hz, when M0 rises, execute ARC command, move from the starting position (1000, 1000) to the target position at the max speed of 500Hz.
- (1) When the end point is in absolute mode, the target position is (5000,2000)
- (2) When the end point is in the relative mode, the target position is (6000,3000)
- When the ARC instruction is running, the pulse flag bit corresponding to its output port Y will be set on.
  - The completion of the interpolation instruction can be judged by BLOCK executing flag bit. For example, the flag bit of BLOCK1 is SM300, when SM300 changes from ON to OFF, it means that BLOCK1 has finished executing.

### Mode 3: ARC three-point arc VBEM

#### 1. Instruction overview

Three-point arc interpolation instruction, operate according to the set maximum synthetic speed, start speed and stop speed. This instruction can only be used in BLOCK. See Section 2-2 for specific usage.

Three-point arc interpolation [ARC]			
16-bit instruction	-	32-bit instruction	ARC
Execution condition	Rise/fall edge of coil	Suitable model	XDM, XDME, XLME, XDH
Firmware	V3.3 and above	Software	V3.3 and above

#### 2. Operand

Operand	Function	Type
S0	Axis 1 target position	Double words, 32-bit
S1	Axis 2 target position	Double words, 32-bit
S2	Axis 1 midpoint position	Double words, 32-bit
S3	Axis 2 midpoint position	Double words, 32-bit
S4	Specify the starting speed at the starting point of the two axes	Double words, 32-bit
S5	Specify the stop speed at the end point of the two axes	Double words, 32-bit
S6	Max speed of the two axes	Double words, 32-bit

D0	Pulse output port of axis 1	Bit
D1	Pulse output port of axis 2	Bit

## 3. Suitable soft component

Word	Operand	System							Constant	Module	
		D*	FD	TD*	CD*	DX	DY	DM*	DS*	K/H	ID
	S0~S6	•	•	•	•						
Bit	Operand	System									
		X	Y	M*	S*	T*	C*	Dnm			
	D0		•								
	D1		•								

\* Note: D denotes D HD; TD denotes TD HTD; CD denotes CD HCD HSCD HSD; DM denotes DM DHM; DS denotes DS DHS; M denotes M HM SM; S denotes S HS; T denotes T HT; C denotes C HC.

## 4. Parameter setting

Related parameters	Setting	Note
Final position	Determine the end point position according to relative/absolute mode	Must set
Relative/absolute	Relative: the above position as a reference; absolute: the origin as a reference	Must set
Midpoint position	Determine the midpoint position according to the shape of the arc	Must set
Max speed	Specify maximum smooth running speed of two axes	Must set
Start speed	The start speed from the starting point	Must set
Stop speed	The stop speed at the end point	Must set
Pulse output port of axis 1	Arbitrary specify pulse output point	Must set
Pulse output port of axis 2	Arbitrary specify pulse output point	Must set
Direction port of axis 1	Arbitrarily specify idle output points, set in system parameters	Must set
Direction port of axis 2	Arbitrarily specify idle output points, set in system parameters	Must set
Pulse unit	The pulse number or equivalent are acceptable. Set in axis 1 system parameters	Must set
Default speed	set in axis 1 group 2 parameters	No need to set
Acceleration time	Set in axis 1 group 2 parameters	No need to set
Deceleration time	Set in axis 1 group 2 parameters	No need to set

## Function and action

«Instruction format»

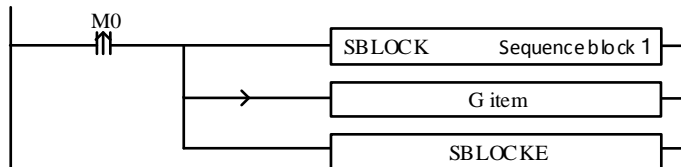

When the ARC instruction of arc interpolation (mode 3) is executed, the two axes will run at the set max synthesis speed, start speed and stop speed. As shown in the following figure:

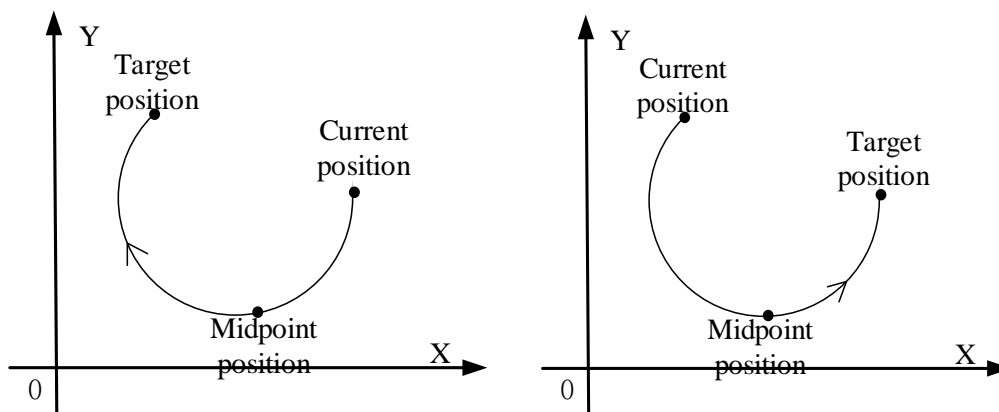

ARC arc interpolation

The parameter configuration is shown in the following figure:

Double-click G item and pop up the configuration panel. Set it as follows:

G Instruction

Skip      Comment: three point VBEM

ARC three point VBEM

	Params	Register	Absolute
S0	final position	D0	Absolute
S1	final position	D10	Absolute
S2	middle position	D20	Absolute
S3	middle position	D30	Absolute
S4	begin speed	D40	
S5	end speed	D50	
S6	max speed	D60	

OK      Cancel



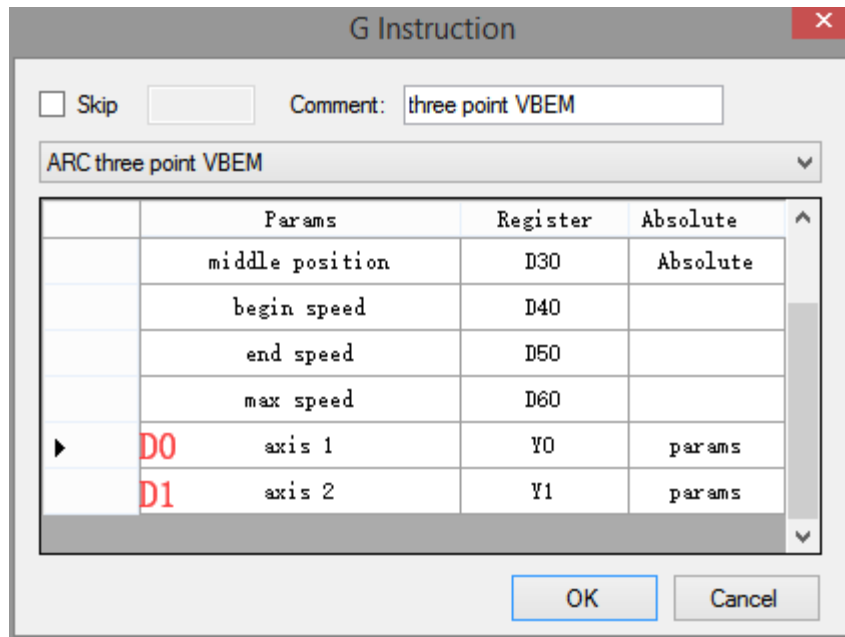

Instruction configuration

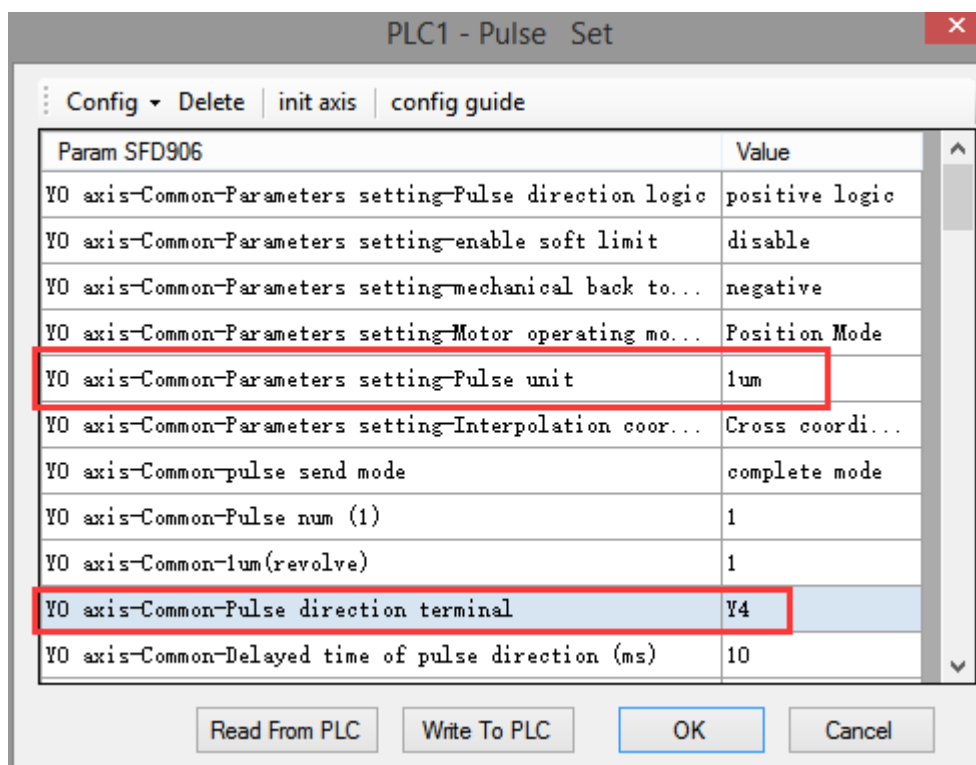

Axis Y0 system parameters (1)

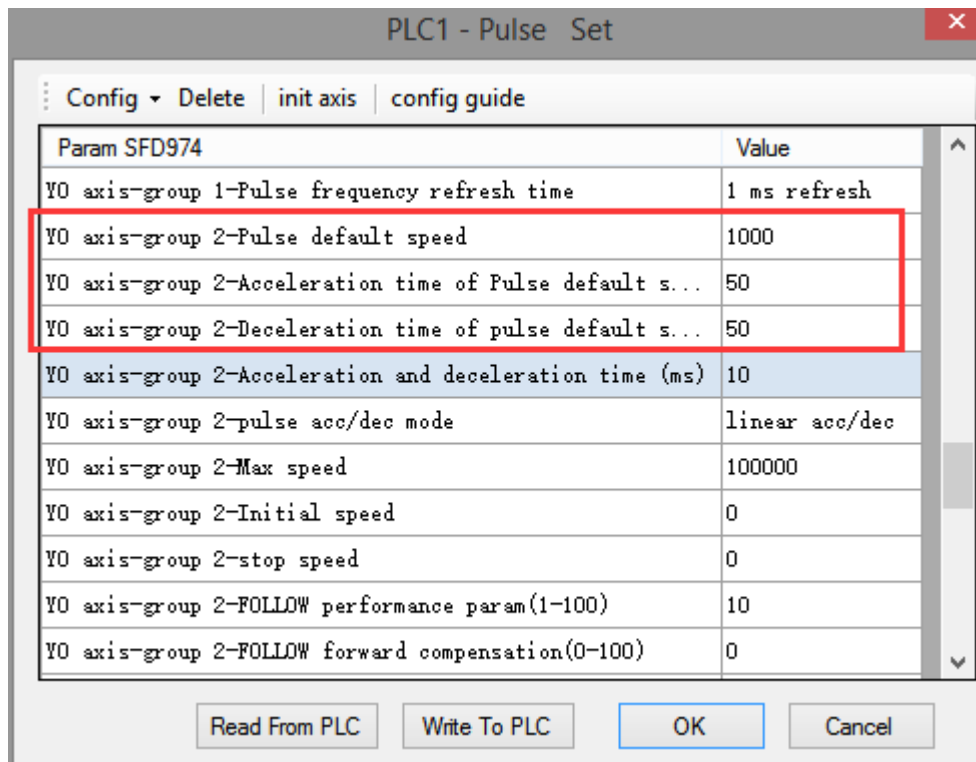

Axis Y0 system parameters (2)

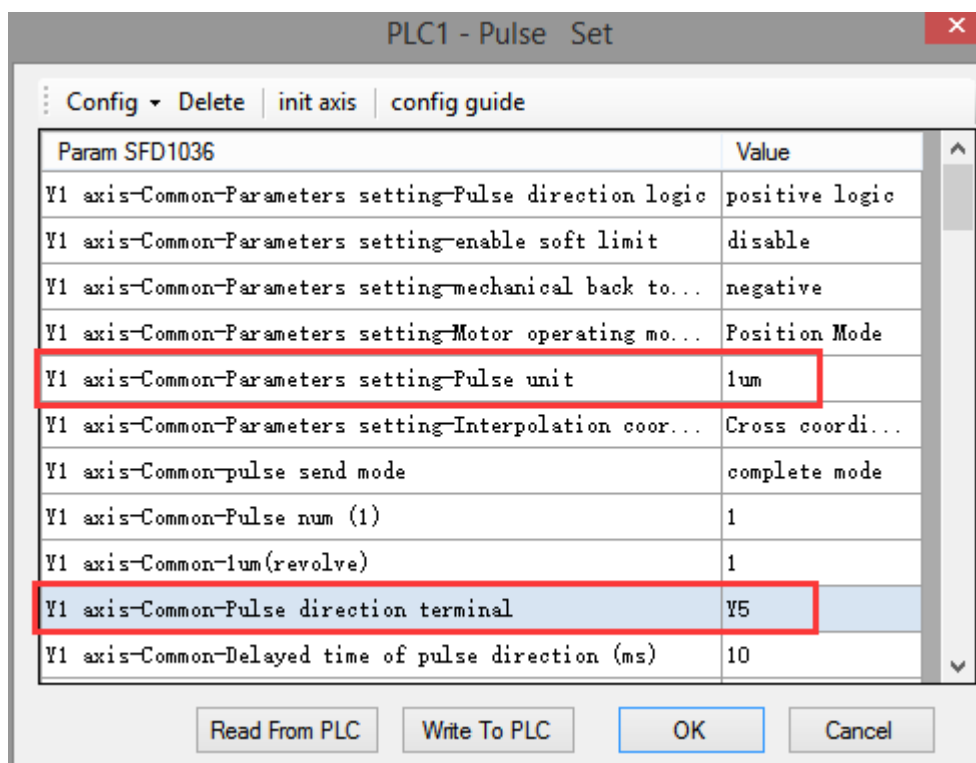

Axis Y1 system parameters

- As shown in the figure, D0 specifies the final position of axis 1 and D10 specifies the final position of axis 2, D20 specifies the midpoint position of axis 1, D30 specifies the midpoint position of axis 2, D40 specifies the start speed, D50 specifies the stop speed, D60 specifies the

max speed.

- Y0 is the pulse output port of axis 1 and Y1 is the pulse output port of axis 2. See Sections 2-3 for other optional ports.
  - The directional terminals are Y4 and Y5, it is ON for the forward pulse and OFF for the reverse pulse.
  - Pulse frequency range: 1Hz ~ 100KHz; Acceleration and deceleration time: 0 ~ 65535ms.
  - Location movement can be viewed in equivalent cumulative registers HSD2 and HSD6.
  - Assuming HSD2 = 1000, HSD6 = 1000, D0 = 5000, D10 = 2000, D40 = 50Hz, D50 = 20, D60 = 2000, when M0 rises, execute ARC command, accelerate from the starting position (1000,1000) at speed 50Hz to the maximum speed (2000Hz), and stop at the end speed of 20Hz when moving to the target position.
- (1) When the end point is in absolute mode, the target position is (5000,2000)  
 (2) When the end point is in the relative mode, the target position is (6000,3000)
- When the ARC instruction is running, the pulse flag bit corresponding to its output port Y will be set on.
  - The completion of the interpolation instruction can be judged by BLOCK executing flag bit. For example, the flag bit of BLOCK1 is SM300, when SM300 changes from ON to OFF, it means that BLOCK1 has finished executing.

Note: In this mode, the starting speed (S4), the ending speed (S5) and the maximum speed (S6) are all expressed as the two-axis synthesis speed, as shown in the following figure:

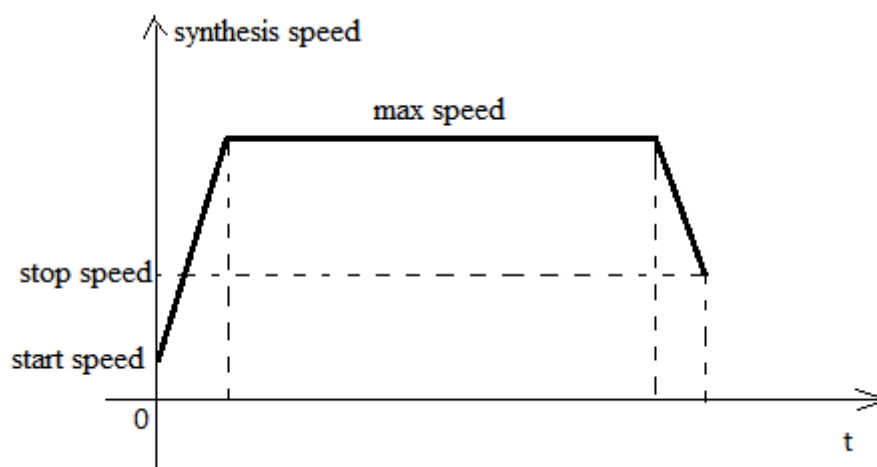

When there are multiple continuous linear/arc interpolation instructions and the speed between them needs to be constant and jump directly, the termination speed and maximum speed of the previous linear/arc interpolation can be set the same as the starting speed and maximum speed of the next segment.

When mode 3 is used, the starting and ending speed in the pulse parameter configuration tables of axis 1 and axis 2 are only effective for calculating the slope of pulse acceleration and deceleration.

### 2-4-9. Follow [FOLLOW] [FOLLOW\_AB]

Follow-up instructions are divided into single-phase incremental follow-up [FOLLOW] and AB phase follow-up [FOLLOW\_AB], which will be described in detail below.

#### 1. Instruction overview

Single-phase/AB-phase high-speed counter follow instructions. The instructions can be written directly in the main program or process.

Follow instruction [FOLLOW] [FOLLOW_AB]			
16-bit instruction	FOLLOW, FOLLOW_AB	32-bit instruction	-
Execution condition	Rise/fall edge of coil	Suitable model	XDM, XDME, XLME, XDH
Firmware	V3.3 and above	Software	V3.3 and above

#### 2. Operand

Operand	Function	Type
S0	Single-phase/AB phase high speed counter	Double words, 32-bit
S1	Register address of multiplication coefficient	Single word, 16-bit
S2	Register address of division coefficient	Single word, 16-bit
S3	System parameter block number	Single word, 16-bit
D	Pulse output port	Bit

#### 3. Suitable soft component

Word	Operand	System								Constant	Module			
		D*	FD	ID*	CD*	DX	DY	DM*	DS*	K/H	ID	QD		
	S0	Only can be High speed counter												
	S1	•	•	•	•							•	•	
	S2	•	•	•	•							•	•	
	S3	•	•	•	•					•		•	•	
Bit	Operand	System												
		X	Y	M*	S*	T*	C*	Dnm						
	D		•											

\* Note: D denotes D HD; TD denotes TD HTD; CD denotes CD HCD HSCD HSD; DM denotes DM DHM; DS denotes DS DHS; M denotes M HM SM; S denotes S HS; T denotes T HT; C denotes C HC.

## 4. Parameter setting

Related parameters	Settings	Note
High speed counter	The high-speed counter corresponding to FOLLOW must be single-phase incremental mode The high-speed counter corresponding to FOLLOW_AB must be AB phase mode.	Must set
Multiplication coefficient/division coefficient	Range: -1000~1000 and not equal to 0 (follow-up instructions will not be executed when out of range). The multiplication coefficient/division coefficient is negative to indicate the positive count and send the reverse pulse. Dynamic modifications can take effect immediately.	Must set
System parameter block number	System parameters corresponding to pulse output axis, the range is 1~4	Must set
Pulse output port	Arbitrary designated pulse output point	Must set
Pulse direction	It can be set in the selected system parameter block or set separately.	Must set
Pulse unit	Must set to pulse number, please set in the system parameter of the output axis	Must set
FOLLOW performance parameter	1~100 (report error when out of range), default value is 50	No need to set
FOLLOW feedforward compensation	0~100 (report error when out of range), default value is 0	No need to set
Positive/negative limit	Hard limit can be set in system parameters of output axis	No need to set
Positive/negative value of soft limit	Soft limit can be set in system parameters of output axis	No need to set

**Function and action**

## 《Instruction format》

For single-phase incremental mode high speed counter:

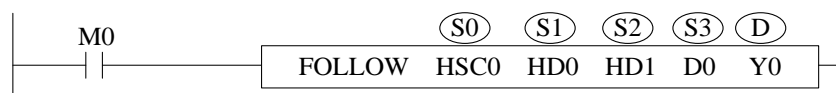

For AB-phase mode high speed counter:

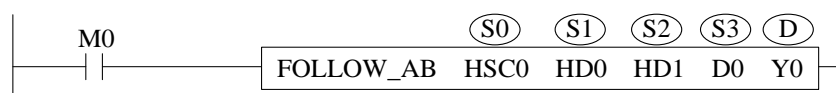

- FOLLOW/FOLLOW\_AB instruction is a servo function. Through the pulse feedback of encoder or hand pulse generator, the frequency and number of input pulses are measured by PLC in real time. Through the proportional relationship between multiplication coefficient and division coefficient, the corresponding pulse frequency and the number of pulses are output to control the stepping or servo motor.
- This instruction is generally used for manual adjustment of CNC system, and it is used for advancing and retreating of the operating table of the pulse generator by hand. It can also be used in some special projects where precise synchronous control is needed.
- Pulse output is based on the variation of HSC0, that is to say, in 4-time mode, if the multiplier/divider coefficient is 1, the output of the pulse is equal to 4 times the input of the pulse. The number of pulses at the output port is stored in the pulse cumulative register, namely HSD0 (double word), HSD4 (double word)... And so on.
- For FOLLOW instructions, the high-speed counter inputs a single-phase pulse, so the number of Y-port pulses is increasing regardless of the input inversion, and the corresponding pulse direction terminal is always ON, which will not be OFF when inversion occurs.
- For FOLLOW\_AB instruction, the input of high-speed counter is AB phase pulse. Y port will increase and decrease with the increase of input pulse, and the direction is the same as that of high-speed counter input.
- The forward and reverse flag bit of the follow-up instruction is the direction flag bit of the high-speed counter.
- When the Y0 port outputs the pulse, the SM1000 will be set on.
- Follow-up instruction supports hard limit, soft limit, emergency stop and slow stop functions. See the description of the parameters of the pulse system.
- XDM-24/32 supports 4 channels, XDM-60T10 supports 10 FOLLOW instructions, and can execute 4 or 10 FOLLOW instructions simultaneously.

**Note:**

- (1) During operation, the corresponding HSCD and HSD can not be changed arbitrarily. If it needs to be cleared, it must be cleared at the same time.
- (2) If the high-speed counter needs to be cleared, the clearing instruction must be executed after the condition of FOLLOW or FOLLOW\_AB is disconnected and at least two scanning cycles are spaced.

For example, after disconnecting the condition X2, a short delay is made, and the clearing instruction is executed after the time is up.

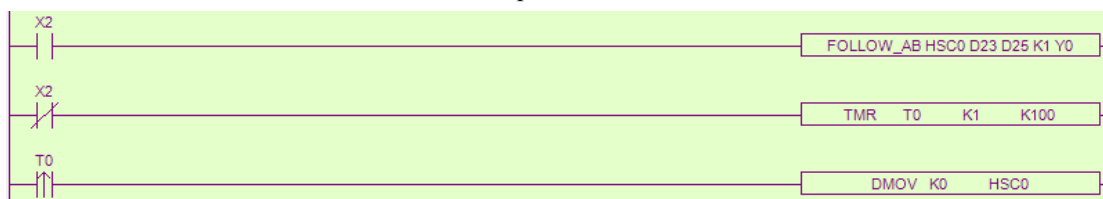

- (3) It is forbidden to write two (or more) follow-up instructions to the same high-speed counter

in the program.

- (4) It is forbidden to have both FOLLOW (or FOLLOW\_AB) and CNT (or CNT\_AB) instructions for the same high-speed counter in the program.
- (5) The follow-up instruction can be executed simultaneously with the interpolation instruction, but the output port can not overlap.
- (6) High-speed counting must be given pulse input by external input terminal, and can not be used by HSCW writing mode.
- (7) Follow-up instructions cannot use the same high-speed counter as high-speed counting read-write instructions. When FOLLOW instructions need to write multiple instructions from the same high-speed counting source, they can be written in different processes, and only one process can be conducted at the same time.
- (8) FOLLOW instruction resource conflict is corresponding to AB phase high-speed counting resource conflict.

The following is instruction diagram of FOLLOW/ FOLLOW\_AB(take Y0 as an example):

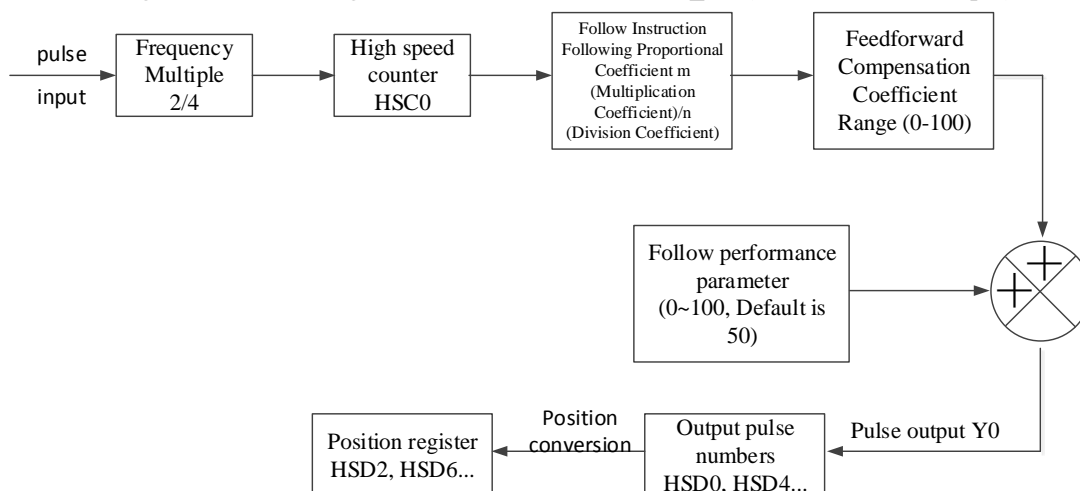

### The relationship between follow-up instructions and motion control instructions:

- (1) The follow-up command can be used separately from the motion control command. However, when manual pulse generator is needed to adjust the coordinate position, it is necessary to establish the relationship between follow-up and motion control.
- (2) When the pulse mode is equivalent, the change of the number of pulses is converted to the change of the position of the corresponding output axis, which is reflected in the HSD2 (double-word) register, so that the follow-up instructions and the motion control system constitute an organic whole. Therefore, the following changes can be directed either to axis 1 or to axis 2.
- (3) The change of position is consistent with the change of pulse, which can only increase but not decrease.

**FOLLOW performance parameters:**

The function of this parameter is similar to the rigidity function of servo driver. The smaller the setting value of this parameter is, the smaller the servo rigidity will be (the greater the delay); the larger the setting value of this parameter is, the greater the servo rigidity will be (the smaller the delay will be). Setting range: 1 ~ 100 (error will be reported if exceeding range), default setting is 50.

**FOLLOW feedforward compensation:**

(1) There is always a certain delay between receiving and sending out pulses in PLC. In order to reduce the lag effect, the feedforward compensation parameters can be modified to compensate for the lag effect, so that the pulse output has a certain advance, to offset the lag effect. However, if the feedforward parameters are set large, it may lead to entering the compensation cycle, which will lead to the continuous jitter of the motor at the end of the follow-up. Setting range: 0-100 (error will be reported when exceeding the range), default is 0, equivalent to no feedforward compensation.

(2) Normally, this parameter does not need to be set.

**Limit bit description (fit for all motion instructions):**

(1) When the positive motion is detected, the rising edge of the positive limit is detected, and the deceleration begins until it stops. At this time, only the negative motion can be achieved. In the process of negative motion, only when the descending edge of positive limit is detected, can two-way motion be achieved.

(2) When the negative motion is detected, the rising edge of the negative limit is detected, and the deceleration begins until it stops. At this time, only the positive motion can be achieved. In the process of positive motion, only after the negative limit drop edge is detected, can the two-way motion be achieved.

(3) When the instruction starts to execute, it can only move negatively if it is in the positive limit. If it is in the negative limit, it can only move forward.



## 2-5. Hardware wiring and precautions

### 2-5-1. Input wiring

XD series PLC input is divided into NPN and PNP modes (XL series only supports NPN type wiring). The internal structure and wiring mode of the two modes are introduced below.

#### 2-5-1-1. XD series PLC input wiring

- **NPN mode**

Input signal voltage	DC24V ± 10%
Input signal current	7mA/DC24V
Input ON current	Below 4.5mA
Input OFF current	Below 1.5mA
Input response time	About 10ms
Input signal mode	Contact input or NPN open collector transistor
Circuit insulation	Photoelectric coupled insulation
Input action display	LED lights when input is ON

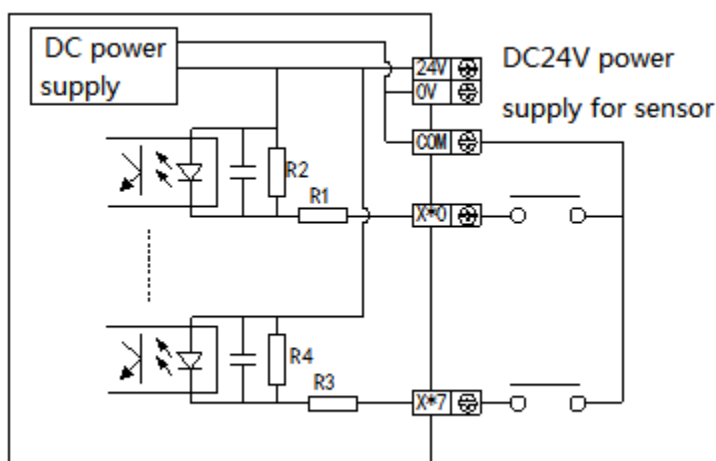

#### XD series NPN wiring example

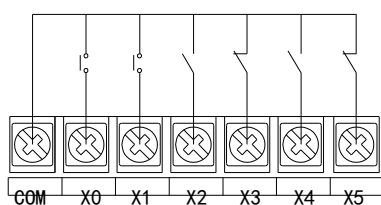

Switch button wiring

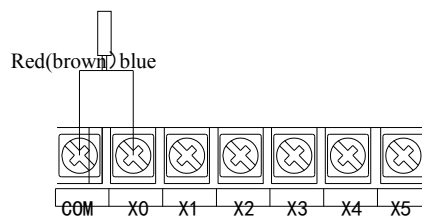

two-wire (NO or NC) proximity switch wiring

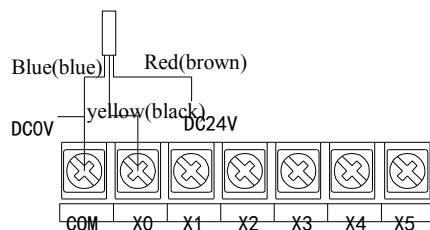

Three-wire (NPN) proximity switch wiring

● PNP mode

Input voltage	signal	DC24V ± 10%
Input current	signal	7mA/DC24V
Input ON current		Below 4.5mA
Input OFF current		Below 1.5mA
Input response time		About 10ms
Input signal mode		Contact input or PNP open collector transistor
Circuit insulation		Photoelectric coupled insulation
Input display	action	LED lights when input is ON

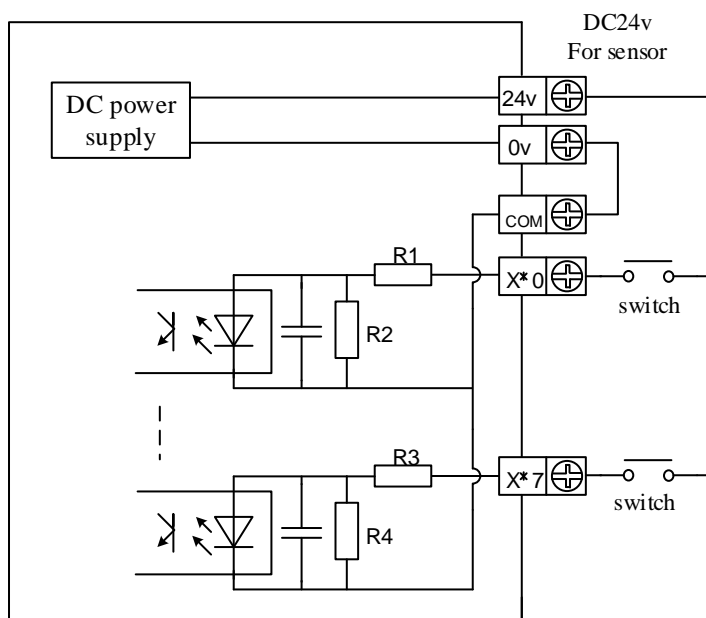

## PNP wiring example

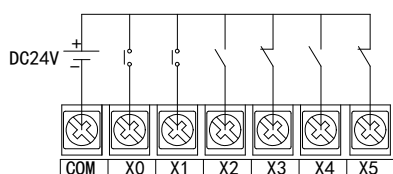

Switch button wiring

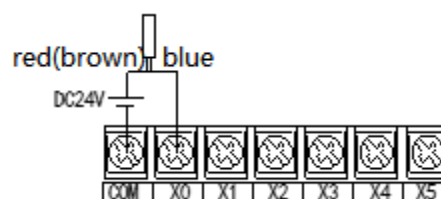

two-wire(NO or NC) proximity switch wiring

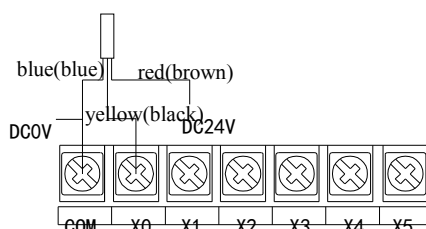

Three-wire (PNP) proximity switch wiring

### 2-5-1-2. XL series PLC input wiring

- **Input specifications (NPN mode)**

#### XL general models:

Input signal voltage	DC24V $\pm$ 10%
Input signal current	7mA/DC24V
Input ON current	Below 4.5mA
Input OFF current	Below 1.5mA
Input response time	About 10ms
Input signal mode	Contact input or NPN open collector transistor
Circuit insulation	Photoelectric coupled insulation
Input action display	LED lights when input is ON

#### XL5E-64T6:

Input signal voltage	DC24V $\pm$ 10%
Input signal current	7mA/DC24V
Input ON voltage	Below 9V
Input OFF voltage	Above 19V
Input response time	About 10ms
Input signal mode	Contact input or NPN open collector transistor
Circuit insulation	Photoelectric coupled insulation

Input action display	LED lights when input is ON
----------------------	-----------------------------

● **XL series PLC NPN input wiring example**

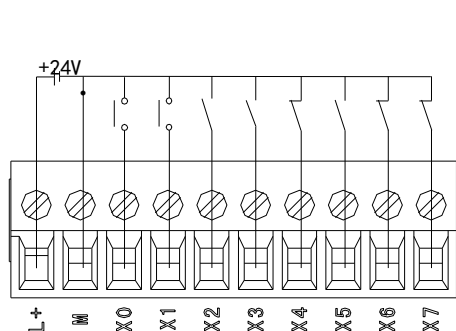

Switch button wiring

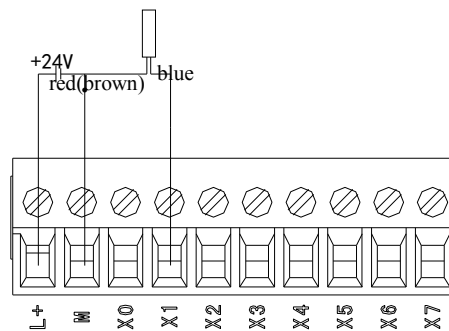

two-wire(NO or NC) proximity switch wiring

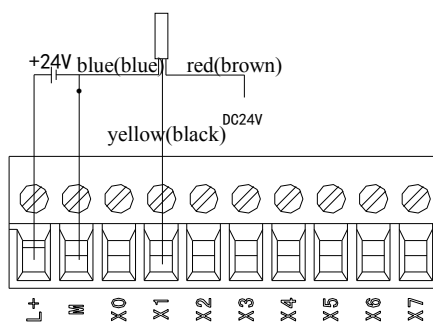

Three-wire (NPN) proximity switch wiring

**2-5-1-3. Attentions for connection of input points**

- The input type must be OC signal (collector open circuit signal).
- DC24 does not need to connect DC0V to COM of input point if it uses DC24V provided by PLC body; if it uses external power supply, it must be connected.

**2-5-1-4. Hand pulse generator connection**

Hand pulse generator is also known as hand artery impulse generator, hand pulse, electronic handwheel and so on. It is used to zero correction and signal segmentation for CNC machine tools, printing machinery, etc. It works like an encoder.



The output signal of the hand pulse generator must be OC (collector open circuit signal) DC24V type. Generally, there will be five wires, three signal wires (A, B, Z), two power wires (24V, 0V), signal wires connected with the corresponding high-speed counting input port of the PLC. The power supply can be supplied by the output 24V of the PLC or by the switching power supply.

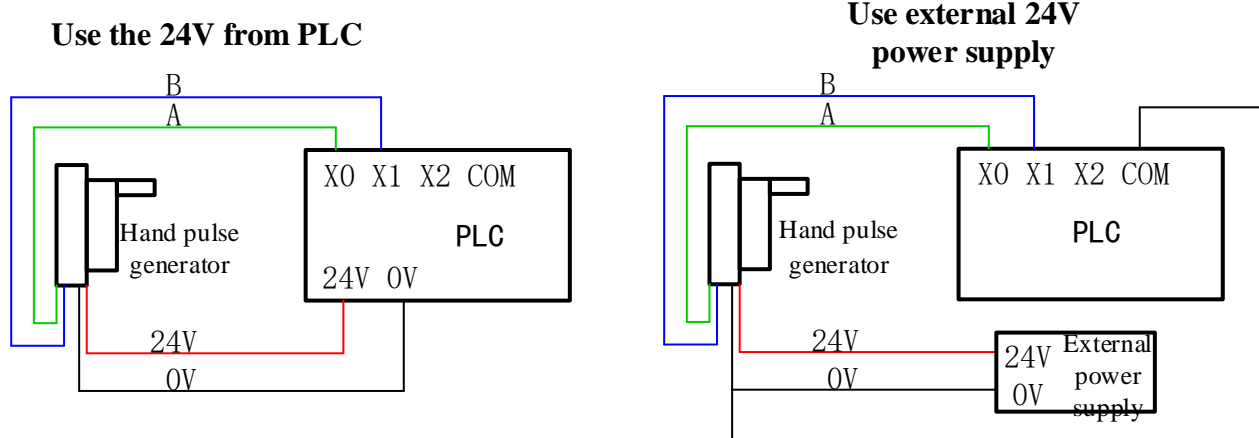

Note: When using external switching power supply, the COM of PLC input should be short connected with 0V.

## 2-5-2. Output wiring

For XD/XL series PLC, the output terminal of motion control command needs high-speed pulse output terminal. Other transistors are ordinary optocouplers. For specifications and introduction, please refer to "XD/XL Series PLC Hardware User Manual".

### 2-5-2-1. High speed pulse output specification parameters

Model	XDM-24T4/32T4/60T4/60T4L XDM-60T4, XDH-60T4, XLME-32T4	XDM-60T10, XDME-60T10
High speed pulse output port	Y0~Y3	Y0~Y11

External power supply	DC5~30V
Action display	LED light
Max current	50mA
Pulse max output frequency	100KHz

Note: PLC can output 100KHz ~ 200KHz pulses, but it can not guarantee the normal operation of all servos. Please connect about 500 Ω resistance between the output and 24V power supply.

**2-5-2-2. Cautions for output point connection**

If it is XDM-60T10-E or XDME-60T10-E, the output point Y12-Y27 should be used when the output point of the photocoupler is connected with the power load.

**2-5-2-3. Connecting with stepping driver/servo driver**

Below is the diagram of the connection between the T-type output terminal and the stepper motor driver.

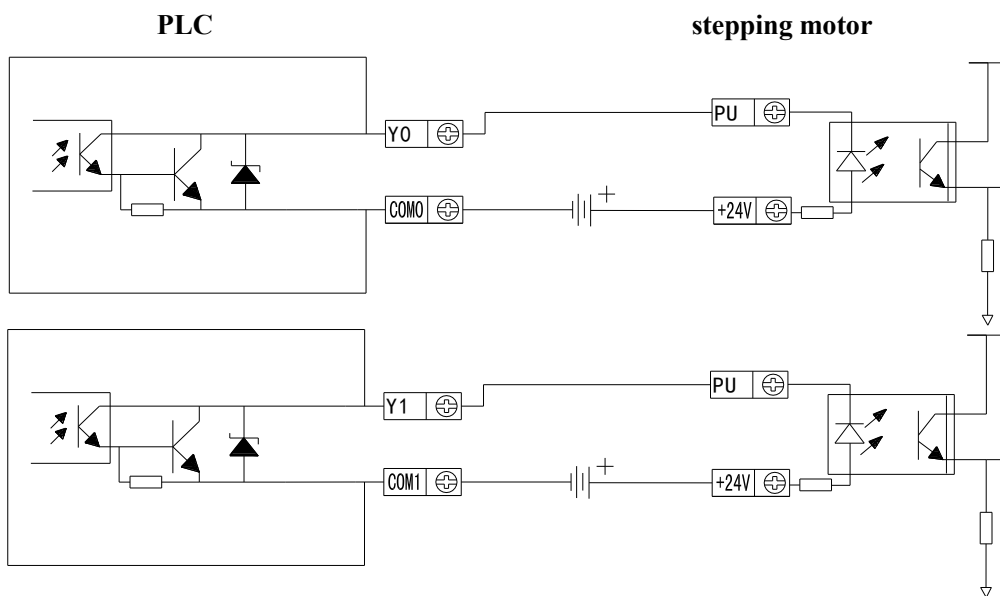

Note: If the pulse and direction terminals of the stepper motor are driven by DC5V, please connect 2.2K Ω resistance behind the pulse and direction terminals.

Below is the diagram of the connection between the T-type output terminal and XINJE servo motor driver.

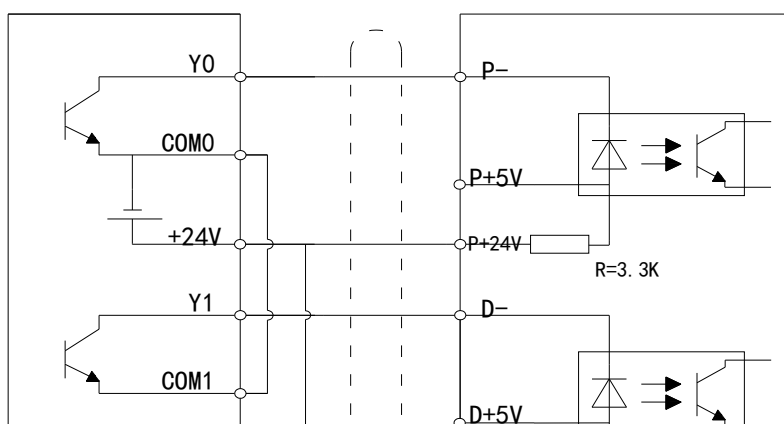

Note: Please suspend P+5V and D+5V.

Detailed hardware wiring diagram refers to "XD/XL Series PLC Hardware User Manual."

## 2-6. Examples

### 2-6-1. Isosceles triangle

Step out of an isosceles triangle with a side length of 5000 and a bottom of 6000. The starting point is A (0, 0), from A (0, 0) to B (3000, 4000), then from B (3000, 4000) to C (6000, 0), and finally from C (6000, 0) back to the starting point A (0, 0), as shown in the figure:

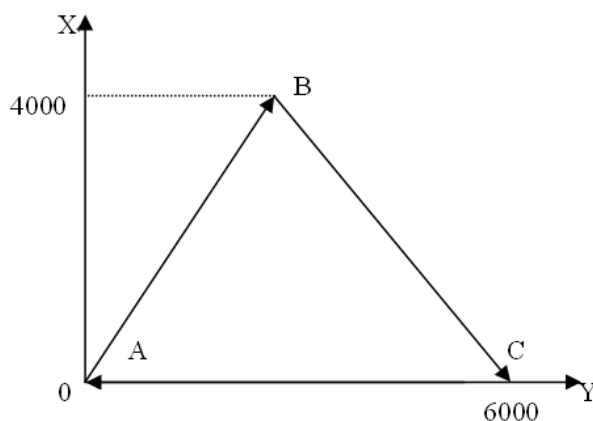

#### Explain:

The two axes are designated Y0 (Y axis) and Y1 (X axis). The corresponding directional terminals are Y4 and Y5. The coordinates of B point are (D0, D10), C point are (D2, D12), A point is (D4, D14), the speed is 1000Hz, and the acceleration and deceleration time are 50ms. The relevant parameters are set as follows:

coordinates	X axis address	X axis setting value		Y axis address	Y axis setting value	
		absolute	relative		absolute	relative
B point	D0	3000	3000	D10	4000	4000
C point	D2	6000	3000	D12	0	-4000
A point	D4	0	-6000	D14	0	0
Default speed (Hz)		1000				

Acceleration/deceleration time (ms)	50
X axis	Y0-pulse; Y4-direction
Y axis	Y1-pulse; Y5-direction

**Program I (absolute mode):**

Add the G item in BLOCK, add three LIN instructions in it, as shown below:

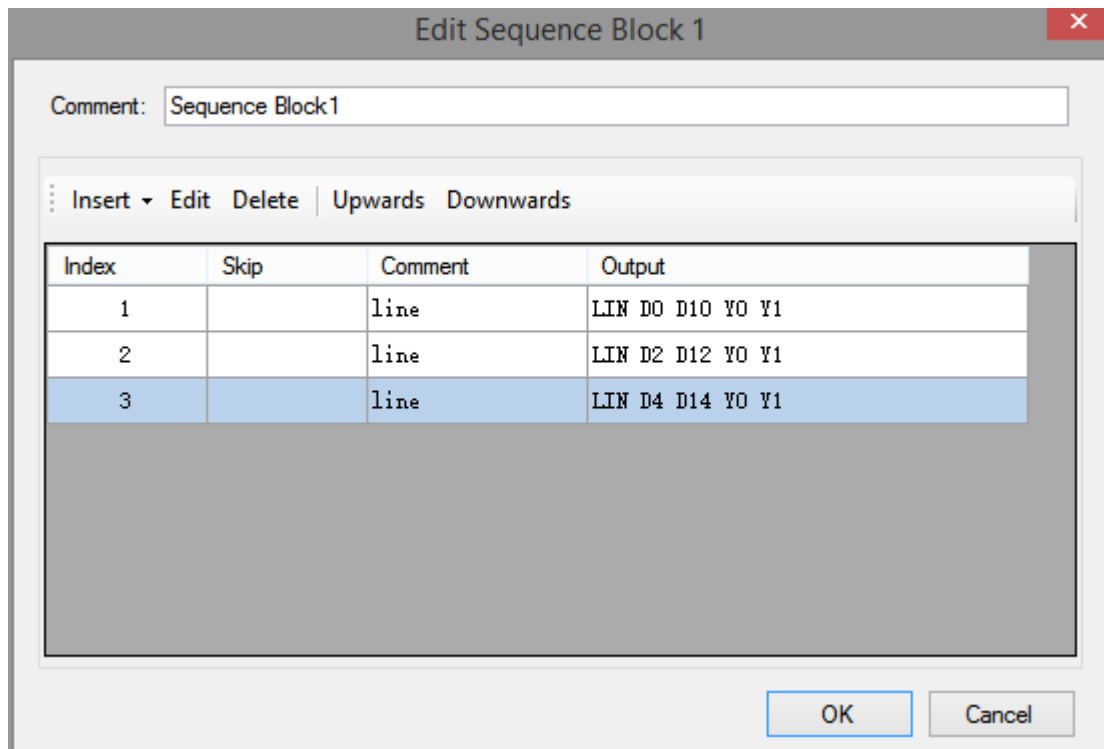

The configuration of the three instructions:

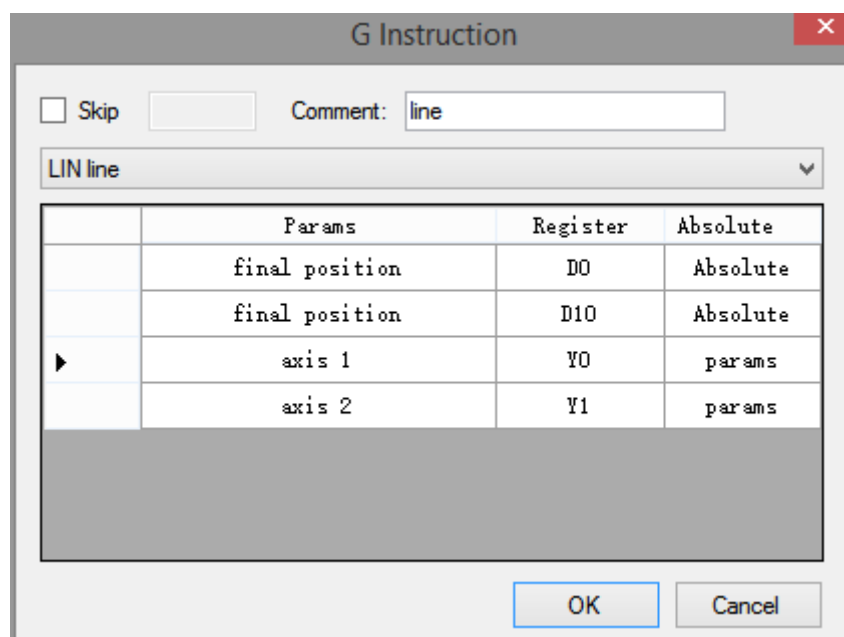

The first one (A→B)



**G Instruction** ✕

Skip        Comment:

LIN line ▾

	Params	Register	Absolute
	final position	D2	Absolute
	final position	D12	Absolute
▶	axis 1	Y0	params
	axis 2	Y1	params

OK    Cancel

**The second one (B→C)**

**G Instruction** ✕

Skip        Comment:

LIN line ▾

	Params	Register	Absolute
	final position	D4	Absolute
	final position	D14	Absolute
▶	axis 1	Y0	params
	axis 2	Y1	params

OK    Cancel

**The third one (C→A)**

Double click parameters, configure the Y0 axis parameters, as shown below:

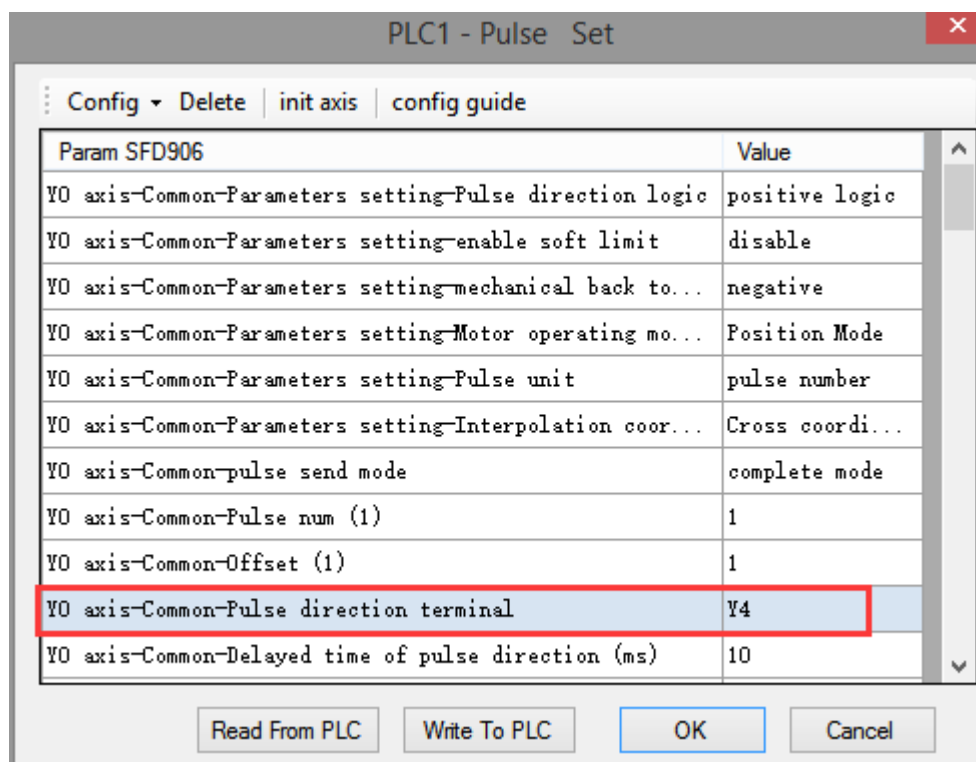
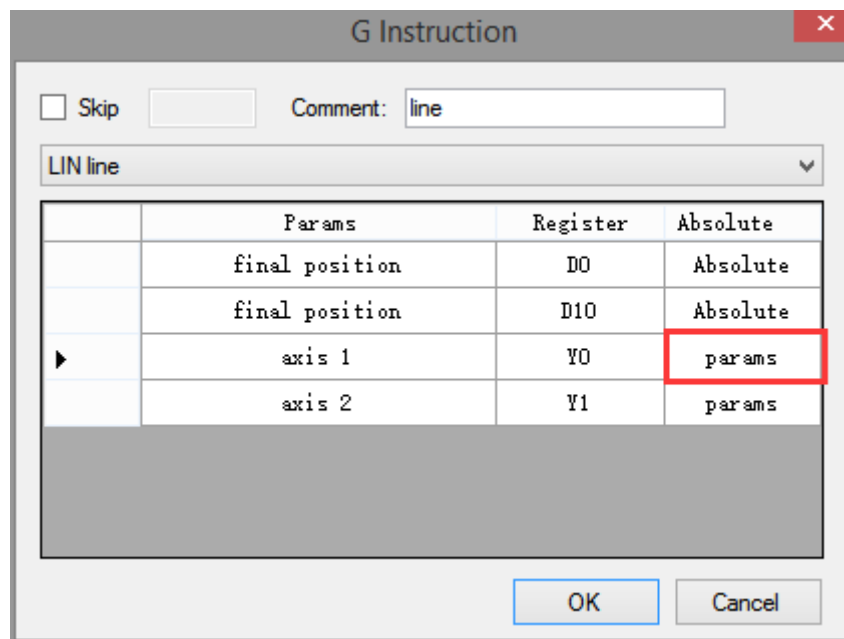

**Y0 axis pulse direction terminal is set to Y4**

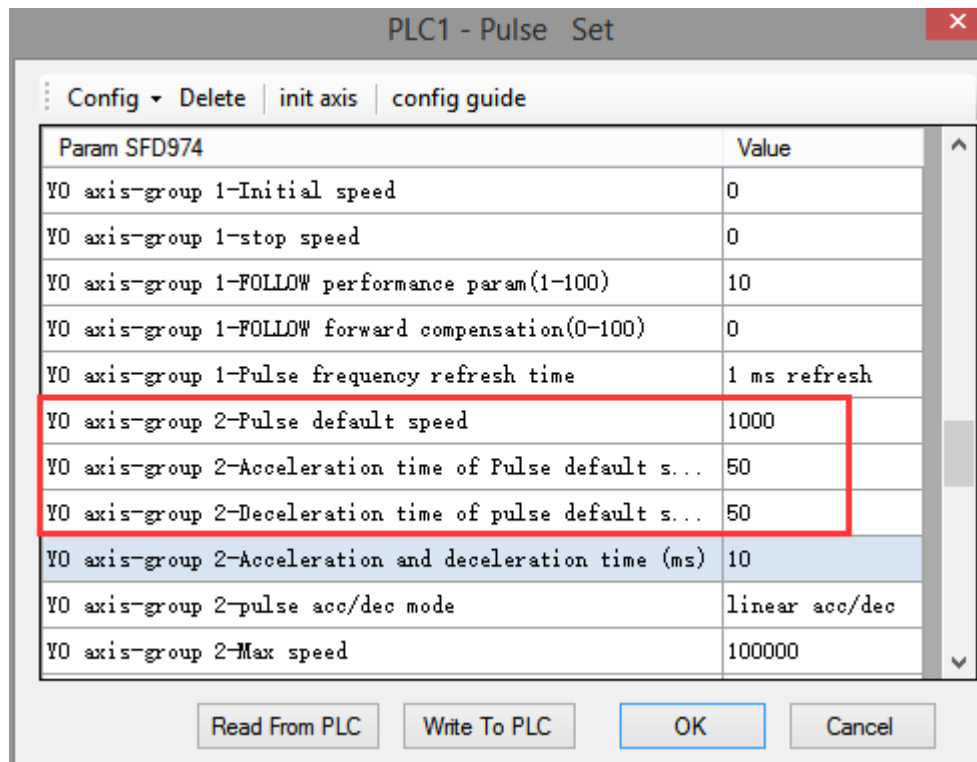

Y0 axis pulse default speed is set to 1000, acc/dec time is 50ms

Double click parameters, configure the parameters of Y1 axis, as shown below:

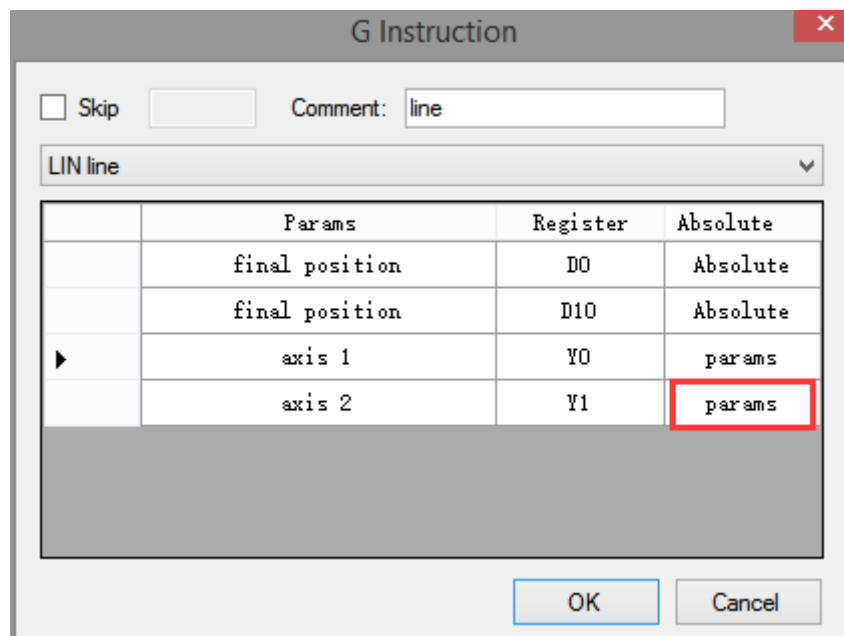

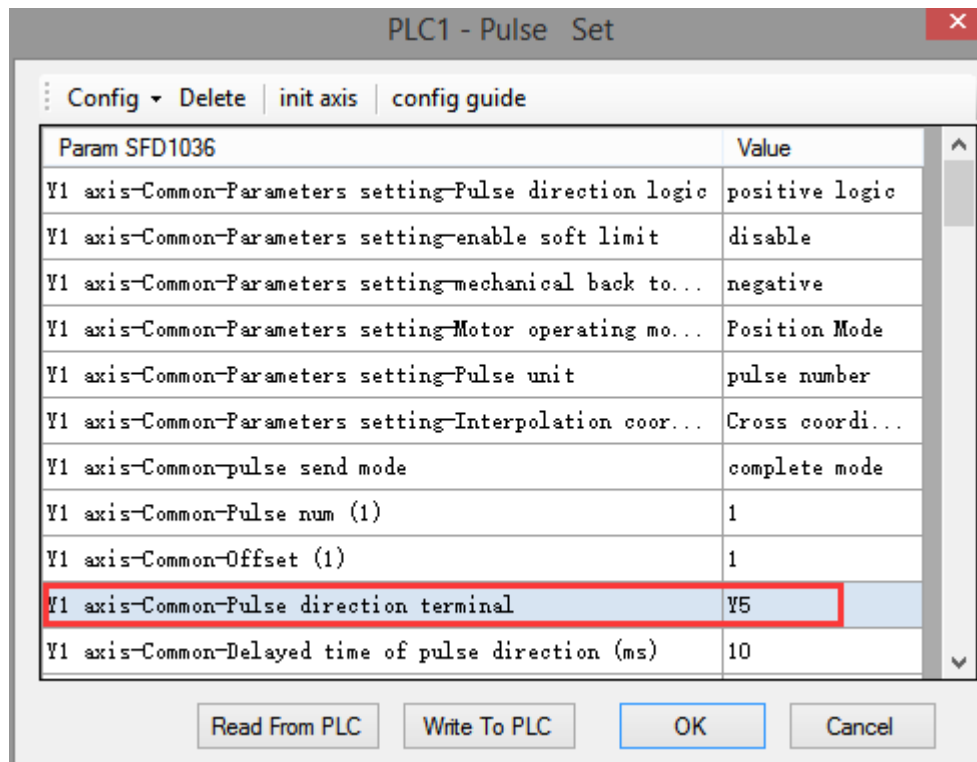

Y1 axis pulse direction terminal is set to Y5

After setting up, click OK to generate the program shown in the following figure in the ladder diagram. Write the set values in D0, D2, D4, D10, D12, D14. When M0 is turned on once, perform BLOCK once, and take a triangular route.

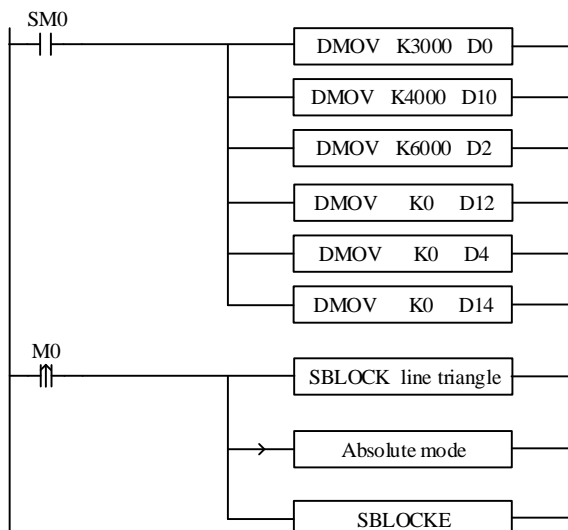

**Program II (relative mode):**

Three linear interpolation instructions [LIN] are added to the BLOCK by using the relative mode, as shown in the following figure:

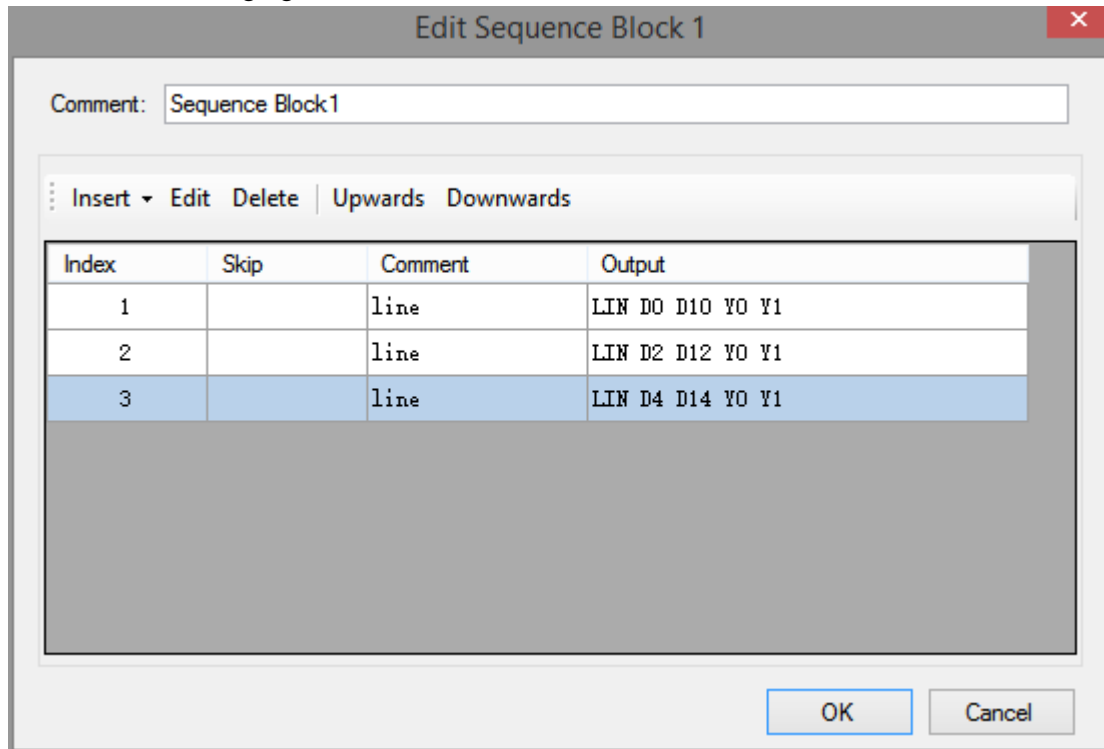

The three instructions are shown as below:

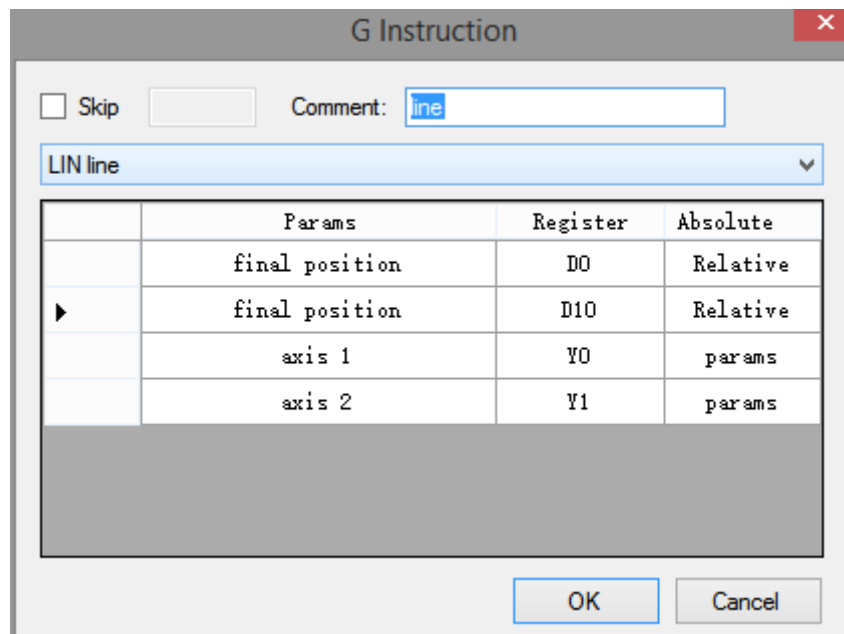

First one (A→B)

	Params	Register	Absolute
	final position	D2	Relative
▶	final position	D12	Relative
	axis 1	Y0	params
	axis 2	Y1	params

The second one (B→C)

	Params	Register	Absolute
	final position	D4	Relative
▶	final position	D14	Relative
	axis 1	Y0	params
	axis 2	Y1	params

The third one (C→A)

Double-click "parameters" to configure parameters of Y0 and Y1 axis [pulse direction terminal], [group 2 parameters - pulse default speed (Hz)], [group 2 parameters - pulse default speed acceleration time (ms)], [group 2 parameters - pulse default speed deceleration time (ms)] in the same absolute mode, which will not be described here.

After setting up, click OK to generate the program shown in the following figure in the ladder diagram. Assuming that the current values of HSD2 (double word) and HSD6 (double word) are all 0, the set values are written in D0, D2, D4, D10, D12 and D14. When M1 is set ON once, BLOCK is executed once, and a triangular line is taken.

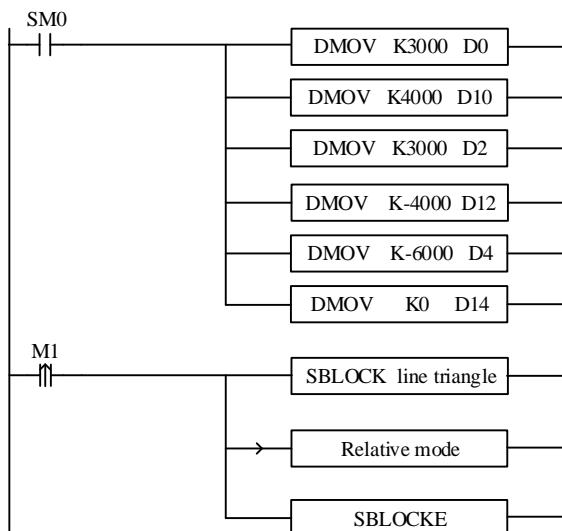
**Note:**

- (1) The current position pulses of the two axes can be monitored by HSD2 (double word) and HSD6 (double word).
- (2) The output terminals of the two axes correspond to Y0 and Y1 respectively, while the output terminals of the direction correspond to Y4 and Y5 respectively.

### 2-6-2. Circle + inscribed triangle

First step out of a circle with radius  $R = 5000$  clockwise, and then follow the pattern of the inner regular triangle of the circle. The starting point is  $A(0, 0)$ . First, follow the order of  $A(0, 0) \rightarrow B(7500, 4285) \rightarrow C(7500, -4285) \rightarrow A(0, 0)$  to form the circle, then from  $A(0, 0)$  to  $B(7500, 4285)$ , and then from  $B(7500, 4285)$  to  $C(7500, -4285)$  points, and finally returns from  $C(7500, -4285)$  points to the starting point  $A(0, 0)$  and completes an inner regular triangle of a circle, as shown in the figure.

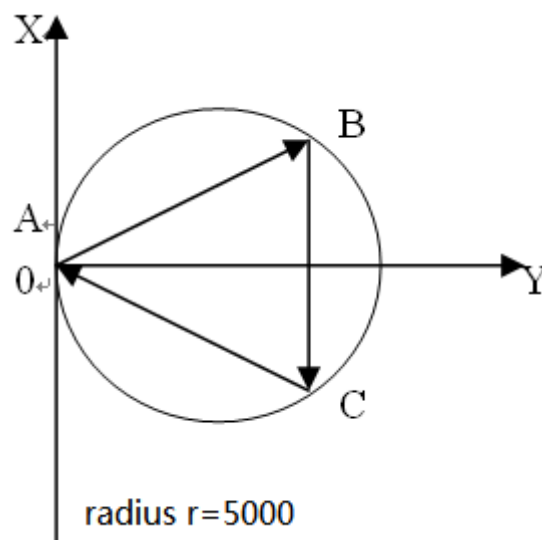

**Note:**

Two axes are designated as Y0 and Y1 axis, corresponding direction terminals are Y4 and Y5, B point coordinates are (D20, D22), C point coordinates are (D30, D32), A point coordinates are (D40, D42), starting speed is 50 Hz, stop speed is 50 Hz, maximum speed is 2000 Hz, default speed is 1000 Hz, acceleration and deceleration time is 50 ms, the specific parameters are set as follows:

Function	Register or coil address	Value
Endpoint coordinates of circular arcs	D0	0
	D2	0
Center coordinates	D4	5000
	D6	0
B point coordinates	D20	7500
	D22	4285
C point coordinates	D30	7500
	D32	-4285
A point coordinates	D40	0
	D42	0
Starting speed (Hz)	D8	50
Stop speed (Hz)	D10	50
Max speed (Hz)	D12	2000
Default speed (Hz)	-	1000
Acc/dec time (ms)	-	50
X axis	Y0 pulse, Y4 direction	
Y axis	Y1 pulse, Y5 direction	

**Program (absolute mode):**

Because of the coincidence of the starting point and the end point, the command "CW clockwise arc VBEM" is chosen here, and the command "LIN line VBEM" is used in the triangle. Insert G instruction into BLOCK and write four interpolation instructions, as shown in the following figure:



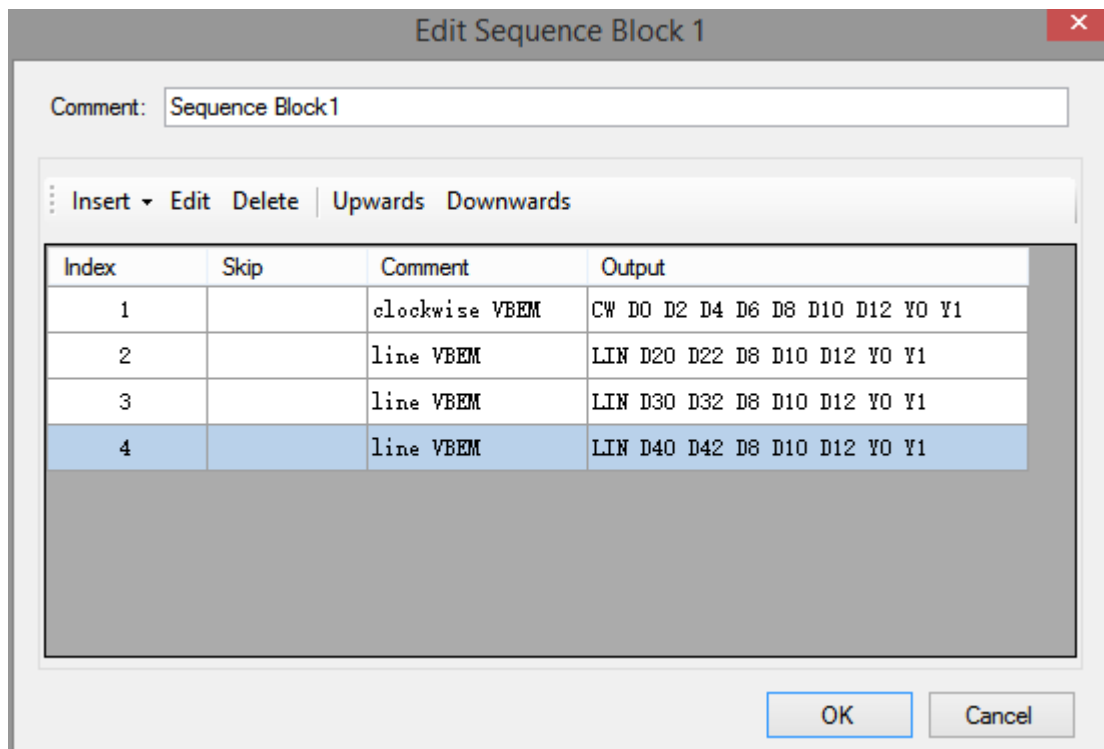

The four instructions are shown as below:

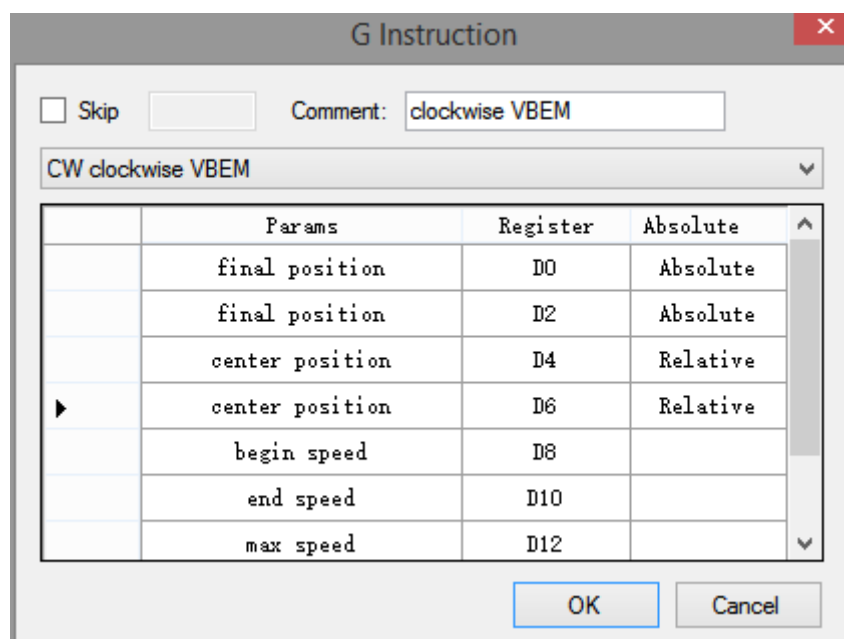

Instruction ① settings (1)

**G Instruction** ✕

Skip        Comment:

▾

	Params	Register	Absolute
▶	center position	D6	Relative
	begin speed	D8	
	end speed	D10	
	max speed	D12	
	axis 1	Y0	params
	axis 2	Y1	params

OK    Cancel

Instruction ① settings (2)

**G Instruction** ✕

Skip        Comment:

▾

	Params	Register	Absolute
	final position	D20	Absolute
	final position	D22	Absolute
	begin speed	D8	
	end speed	D10	
	max speed	D12	
▶	axis 1	Y0	params
	axis 2	Y1	params

OK    Cancel

Instruction ② settings

G Instruction ✕

Skip  Comment:

LIN line VBEM

	Params	Register	Absolute
	final position	D30	Absolute
	final position	D32	Absolute
	begin speed	D8	
	end speed	D10	
	max speed	D12	
▶	axis 1	Y0	params
	axis 2	Y1	params

Instruction ③ settings

G Instruction ✕

Skip  Comment:

LIN line VBEM

	Params	Register	Absolute
	final position	D40	Absolute
	final position	D42	Absolute
	begin speed	D8	
	end speed	D10	
	max speed	D12	
▶	axis 1	Y0	params
	axis 2	Y1	params

Instruction ④ settings

Double-click the "parameters" to configure the parameters of Y0 and Y1 axis [pulse direction terminal], [group 2 parameters - pulse default speed (Hz)], [group 2 parameters - pulse default speed acceleration time (ms)], [group 2 parameters - pulse default speed deceleration time (ms)], as follows:

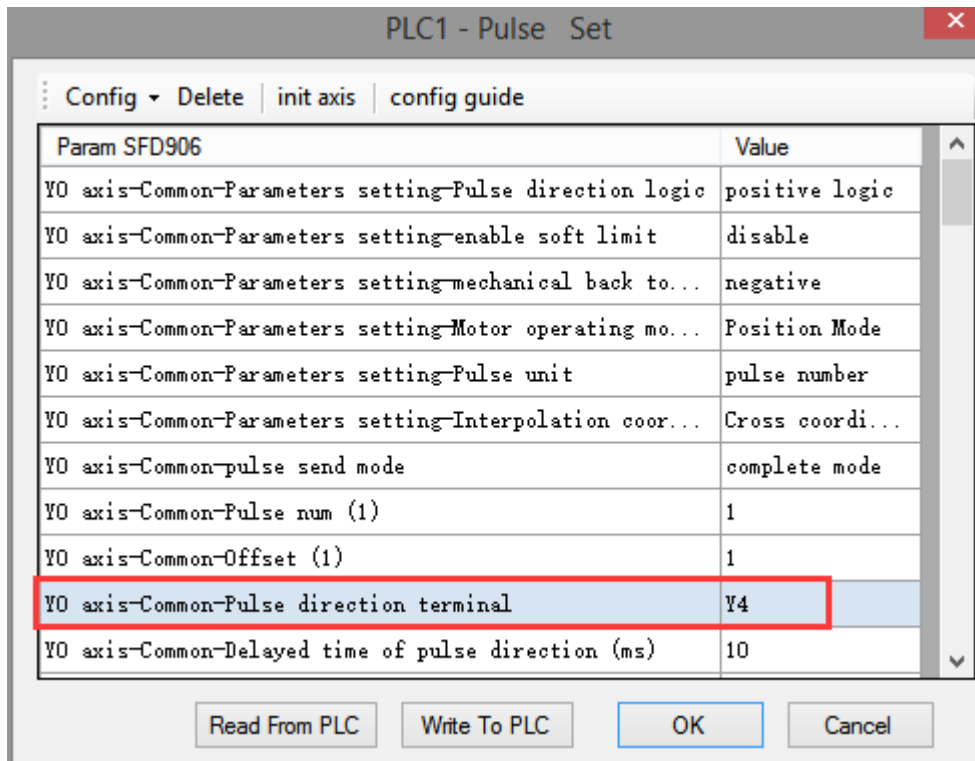

Y0 axis settings (1)

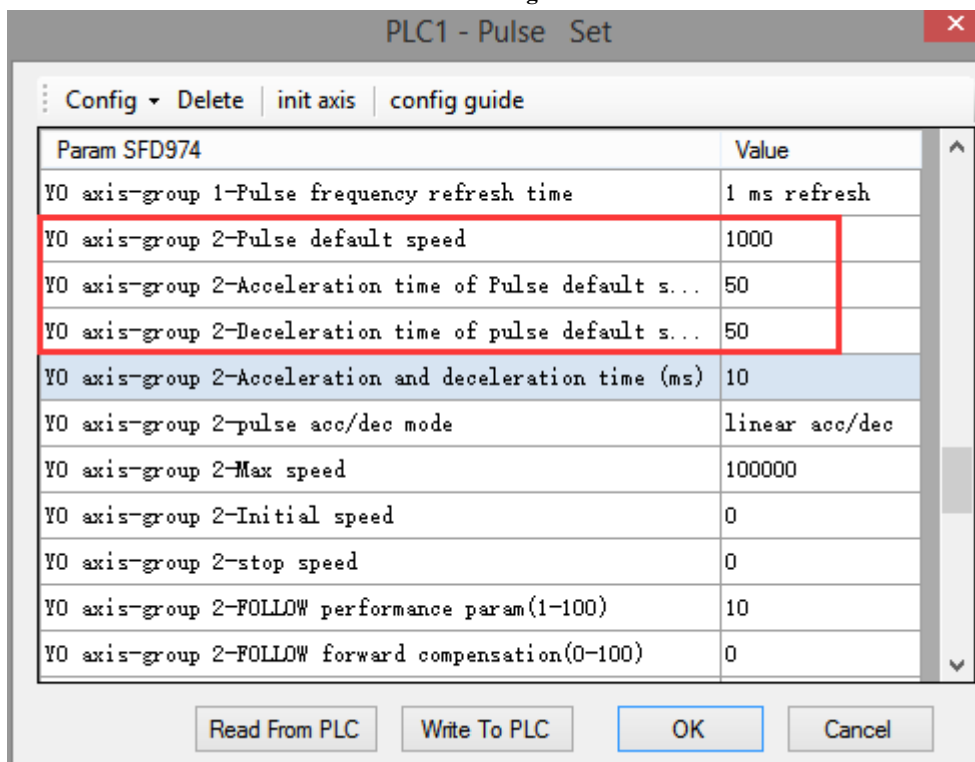

Y0 axis settings (2)

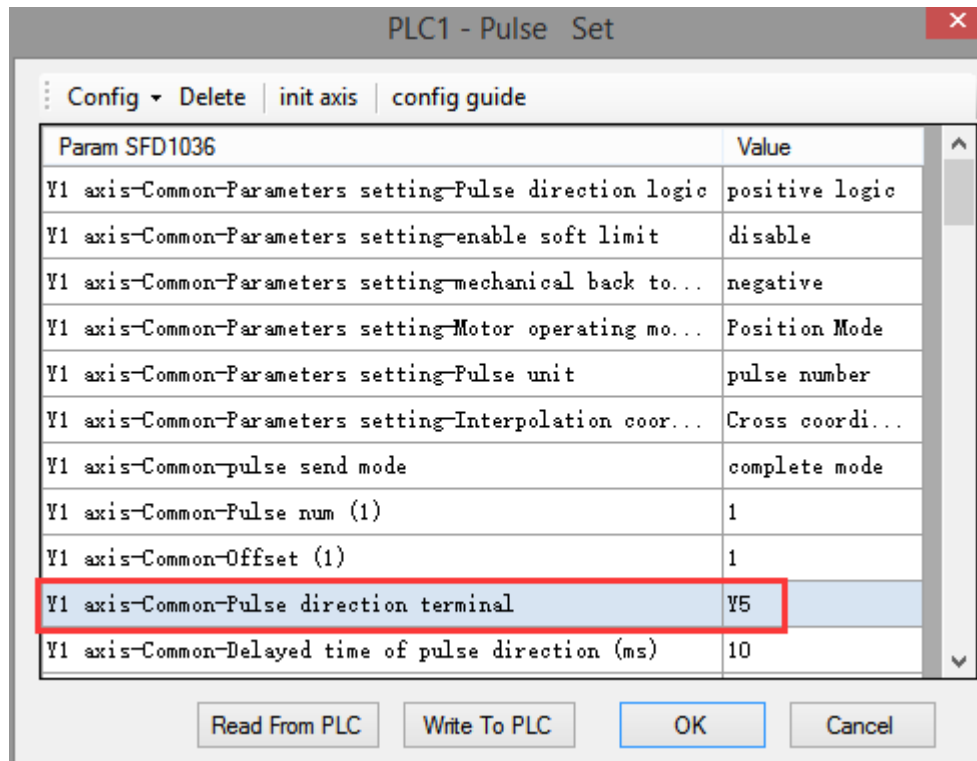

Y1 axis settings (1)

After setting up, click OK to generate the program shown in the following figure in the ladder diagram. Assuming that the current values of HSD2 (double-word) and HSD6 (double-word) are all 0, write the set values in the relevant registers. When M0 is turned on once, perform BLOCK once and take a triangle line once.

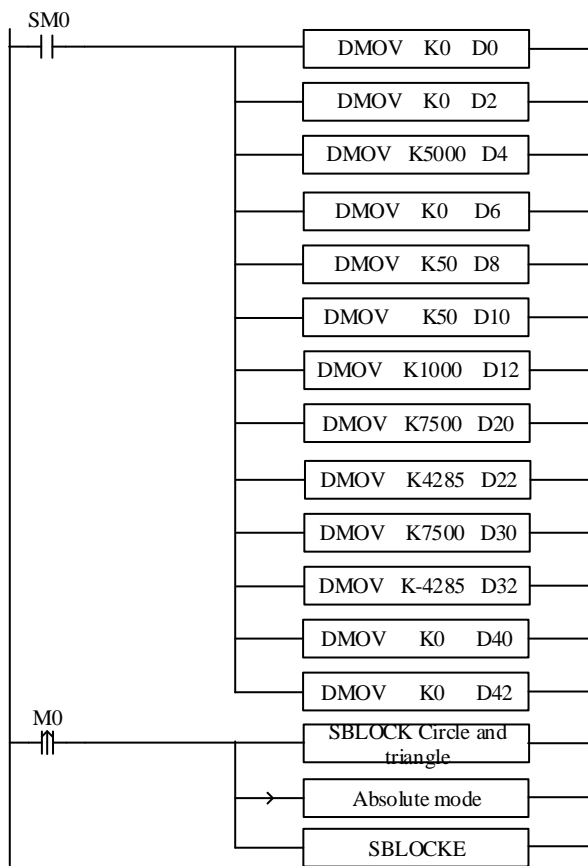
**Note:**

- (1) The current position pulses of the two axes can be monitored by HSD2 (double word) and HSD6 (double word).
- (2) The output terminals of the two axes correspond to Y0 and Y1 respectively, while the output terminals of the direction correspond to Y4 and Y5 respectively.
- (3) When there are many points to go (if there are 1000 points), the ladder chart we write according to the above method will be very long, which is not conducive to the optimization of the program; therefore, we can use HMI to modify the values in the linear interpolation register to execute multiple linear interpolation instructions, in order to improve the readability of the program, optimize and reduce the scanning cycle of the program. The coordinates of each point can be set in the power-off retention register (the setting value of HMI register can be set by recipe function).

### 2-6-3. Line + Arc symmetric figure

As shown in following figure: starting from origin A (0, 0), and pass point B→C→D→E→F→G→H→I→J→M→K→L→P→Q→W→Z→A, the figure is symmetric with Y axis, AB=5000, BC=3000, CD=6000, DE=4000, R2=3000, GH=6000, R1=7070.

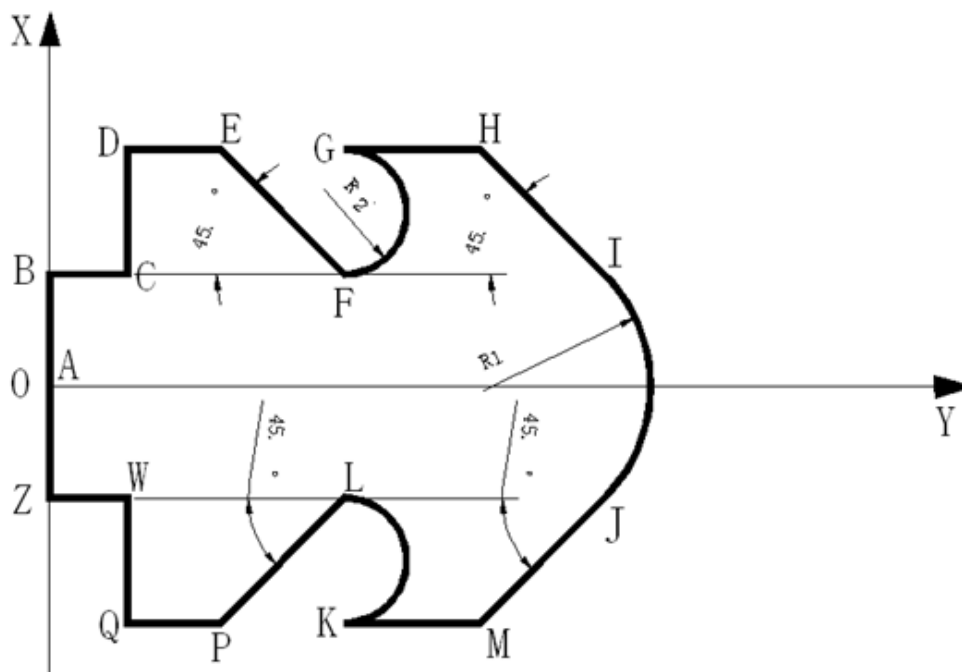

#### Note:

The two axes are designated as Y0 and Y1 axis, the corresponding directional terminals are Y4 and Y5, the default speed is 1000Hz, and the acceleration and deceleration time is 50ms, respectively. It is convenient to select the relative position mode according to the figure, so the specific parameters are set as follows:

Function	Address	Value (relative)	Function	Address	Value (relative)
B point coordinates	HD0	0	C point coordinates	HD4	3000
	HD2	5000		HD6	0
D point coordinates	HD8	0	E point coordinates	HD12	4000
	HD10	6000		HD14	0
F point coordinates	HD16	6000	G point coordinates	HD20	0
	HD18	-6000		HD22	6000
H point coordinates	HD24	6000	I point coordinates	HD28	6000
	HD26	0		HD30	-6000
J point coordinates	HD32	0	M point coordinates	HD36	-6000
	HD34	-10000		HD38	-6000
K point coordinates	HD40	-6000	L point coordinates	HD44	0
	HD42	0		HD46	6000
P point coordinates	HD48	-6000	Q point coordinates	HD52	-4000
	HD50	-6000		HD54	0

W point coordinates	HD56	0	Z point coordinates	HD60	-3000
	HD58	6000		HD62	0
A point coordinates	HD64	0	R2 radius	HD68	3000
	HD66	5000	R1 radius	HD70	7070
Default speed	1000Hz				
Acc/dec time	50ms				
X axis	Y0 pulse, Y4 direction				
Y axis	Y1 pulse, Y5 direction				

**Program (relative mode):**

Since the figure is mainly composed of straight lines and arcs, the "LIN line" instruction is chosen here, and the "CCW\_R anticlockwise arc" and "CW\_R clockwise arc" instruction are used for arcs. Insert G instruction into BLOCK and write 17 interpolation instructions, as shown in the following figure:

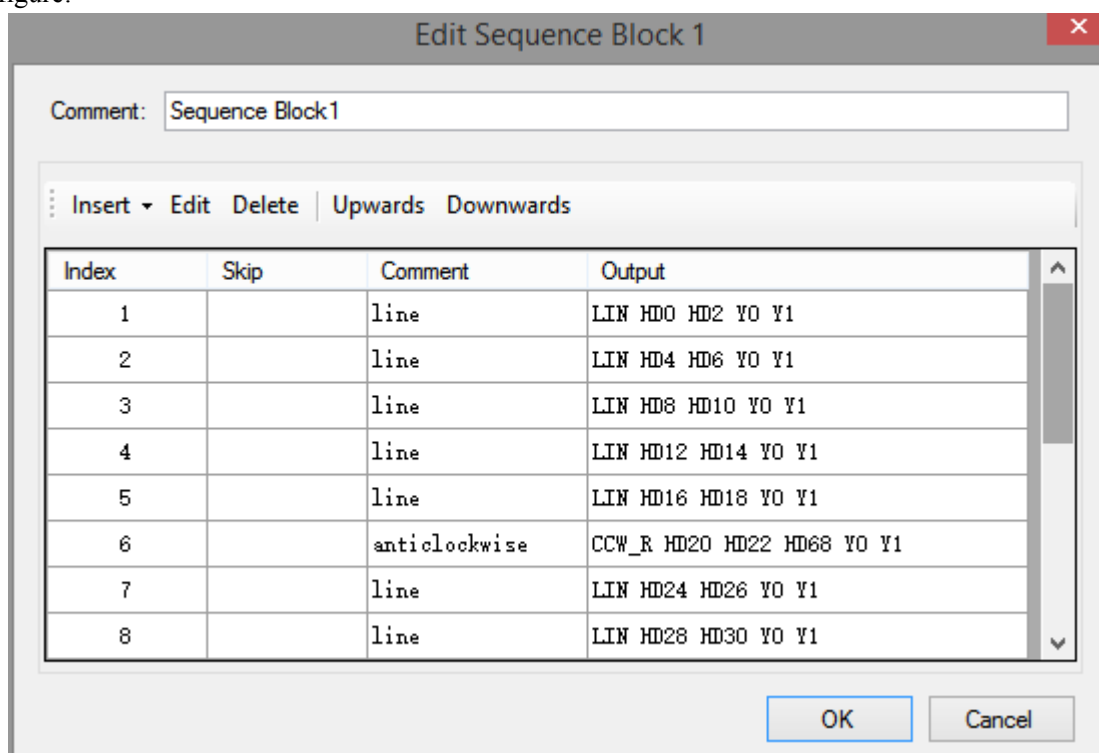

instruction (1) ~ (8)



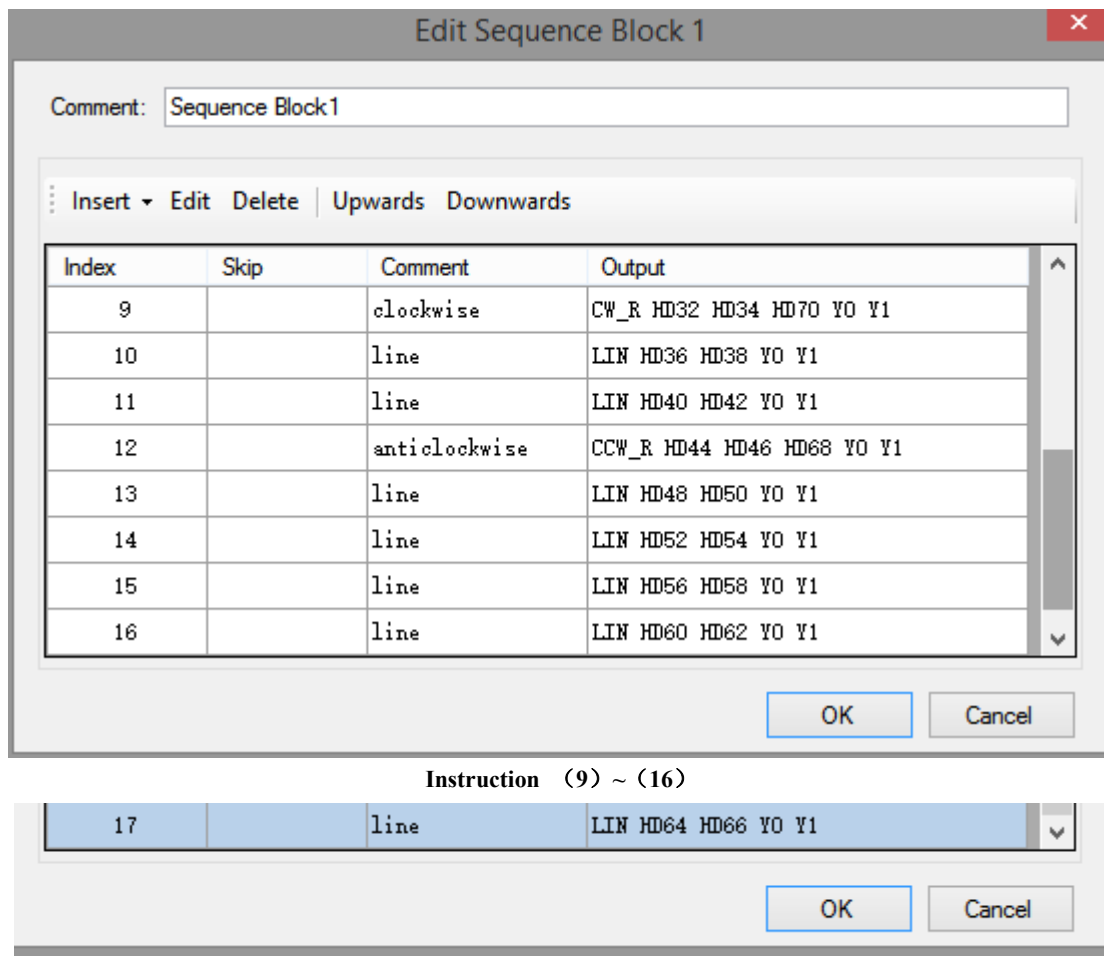

instruction (17)

The endpoint position of all the above instructions must be set to "relative mode", as shown in the following figure:

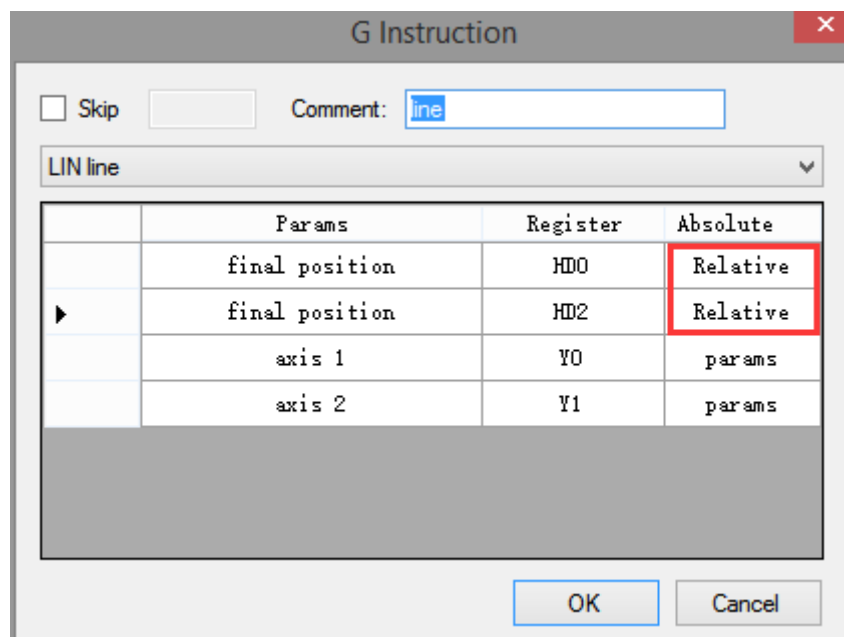

G Instruction ✕

Skip  Comment:

CCW\_R anticlockwise

	Params	Register	Absolute
	final position	HD20	Relative
▶	final position	HD22	Relative
	radius	HD68	
	axis 1	Y0	params
	axis 2	Y1	params

OK Cancel

G Instruction ✕

Skip  Comment:

CW\_R clockwise

	Params	Register	Absolute
	final position	HD32	Relative
▶	final position	HD34	Relative
	radius	HD70	
	axis 1	Y0	params
	axis 2	Y1	params

OK Cancel

**Note: The radius of the clockwise and anticlockwise arcs can only be absolute mode, and can not be modified!**

Double-click the "parameters" to configure the parameters of Y0 and Y1 axis [pulse direction terminal], [group 2 parameters - pulse default speed (Hz)], [group 2 parameters - pulse default speed acceleration time (ms)], [group 2 parameters - pulse default speed deceleration time (ms)], as follows:

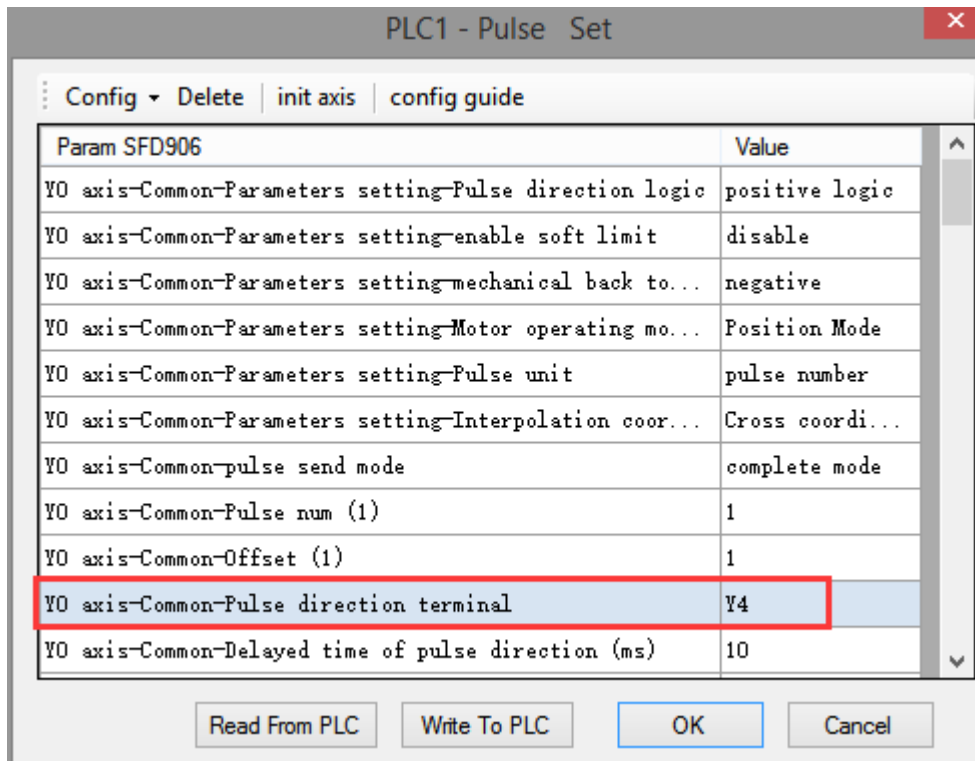

Y0 axis settings (1)

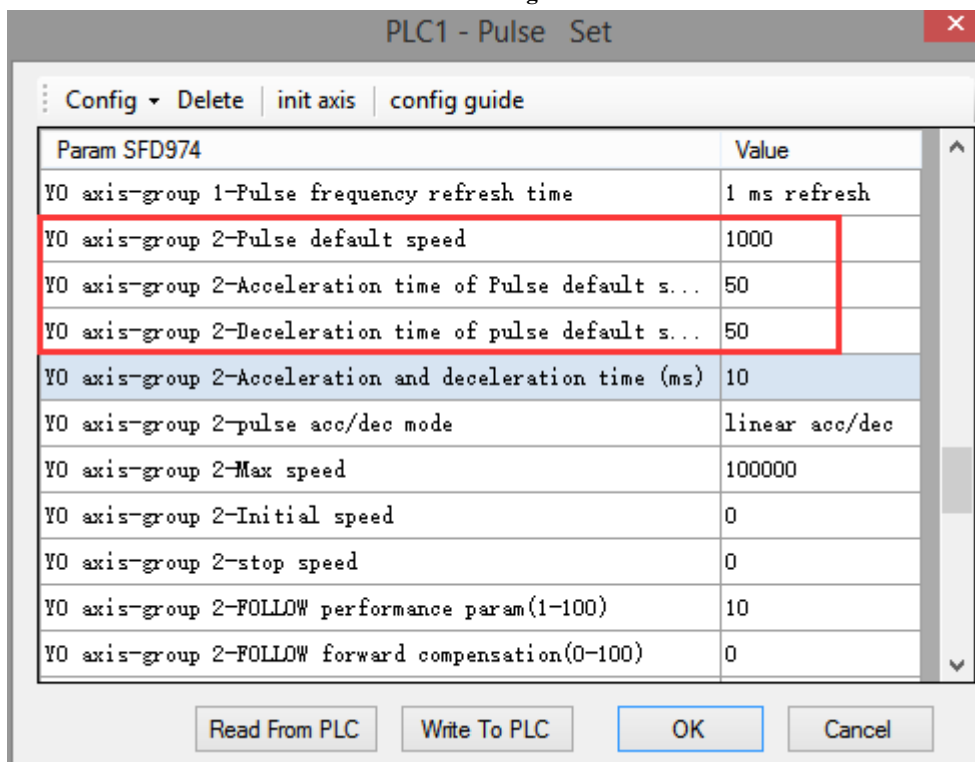

Y0 axis settings (2)

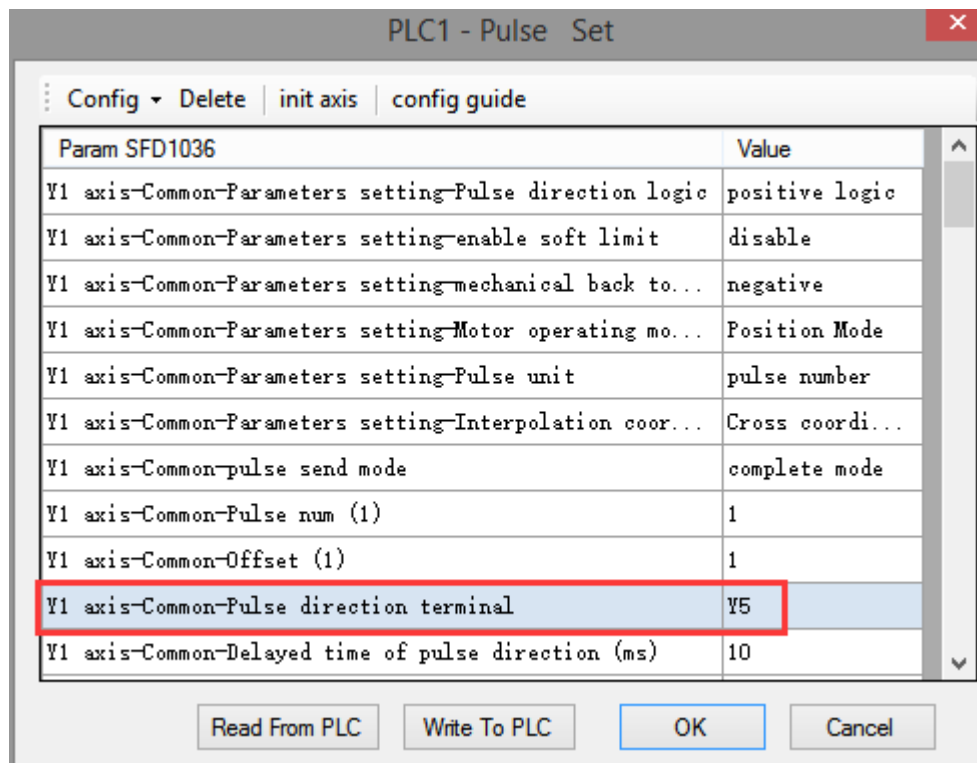

Y1 axis settings (1)

After setting up, click OK and write a complete program in the ladder diagram. As shown in the following figure, write the set value in the relevant register. When M0 is turned on once, execute BLOCK once, and walk the figure in this example once.

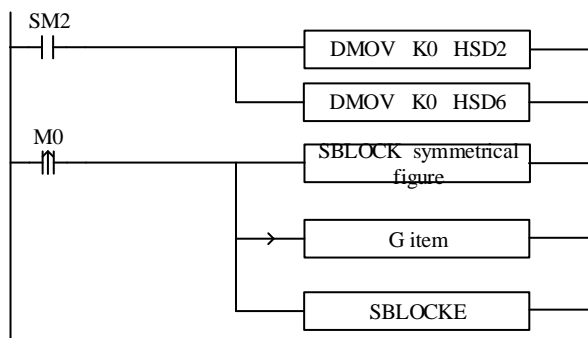
**Note:**

- (1) The current position pulses of the two axes can be monitored by HSD2 (double word) and HSD4 (double word).
- (2) The output terminals of the two axes correspond to Y0 and Y1 respectively, while the output terminals of the direction correspond to Y4 and Y5 respectively.

### 2-6-4. Disorder line segments

As shown in the figure, in the plane consisting of X-axis and Y-axis, the positioning of the equipment starts from the origin (0, 0), moves rapidly in the order of digital labeling (1-12) in the figure, and finally returns to the origin (0, 0) from the position of the 12th point (2000, 1350).

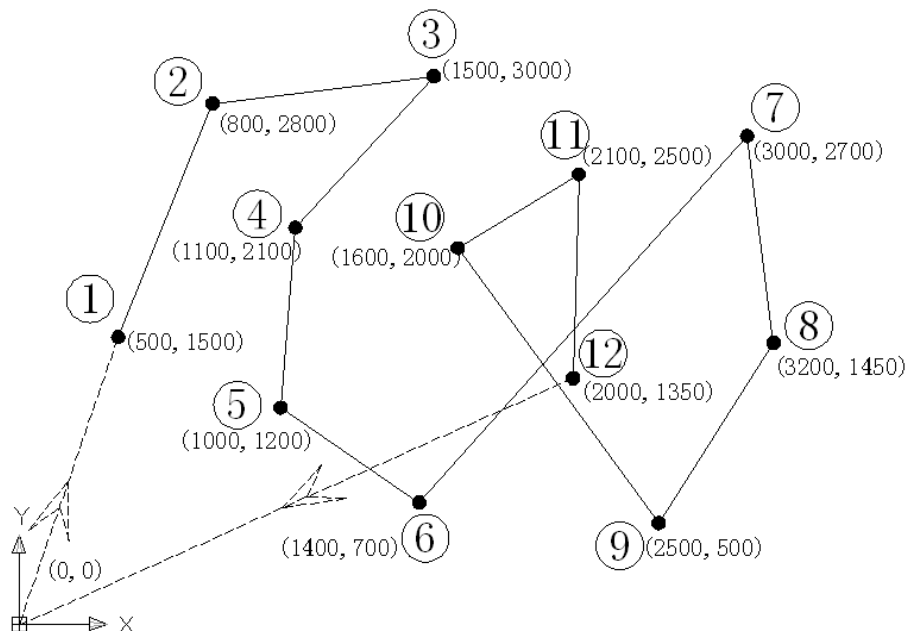

#### Note:

In this example, as the coordinates of each point are disorderly, so the lines connected sequentially by each point are slopes of arbitrary slope, so they can only be realized by the function of linear interpolation. From the graphics in the example, the coordinates of each point have been determined, so it is easier to choose absolute mode than relative mode.

The two axes are designated Y0 (X axis) and Y1 (Y axis), the corresponding direction terminals are Y4 and Y5, the default speed is 1000Hz, the acceleration and deceleration time is 50ms, and all coordinate points are in absolute mode. Therefore, the specific parameters are set as follows:

Point	X axis address	X axis setting value(absolute)	Y axis address	Y axis setting value(absolute)
Point 1	HD0	500	HD2	1500
Point 2	HD4	800	HD6	2800
Point 3	HD8	1500	HD10	3000
Point 4	HD12	1100	HD14	2100
Point 5	HD16	1000	HD18	1200
Point 6	HD20	1400	HD22	700
Point 7	HD24	3000	HD26	2700
Point 8	HD28	3200	HD30	1450
Point 9	HD32	2500	HD34	500
Point 10	HD36	1600	HD38	2000
Point 11	HD40	2100	HD42	2500

Point 12	HD44	2000	HD46	1350
Default speed (Hz)		1000		
Acc/dec time (ms)		50		
X axis		Y0-pulse; Y4-direction		
Y axis		Y1-pulse; Y5-direction		

**Program (absolute mode):**

Because the graphics are mainly composed of straight lines, the "LIN line" instruction is chosen here. Insert G instruction into BLOCK and write 12 interpolation instructions, as shown in the following figure:

The screenshot shows a software interface titled "Edit Sequence Block 1" with a comment field containing "Sequence Block1". Below the comment field are menu options: "Insert", "Edit", "Delete", "Upwards", and "Downwards". A table displays the first six instructions:

Index	Skip	Comment	Output
1		line	LIN HD0 HD2 YO Y1
2		line	LIN HD4 HD6 YO Y1
3		line	LIN HD8 HD10 YO Y1
4		line	LIN HD12 HD14 YO Y1
5		line	LIN HD16 HD18 YO Y1
6		line	LIN HD20 HD22 YO Y1

Instruction (1) ~ (6)

The screenshot shows the same software interface "Edit Sequence Block 1" with the comment "Sequence Block1". The table displays instructions 7 through 12, with the last row (index 12) highlighted in blue:

Index	Skip	Comment	Output
7		line	LIN HD24 HD26 YO Y1
8		line	LIN HD28 HD30 YO Y1
9		line	LIN HD32 HD34 YO Y1
10		line	LIN HD36 HD38 YO Y1
11		line	LIN HD40 HD42 YO Y1
12		line	LIN HD44 HD46 YO Y1

Instruction (7) ~ (12)

The endpoint position of all the above instructions must be set to "absolute mode", as shown in the following figure:

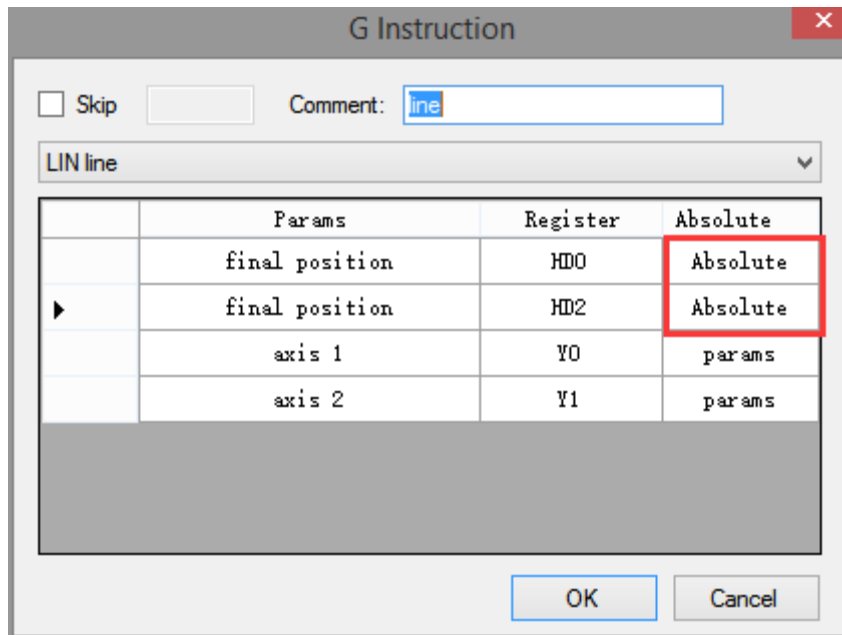

Double-click the "parameters" to configure the parameters of Y0 and Y1 axis [pulse direction terminal], [group 2 parameters - pulse default speed (Hz)], [group 2 parameters - pulse default speed acceleration time (ms)], [group 2 parameters - pulse default speed deceleration time (ms)], as follows:

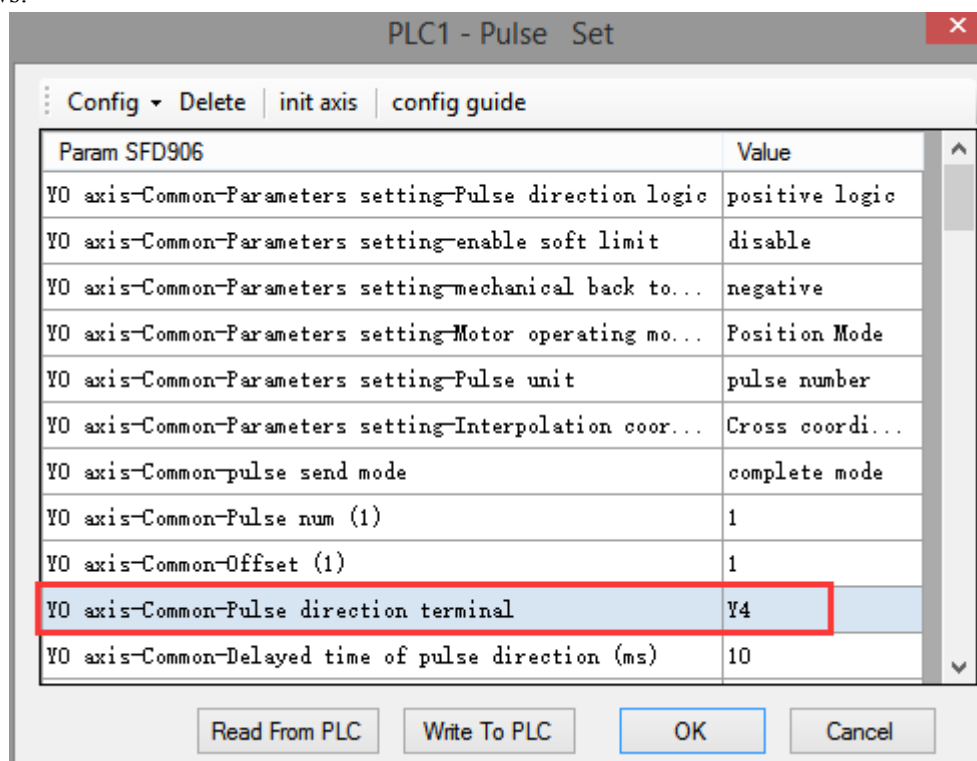

Y0 axis settings (1)

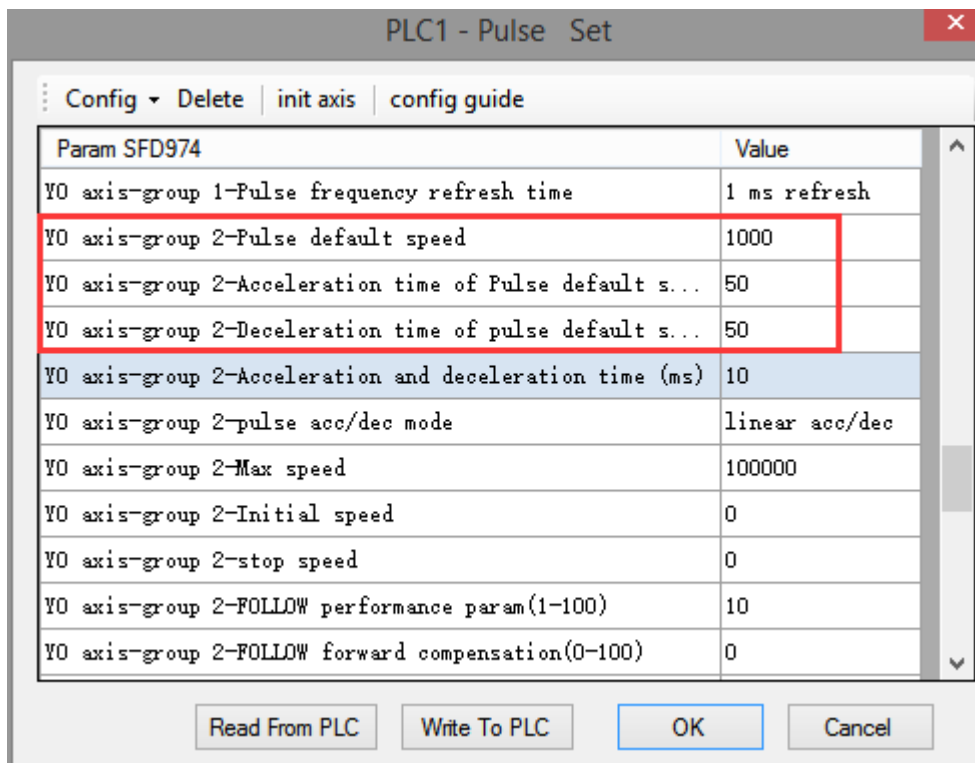

Y0 axis settings (2)

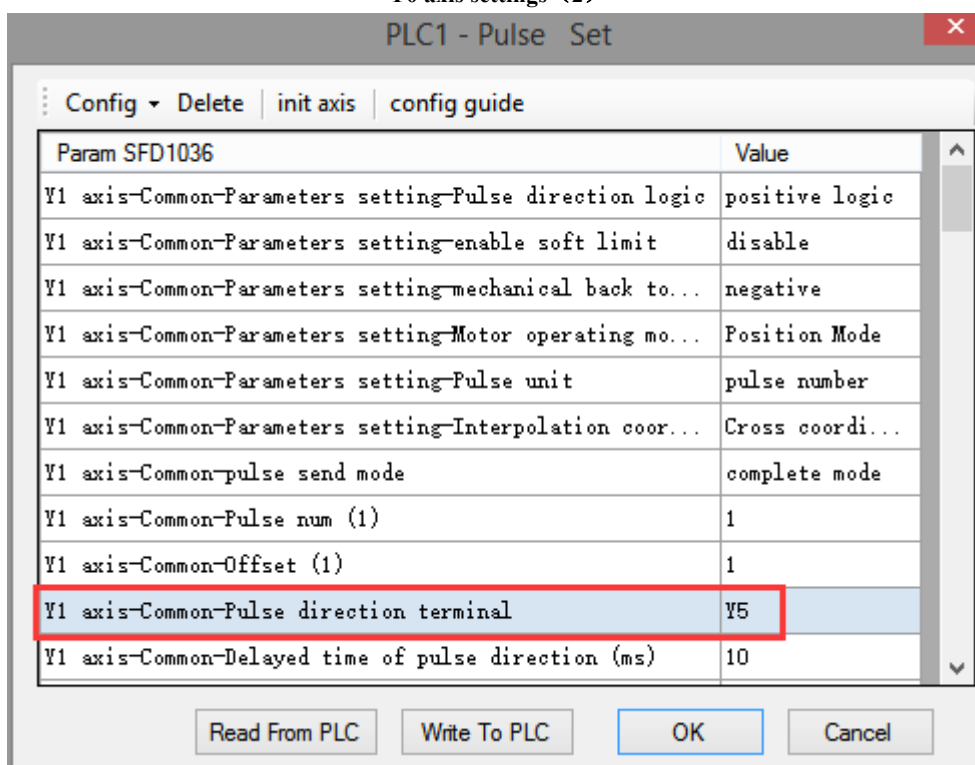

Y1 axis settings (1)



After setting up, click OK and write a complete program in the ladder diagram. As shown in the following figure, write the set value in the relevant register. When M0 is turned on once, execute BLOCK once, and walk the figure in this example once.

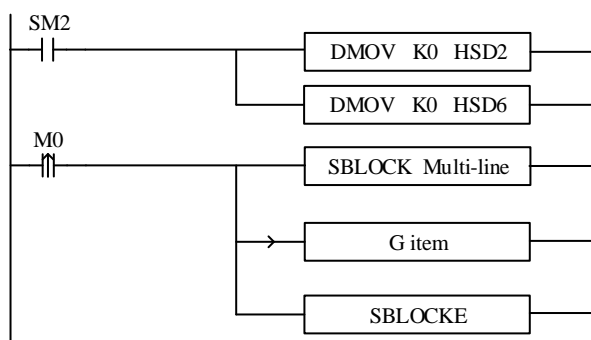

**Note:**

When there are many points to go (if there are 1000 points), the ladder chart we write according to the above method will be very long, which is not conducive to the optimization of the program; therefore, we can implement multiple linear interpolation instructions by modifying the values in the linear interpolation register to improve the readability, optimize and reduce the scanning cycle of the program. For example, the user can set the coordinates of each point in the power-off retentive register through the HMI, as shown in the following table:

Point	X axis register	X axis setting value	Y axis register	Y axis setting value
Point 1	D4000	500	D4100	1500
Point 2	D4002	800	D4102	2800
Point 3	D4004	1500	D4104	300
Point 4	D4006	1100	D4106	2100
Point 5	D4008	1000	D4108	200
Point 6	D4010	1400	D4110	700
Point 7	D4012	3000	D4112	2700
Point 8	D4014	3200	D4114	1450
Point 9	D4016	2500	D4116	500
Point 10	D4018	1600	D4118	2000
Point 11	D4020	2100	D4120	2500
Point 12	D4022	2000	D4122	1350

Note: HMI register setting value (can be set by HMI recipe function).

# 3 Application examples

In this chapter, some main instructions with more usage are introduced in depth in the form of program examples. These programs focus on pulse output instructions and motion control instructions.

## 3-1. Application of pulse output

Example: Now we are going to send three consecutive pulses, the pulse terminal is Y0 and the pulse direction terminal is Y2. The pulse frequency, pulse number and acceleration and deceleration of each segment are shown in the table below.

Pulse	Frequency setting value (Hz)	Pulse number setting value
Segment 1	3000	1000
Segment 2	800	2000
Segment 3	6000	8000
Acc/dec time	Frequency changes 1000Hz every 100ms	

Pulse data address assignment is as follows:

Address	Notes	Value
HD0 (double word)	Pulse total segments (1 to 100)	3
HD2 (8 words)	Reserved	0
HD10 (double words)	Pulse frequency (#1)	3000
HD12 (double word)	Pulse number (#1)	1000
HD14	bit15~bit8: waiting condition (#1) H00: pulse sending completion H01: wait time H02: wait signal H03: ACT time H04: EXT signal H05: EXT signal or pulse sending completion bit7~bit0: waiting condition register type H00: constant H01: D	0

	H02: HD H03: FD H04: X H05: M H06: HM	
HD15 (double word)	Constant value/ register no. (for waiting condition)(#1)	0
HD17	bit7~bit0: jump register type H00: constant value H01: D H02: HD H03: FD	0
HD+18 (double word)	Constant value/register no. (for jump register)( #1)	0
HD+20 (double word)	Pulse frequency (#2)	800
HD+22 (double word)	Pulse number (#2)	2000
HD+24	Waiting condition, waiting condition register type (#2)	0
HD+25 (double word)	Constant value or register no. (for waiting condition) (#2)	0
HD+27	Jump type, jump register type (#2)	0
HD+28 (double word)	Constant value or register no. (for jump register) (#2)	0
HD+30 (double word)	Pulse frequency (#3)	6000
HD+32 (double word)	Pulse number (#3)	8000
HD+34	Waiting condition, waiting condition register type (#3)	0
HD+35 (double word)	Constant value or register no. (for waiting condition) (#3)	0
HD+37	Jump type, jump register type (for waiting condition) (#3)	0
HD+38 (double word)	Constant value or register no. (for jump register) (#3)	0

System parameters

SFD900	Pulse parameter setting	<p>Bit 1: pulse direction logic 0: positive logic 1: negative logic, default is 0</p> <p>Bit 2: use soft limit function 0: not use 1: use default is 0</p> <p>Bit 3: mechanical return to origin direction 0: negative direction 1: positive direction default is 0</p> <p>Bit 10~8: pulse unit Bit8: 0: pulse number 1: equivalent 000: pulse number 001: 1 um 011: 0.01mm 101: 0.1mm 111: 1 mm Default is 000</p> <p>Bit15: interpolation coordinate mode 0: cross coordinate 1: polar coordinate Default is 0</p>	0	Common parameter
SFD901	Pulse sending mode	<p>Bit 0: pulse sending mode 0: complete mode 1: subsequence mode, default is 0</p>	0	
SFD902	Pulse number/1 rotation low 16 bits		0	
SFD903	Pulse number/1 rotation high 16 bits		0	
SFD904	Motion quantity/1 rotation low 16 bits		0	
SFD905	Motion quantity/1 rotation high 16 bits		0	
SFD906	Pulse direction terminal	Y terminal no., 0xFF is no terminal	2	
SFD907	Direction delay time	Default is 20, unit: ms	20	
SFD908	Gear clearance positive compensation		0	
SFD909	Gear clearance negative compensation		0	
SFD910	Electrical origin low 16 bits		0	
SFD911	Electrical origin high 16 bits		0	

SFD912	Signal terminal state setting	Bit0: origin signal switch state Bit1: Z phase switch state Bit2: positive limit switch state Bit3: negative limit switch state 0: normally open(positive logic) 1: normally close(negative logic) default is 0	0	
SFD913	Close point signal	Bit0~bit7: set X terminal, 0xFF is no terminal(interruption)	0xFF	
SFD914	Z phase terminal setting	Bit0~bit7: set X terminal, 0xFF is no terminal(interruption)	0xFF	
SFD915	Limit terminal setting	Bit7~bit0: X terminal of positive limit, 0xFF is no terminal Bit15~bit8: X terminal of negative limit, 0xFF is no terminal	FFFF	
SFD917	Clear signal CLR output terminal	Bit0~Bit7: Y terminal, 0xFF is no terminal	0xFF	
SFD918	Returning speed VH low 16 bits		0	
SFD919	Returning speed VH high 16 bits		0	
SFD922	Crawling speed VC low 16 bits		0	
SFD923	Crawling speed VC high 16 bits		0	
SFD924	Mechanical origin position low 16 bits		0	
SFD925	Mechanical origin position high 16 bits		0	
SFD926	Z phase numbers		0	
SFD927	CLR signal delay time	Default 20, unit: ms	20	
SFD928	Grinding wheel radius(polar coordinate)	Low 16 bits	0	
SFD929		High 16 bits	0	
SFD930	Soft limit positive limit value	Low 16 bits	0	
SFD931		High 16 bits	0	
SFD932	Soft limit negative limit value	Low 16 bits	0	
SFD933		High 16 bits	0	
...				
SFD950	Pulse default speed low 16 bits	It will send pulse with default speed when the speed is 0.	1000	Group 1
SFD951	Pulse default speed high 16 bits		0	

SFD952	Pulse default speed acceleration time		100
SFD953	Pulse default speed deceleration time		100
SFD954	Acceleration and deceleration time		0
SFD955	Pulse acceleration and deceleration mode	Bit 1~0: acc/dec mode 00: line 01: S curve 10: sine curve 11: reserved Bit 15~2: reserved	
SFD956	Max speed limit low 16 bits		3392
SFD957	Max speed limit high 16 bits		3
SFD958	Initial speed low 16 bits		0
SFD959	Initial speed high 16 bits		0
SFD960	Stop speed low 16 bits		0
SFD961	Stop speed high 16 bits		0
SFD962	Follow performance parameters	1~100, 100 means the time constant is one tick, 1 means the time constant is 100 tick.	
SFD963	Follow feedforward compensation	0~100, percentage	
...			

**Pulse instruction:**

**Software configurations:**

## ➤ Pulse configuration

multi section pulse output

data start address: HD0 user params address: HD100 system params: K1 output: Y0

mode: relative start execute section count: 0 Config

Add Delete Upwards Downwards

	frequency	pulse count	wait condition	wait register	jump register
1	3000	1000	pulse sending complete	K0	K0
2	800	2000	pulse sending complete	K0	K0
▶ 3	6000	8000	pulse sending complete	K0	K0

used space: HD0-HD39,HD100-HD103

Read From PLC Write To PLC OK Cancel

## ➤ Pulse system parameters

PLC1 - Pulse Set

Config Delete init axis config guide

Param SFD906	Value
Y0 axis-Common-Parameters setting-Pulse direction logic	positive logic
Y0 axis-Common-Parameters setting-enable soft limit	disable
Y0 axis-Common-Parameters setting-mechanical back to...	negative
Y0 axis-Common-Parameters setting-Motor operating mo...	Position Mode
Y0 axis-Common-Parameters setting-Pulse unit	pulse number
Y0 axis-Common-Parameters setting-Interpolation coor...	Cross coordi...
Y0 axis-Common-pulse send mode	complete mode
Y0 axis-Common-Pulse num (1)	1
Y0 axis-Common-Offset (1)	1
Y0 axis-Common-Pulse direction terminal	Y2
Y0 axis-Common-Delayed time of pulse direction (ms)	10

Read From PLC Write To PLC OK Cancel

PLC1 - Pulse Set

Config ▾ Delete | init axis | config guide

Param SFD906	Value
Y0 axis-Common-Gear clearance positive compensation	0
Y0 axis-Common-Gear clearance negative compensation	0
Y0 axis-Common-Electrical origin position	0
Y0 axis-Common-signal terminal switch state setting...	normally on
Y0 axis-Common-signal terminal switch state setting...	normally on
Y0 axis-Common-signal terminal switch state setting...	normally on
Y0 axis-Common-signal terminal switch state setting...	normally on
Y0 axis-Common-Far-point signal terminal setting	X no terminal
Y0 axis-Common-Z phase terminal setting	X no terminal
Y0 axis-Common-positive limit terminal setting	X no terminal
Y0 axis-Common-negative limit terminal setting	X no terminal

Read From PLC Write To PLC OK Cancel

PLC1 - Pulse Set

Config ▾ Delete | init axis | config guide

Param SFD924(dword)	Value
Y0 axis-Common-positive limit terminal setting	X no terminal
Y0 axis-Common-negative limit terminal setting	X no terminal
Y0 axis-Common-Zero clear CLR output setting	Y no terminal
Y0 axis-Common-Return speed VH	0
Y0 axis-Common-Creeping speed VC	0
Y0 axis-Common-Mechanical zero position	0
Y0 axis-Common-Z phase num	0
Y0 axis-Common-CLR signal delayed time (ms)	20
Y0 axis-Common-grinding wheel radius(polar Interpola...	0
Y0 axis-Common-soft limit positive value	0
Y0 axis-Common-soft limit negative value	0

Read From PLC Write To PLC OK Cancel



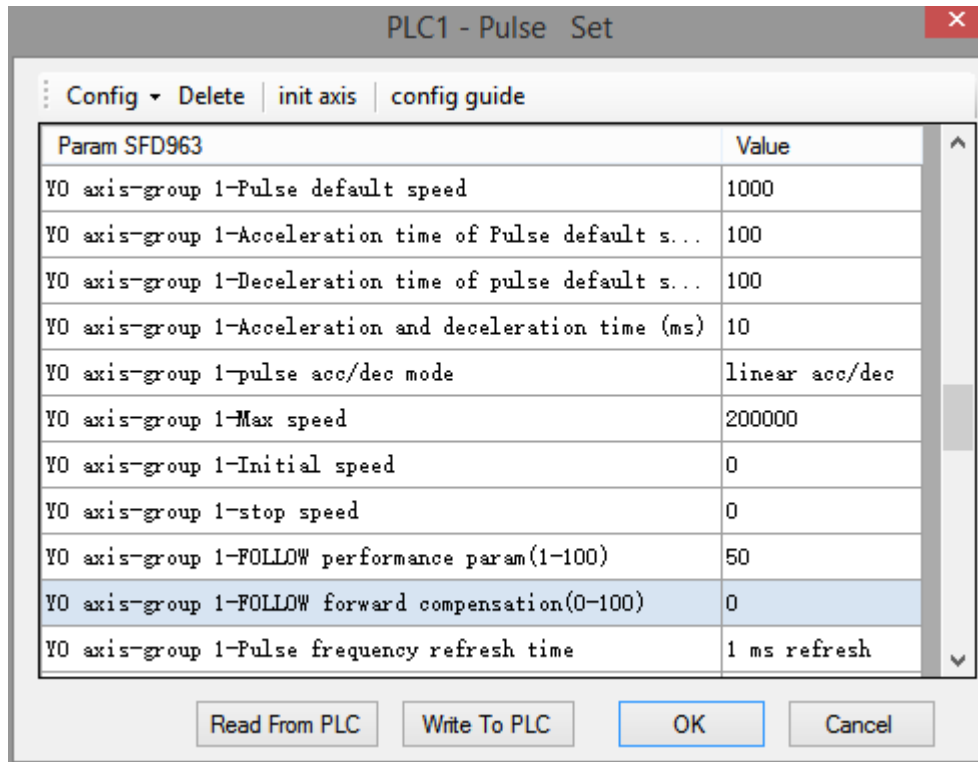

➤ Pulse sending oscillogram

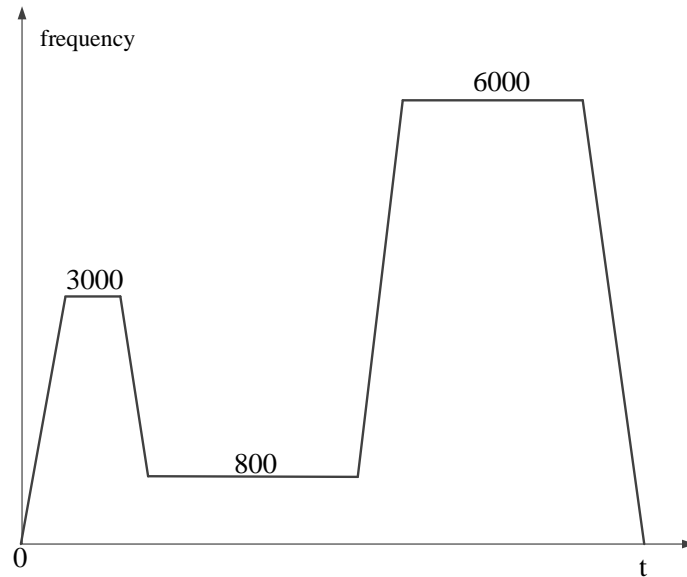

## 3-2. Application of motion control in arc saw machining system

### 1. Introduction of arc saw technology

The arc saw is a machine used to cut arc boards. The mechanical characteristics are that the arc radius is large and the motor load is large.

### 2. Products applied in this system

Product name	Model	Number
PLC	XDM-32T4-E	1
HMI	OP320-A	1
Stepper driver	DP-21P5	2

### 3. Composition of control system

#### (1) The composition of system hardware

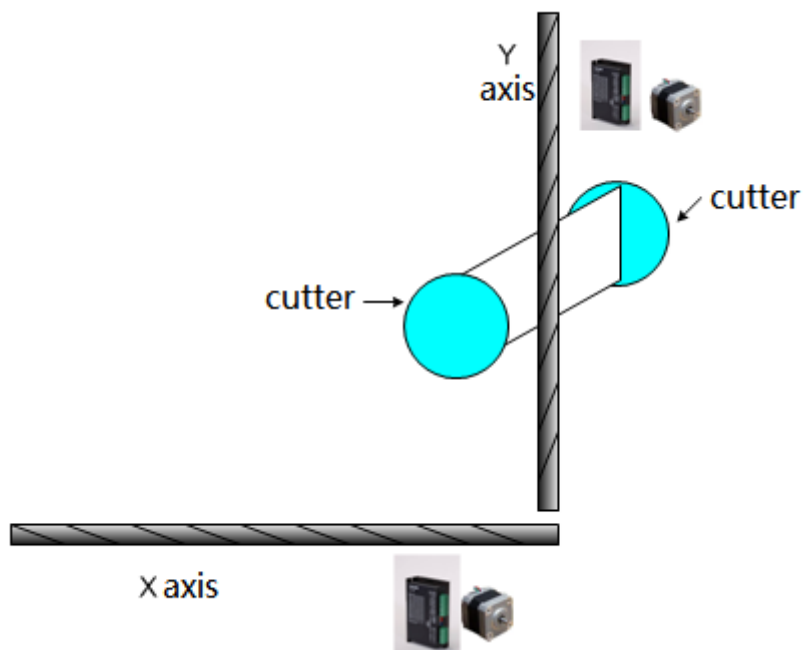

As shown in the figure, two stepper motors control X and Y axis respectively, and use the arc interpolation instruction of XINJE XDM PLC to make X and Y axis coordinate and get out of the circular arc track. The relative distance of the cutter installed on the workbench determines the width of the plate cut by the cutter.

#### (2) Technical difficulties

- The processing arc radius is large, the pitch of the XY axis screw is large, the number of pulse and the amount of movement are difficult to configure, if the setting is not appropriate, the data calculation is easy to overflow.
- Due to the heavy load of the motor, it is easy to lose step or overshoot.

- The speed of returning to the mechanical origin should not be too fast.
- Owing to the ellipse of the processed arc board, the ellipse can not be cut directly by arc interpolation, otherwise the board can not be sawn through.

### (3) Control scheme

This scheme adopts the motion-controlled PLC XDM, which has high-speed command operation, built-in four 100KHz high-speed pulse output, support motion control command arc interpolation, RS232, RS485 serial ports, convenient for various upper computer monitoring, powerful external interrupt function, greatly saves the electrical cost for customers.

In view of the above difficulties, we adopt the method of reducing the ratio of the number of pulses and the amount of movement to reduce the calculation value and prevent the calculation overflow. (For example, the number of pulses is 2400 and the amount of movement is 10000. When setting parameters, the amount of movement is reduced by 10 times to 1000, so the number of pulses per unit is increased by 10 times. When setting physical quantities, we will reduce by 10 times accordingly. For example, when setting 1000 millimeters, we only need to set 100 in the corresponding registers.) In order to ensure that the motor is not out of step or overshoot, it is necessary to set the acceleration and deceleration time a little longer and increase the driver current (note that the motor is easy to heat if the current is too large). Before the arc interpolation, the straight line cutting is carried out, and then the arc cutting is carried out, which solves the problem that the direct arc cutting can not be cut through.

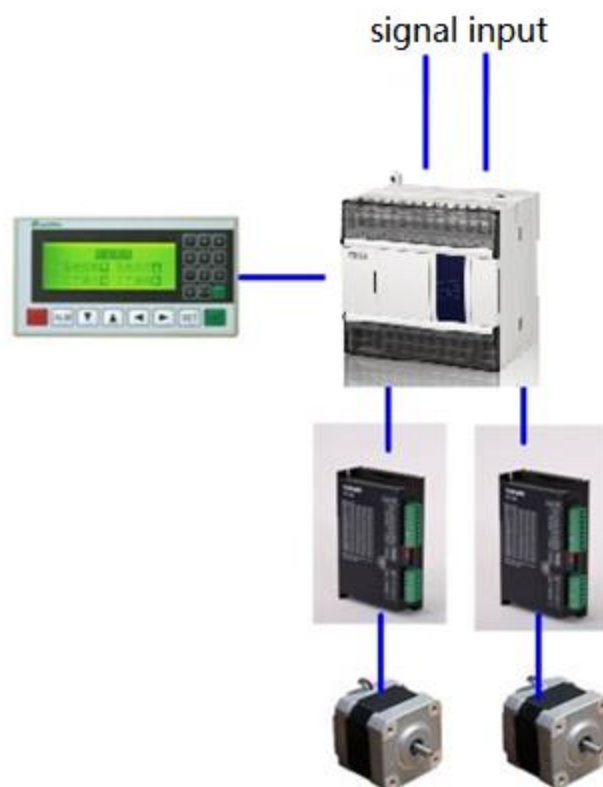

In positioning motion control, returning to mechanical origin is very important for control accuracy. However, some mechanical motors have a large load and only one origin signal. The control object is a stepper motor. There is no Z-phase signal output, and the requirement of

returning to the origin is fast. In this case, we use the ZRN instruction in XD to configure the internal acceleration and deceleration time settings. The problem has been solved.

(4) The operation diagram of the interpolation instructions in the system is as follows:

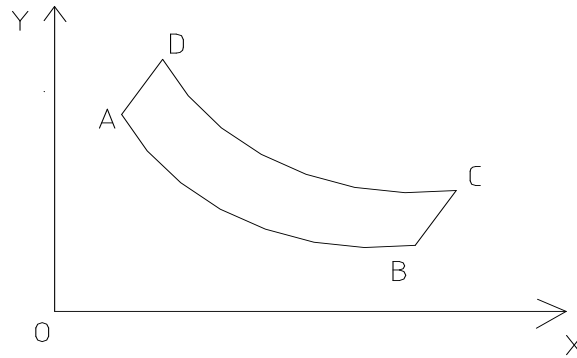

The coordinates of the points in the figure are as follows: O(HD0, HD2), A(HD4, HD6), B(HD8, HD10), C(HD12, HD14), C(HD16, HD18), the midpoint coordinates of the AB arc are (HD20, HD22), the midpoint coordinates of the CD arc are (HD24, HD26).

Motion path: O→A→B→C→D→A→O.

5. The interpolation instructions in the system are as follows:

Index	Skip	Comment	Output
1	OA	fast position	DRV HD4 HD6 YO Y1
2	AB	three point	ARC HD8 HD10 HD20 HD22 YO Y1
3	BC	line	LIN HD12 HD14 YO Y1
4	CD	three point	ARC HD16 HD18 HD24 HD26 YO Y1
5	DA	line	LIN HD4 HD6 YO Y1
6	AO	fast position	DRV HD0 HD2 YO Y1

### 3-3. Application of motion control in hair planting machine

#### 1. Process introduction

At present, the electric control system structure of hair planting machine is mainly divided into single chip computer control system or CNC numerical control system. Among them, the single-chip computer control system is based on the integrated service of automation system manufacturer, supplemented by the independent research and development of toothbrush equipment manufacturer.

The drive structure of high-speed toothbrush hair planter is composed of main drive shaft and four servo drive shaft systems. The four servo axes are horizontal X-axis, vertical Y-axis, hair changing Z-axis and rotary A-axis. The position of the toothbrush hole is determined by the coordinates of the XY two axes. The A axis play the role of replacing the next toothbrush and the Z axis play the role of replacing the brush color. When the main shaft motor (frequency converter control) runs, the four electronically controlled servo shafts will run, while the other four shafts will stop when the main shaft stops. The speed of the main axis determines the speed of hair planting. The response of the four servo shafts need coordinated driving, otherwise, hair removal or hair irregularity will occur.

#### 2. the products required in the application

Product name	Model	Quantity
PLC	XDM-60T4-E	1
Extension module	XD-E2DA	1
HMI	TG865-MT (U)	1
Servo drive	DS3-20P7-PQA	3
Servo drive	DS3-20P4-PQA	1

#### 3. Composition of Control System

##### (1) The Composition of System Hardware

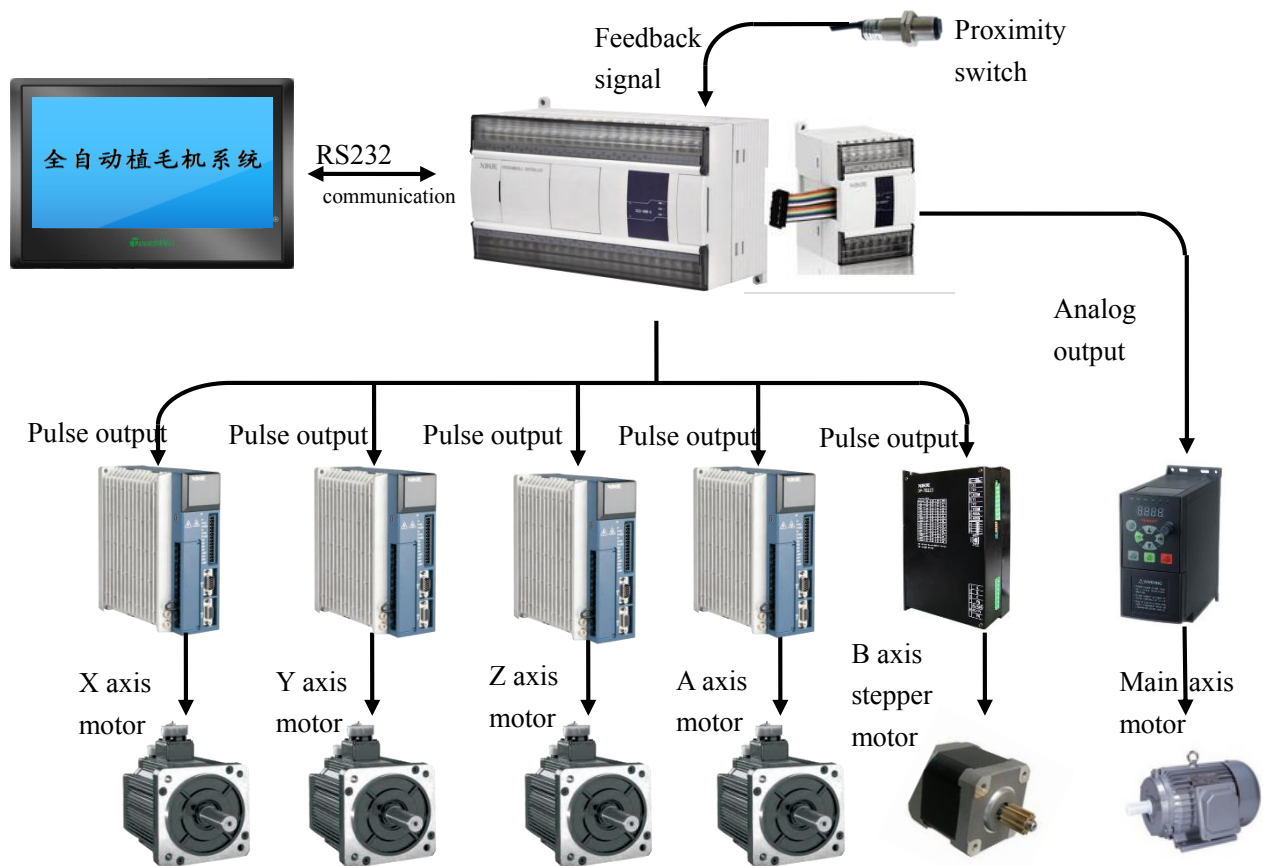

## (2) Finished toothbrush products



## (3) Technological difficulties

The difficulty of developing servo solution is the joint debugging of electromechanical system, in which the adjustment of servo gain and the cooperation of PLC triangular function curve are the main problems. Among the four servo shafts, the mechanical inertia of X-axis and Y-axis is relatively stable due to the screw drive structure, and it is easy to debug, so it is possible to modify the speed gain. The Z-axis of the turning plate is a rotating axis. There is centrifugal force in high-speed rotation. If the gain of the turning plate is set very high, the motor will vibrate when it starts and stops. At this time, the position filtering time parameters can be modified to eliminate

the vibration. Comparatively speaking, the structure of cam mechanism for changing hair U-axis makes debugging more difficult. In addition, the mechanical rigidity of U-axis is not good. When the motor runs, the inertia ratio varies greatly, the output current of the motor varies greatly, and the parameters can not be adjusted properly. When the motor runs around, the shaft either vibrates or screams, or reacts slowly. When the parameters are adjusted, the gain of the speed loop and the filtering time parameters and position loop gain need to be adjusted accordingly.

#### (4) Control solution

Mainly control axis pulse command signal to achieve servo drive, usually four-axis control output. The motion control type of PLC XDM-60T4-E is chosen. It has a response speed of 0.1ms and four high-speed pulses, which can realize the two-axis interpolation operation required by the toothbrush hair planter. The four sets of servo drivers are DS3 series AC servo system with power of 400W~750W. The driver has many functions, such as strong overload ability, strong anti-load disturbance ability, large starting moment, high dynamic response speed and short positioning time. The main axis motor frequency converter model is Xinje VB5N series, the power is 400 W.

#### (5) action order

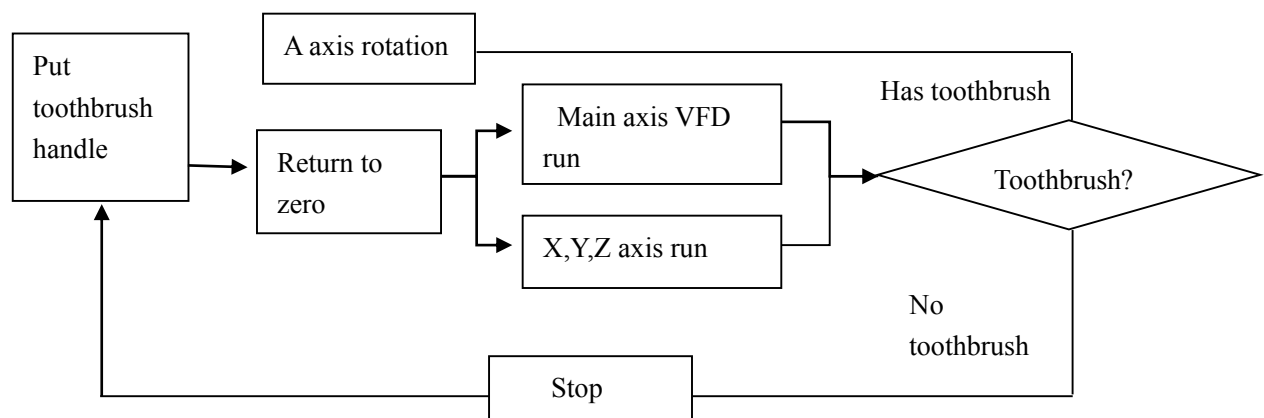

Action process: The clip holds the toothbrush handle from Y axis direction → 90 degrees positioning to Z axis direction → platform drives the clip to do X Y axis movement enables the brush hair to be hit into the hole of the toothbrush head → hair planting completes, the clip rotates downward 90 degrees → the clip loosens, and a toothbrush is produced. The application of Xinje XDM series PLC and DS5 servo system can achieve 900 times/minute hair planting speed. And at the same time of high-speed start and stop, the stability and softness of the overall movement is particularly prominent. Through the application of self-made pulse S curve in PLC, we can achieve hole skipping hair planting. When skipping, the machine is almost as smooth as usual without obvious jitter while ensuring the accuracy of skipping.

**4. The operation diagram of the interpolation instructions in the system is as follows.**

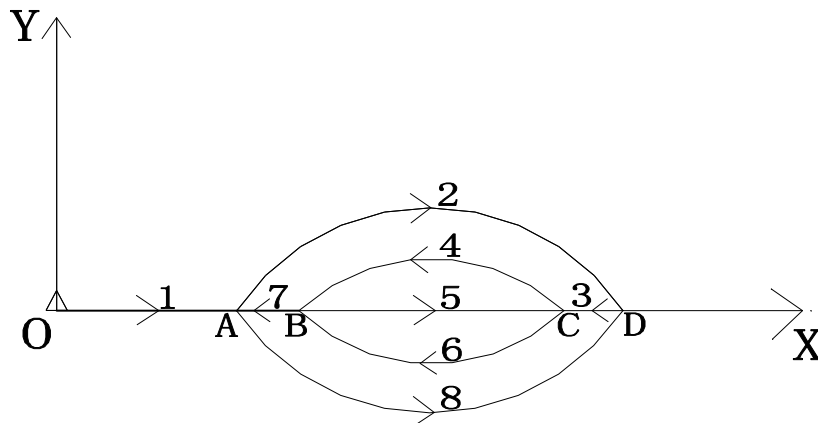

The coordinates of the points in the figure are as follows: O (HD0, HD2), A (HD4, HD6), B (HD8, HD10), C (HD12, HD14), D (HD16, HD18), the midpoint coordinates of the clockwise arc of AD segment (HD20, HD22), the midpoint coordinates of the anticlockwise arc of AD segment (HD32, HD34), the midpoint coordinates of the clockwise arc of BC segment (HD28, HD30), and the midpoint coordinates of the anticlockwise arc of BC segment (HD24, HD26). Path of particle:  $O \rightarrow A \rightarrow D \rightarrow C \rightarrow B \rightarrow C \rightarrow B \rightarrow A \rightarrow D \rightarrow O$ .

### 5. The interpolation instructions in the system.

Index	Skip	Comment	Output
1		fast position	DRV HD4 HD6 YO Y1
2		three point	ARC HD16 HD18 HD20 HD22 YO Y1
3		line	LIN HD12 HD14 YO Y1
4		three point	ARC HD8 HD10 HD24 HD26 YO Y1
5		line	LIN HD12 HD14 YO Y1
6		three point	ARC HD8 HD10 HD28 HD30 YO Y1
7		line	LIN HD4 HD6 YO Y1
8		three point	ARC HD16 HD18 HD32 HD34 YO Y1



Edit Sequence Block 1

Comment: Sequence Block1

Insert Edit Delete Upwards Downwards

Index	Skip	Comment	Output
2		three point	ARC HD16 HD18 HD20 HD22 YO Y1
3		line	LIN HD12 HD14 YO Y1
4		three point	ARC HD8 HD10 HD24 HD26 YO Y1
5		line	LIN HD12 HD14 YO Y1
6		three point	ARC HD8 HD10 HD28 HD30 YO Y1
7		line	LIN HD4 HD6 YO Y1
8		three point	ARC HD16 HD18 HD32 HD34 YO Y1
9		line	LIN HD0 HD2 YO Y1

OK Cancel

# Appendix Special soft element list

Appendix mainly introduces the functions of XD/XL series PLC special soft element, data register, FlashROM and the address distribution of expansions for users to search.

## Appendix 1. Special auxiliary relay

### Initial Status (SM0-SM7)

ID	Function	Description	
SM000	Coil ON when running		SM000 keeps ON when PLC running
SM001	Coil OFF when running		SM001 keeps OFF when PLC running
SM002	Initial positive pulse coil		SM002 is ON in first scan cycle
SM003	Initial negative pulse coil		SM003 is OFF in first scan cycle
SM004	PLC running error	When SM4 sets ON, it indicates that there is an error in the operation of PLC. (Firmware version V3.4.5 and above supports this function by PLC)	
SM005	Battery low alarm coil	When the battery voltage is less than 2.5V, SM5 will put ON (at this time, please replace the battery as soon as possible, otherwise the data will not be maintained)	
SM007	Power-off memory data error		

### Clock (SM11-SM14)

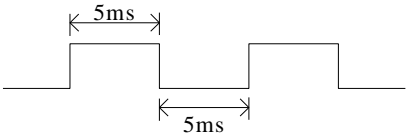
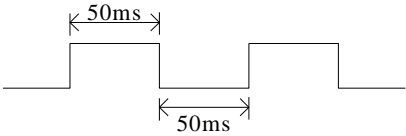
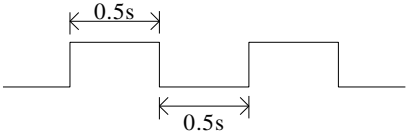
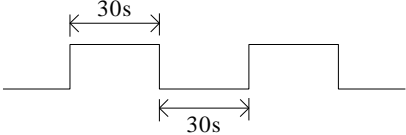
ID	Function	Description
SM011	10ms frequency cycle	
SM012	100ms frequency cycle	
SM013	1s frequency cycle	
SM014	1min frequency cycle	

### Mark (SM20-SM22)

ID	Function	Description
SM020	Zero bit	SM020 is ON when plus/minus operation result is 0
SM021	Borrow bit	SM021 is ON when minus operation overflows
SM022	Carry bit	SM022 is ON when plus operation overflows

### PC Mode (SM32-SM34)

ID	Function	Description
SM032	Retentive register reset	When SM032 is ON, ON/OFF mapping memory of HM, HS and current values of HT, HC, HD will be reset.
SM033	Clear user's program	When SM033 is ON, all PLC user's program will be cleared.
SM034	All output forbidden	When SM034 is ON, all PLC external contacts will be set

	OFF.
--	------

### Stepping Ladder

ID	Function	Description
SM040	The process is running	Set ON when the process is running

### Interruption ban (SM50-SM90)

ID	Address	Function	Description
SM050	I0000/I0001	Forbid input interruption 0	After executing EI instruction, the input interruption couldn't act independently when M acts, even if the interruption is allowed. E.g.: when SM050 is ON, I0000/I0001 is forbidden.
SM051	I0100/I0101	Forbid input interruption 1	
SM052	I0200/I0201	Forbid input interruption 2	
SM053	I0300/I0301	Forbid input interruption 3	
SM054	I0400/I0401	Forbid input interruption 4	
.....	.....	.....	
SM069	I1900/I1901	Forbid input interruption 19	After executing EI instruction, the timing interruption couldn't act independently when M acts, even if the interruption is allowed.
SM070	I40**	Forbid timing interruption 0	
SM071	I41**	Forbid timing interruption 1	
SM072	I42**	Forbid timing interruption 2	
SM073	I43**	Forbid timing interruption 3	
SM074	I44**	Forbid timing interruption 4	
.....	.....	.....	
SM089	I59**	Forbid timing interruption 19	
SM090		Forbid all interruptions	Forbid all interruptions

### High Speed Ring Counter (SM99)

address	Function	Note
SM099	High Speed Ring Counting enable	SM99 set ON, SD99 add one per 0.1ms, cycle between 0 and 32767

### High speed count complete (SM100-SM109)

Address	Function	Note
SM100	HSC0 count complete flag (100 segments)	
SM101	HSC2 count complete flag (100 segments)	
SM102	HSC4 count complete flag (100 segments)	
SM103	HSC6 count complete flag (100 segments)	
SM104	HSC8 count complete flag (100 segments)	
SM105	HSC10 count complete flag (100 segments)	
SM106	HSC12 count complete flag (100 segments)	
SM107	HSC14 count complete flag (100 segments)	
SM108	HSC16 count complete flag (100 segments)	
SM109	HSC18 count complete flag (100 segments)	

### High speed counter direction (SM110-SM119)

Address	Function	Note
SM110	HSC0 direction flag	
SM111	HSC2 direction flag	
SM112	HSC4 direction flag	
SM113	HSC6 direction flag	
SM114	HSC8 direction flag	
SM115	HSC10 direction flag	
SM116	HSC12 direction flag	
SM117	HSC14 direction flag	
SM118	HSC16 direction flag	
SM119	HSC18 direction flag	

### High speed counter error (SM120-SM129)

address	Function	Note
SM120	HSC0 error flag	
SM121	HSC2 error flag	
SM122	HSC4 error flag	
SM123	HSC6 error flag	
SM124	HSC8 error flag	
SM125	HSC10 error flag	
SM126	HSC12 error flag	
SM127	HSC14 error flag	
SM128	HSC16 error flag	
SM129	HSC18 error flag	

**Communication (SM140-SM193)**

	Address	Function	Note
Serial port 0	SM140	Modbus instruction execution flag	When the instruction starts to execute, set ON When execution is complete, set OFF
	SM141	X-NET instruction execution flag	When the instruction starts to execute, set ON When execution is complete, set OFF
	SM142	Free format communication sending flag	When the instruction starts to execute, set ON When execution is complete, set OFF
	SM143	Free format communication receive complete flag	When receiving a frame of data or receiving data timeout, set ON. Require user program to set OFF
Serial port 1	SM150	Modbus instruction execution flag	Same to SM140
	SM151	X-NET instruction execution flag	Same to SM141
	SM152	Free format communication sending flag	Same to SM142
	SM153	Free format communication receive complete flag	Same to SM143
Serial port 2	SM160	Modbus instruction execution flag	Same to SM140
	SM161	X-NET instruction execution flag	Same to SM141
	SM162	Free format communication sending flag	Same to SM142
	SM163	Free format communication receive complete flag	Same to SM143
Serial port 3	SM170	Modbus instruction execution flag	Same to SM140
	SM171	X-NET instruction execution flag	Same to SM141
	SM172	Free format communication sending flag	Same to SM142
	SM173	Free format communication receive complete flag	Same to SM143
Serial port 4	SM180	Modbus instruction execution flag	Same to SM140
	SM181	X-NET instruction execution flag	Same to SM141
	SM182	Free format communication sending flag	Same to SM142
	SM183	Free format communication receive complete flag	Same to SM143
Serial	SM190	Modbus instruction execution flag	Same to SM140

port 5	SM191	X-NET instruction execution flag	Same to SM141
	SM192	Free format communication sending flag	Same to SM142
	SM193	Free format communication receive complete flag	Same to SM143

### Sequence Function BLOCK (SM240-SM349)

ID	Function	Description
SM300	BLOCK1 running flag	SM300 will be ON when block1 is running
SM301	BLOCK2 running flag	SM301 will be ON when block2 is running
SM302	BLOCK3 running flag	SM302 will be ON when block3 is running
SM303	BLOCK4 running flag	SM303 will be ON when block4 is running
SM304	BLOCK5 running flag	SM304 will be ON when block5 is running
SM305	BLOCK6 running flag	SM305 will be ON when block6 is running
.....	.....	
SM346	BLOCK47 running flag	SM346 will be ON when block47 is running
SM347	BLOCK48 running flag	SM347 will be ON when block48 is running
SM348	BLOCK49 running flag	SM348 will be ON when block49 is running
SM349	BLOCK50 running flag	SM349 will be ON when block50 is running

### Error check (SM400-SM413)

ID	Function	Description
SM400	I/O error	ERR LED keeps ON, PLC don not run and output, check when power on
SM401	Expansion module communication error	
SM402	BD communication error	
.....		
SM405	No user program	Internal code check wrong
SM406	User program error	Implement code or configuration table check wrong
SM407	SSFD check error	ERR LED keeps ON, PLC don not run and output, check when power on
SM408	Memory error	Can not erase or write Flash
SM409	Calculation error	
SM410	Offset overflow	Offset exceeds soft element range
SM411	FOR-NEXT	Reset when power on or users can also reset by hand.

	overflow	
SM412	Invalid data fill	When offset of register overflows, the return value will be SM372 value

### Error Message (SM450-SM452)

ID	Function	Description
SM450	System error check	
SM451	Hardfault interrupt flag	
SM452		
SM453	SD card error	
SM454	Power supply is cut off	
.....		
SM460	Extension module ID not match	
SM461	BD/ED module ID not match	
SM462	Extension module communication overtime	
SM463	BD/ED module communication overtime	

### Expansion Modules, BD Status (SM500)

ID	Function	Description
SM500	Module status read is finished	

### High speed pulse (SM1000-SM1190)

ID	Function	Explanation	Output point
SM1000	Pulse sending flag	ON: Pulse is sending	Y0
SM1001	Direction flag	1 is positive direction, related direction signal is ON	
SM1002	Accumulated pulse number overflow flag	1 is overflow	
SM1003	Accumulated pulse equivalent overflow flag	1 is overflow	
SM1004			
SM1005			
SM1006			
SM1007			
SM1008			
SM1009			



SM1010	Pulse error flag	ON: error	
SM1020	Pulse sending flag	ON: Pulse is sending	Y1
SM1021	Direction flag	1 is positive direction, related direction signal is ON	
SM1022	Accumulated pulse number overflow flag	1 is overflow	
SM1023	Accumulated pulse equivalent overflow flag	1 is overflow	
SM1024			
SM1025			
SM1026			
SM1027			
SM1028			
SM1029			
SM1030	Pulse error flag	ON: error	
SM1040	Pulse sending flag	ON: Pulse is sending	Y2
SM1041	Direction flag	1 is positive direction, related direction signal is ON	
SM1042	Accumulated pulse number overflow flag	1 is overflow	
SM1043	Accumulated pulse equivalent overflow flag	1 is overflow	
SM1044			
SM1045			
SM1046			
SM1047			
SM1048			
SM1049			
SM1050	Pulse error flag	ON: error	
SM1060	Pulse sending flag	ON: Pulse is sending	Y3
SM1061	Direction flag	1 is positive direction, related direction signal is ON	
SM1062	Accumulated pulse number overflow flag	1 is overflow	
SM1063	Accumulated pulse equivalent overflow flag	1 is overflow	
SM1064			
SM1065			
SM1066			
SM1067			
SM1068			
SM1069			
SM1070	Pulse error flag	ON: error	

SM1080	Pulse sending flag	ON: Pulse is sending	Y4
SM1081	Direction flag	1 is positive direction, related direction signal is ON	
SM1082	Accumulated pulse number overflow flag	1 is overflow	
SM1083	Accumulated pulse equivalent overflow flag	1 is overflow	
SM1084			
SM1085			
SM1086			
SM1087			
SM1088			
SM1089			
SM1090	Pulse error flag	ON: error	Y5
SM1100	Pulse sending flag	ON: Pulse is sending	
SM1101	Direction flag	1 is positive direction, related direction signal is ON	
SM1102	Accumulated pulse number overflow flag	1 is overflow	
SM1103	Accumulated pulse equivalent overflow flag	1 is overflow	
SM1104			
SM1105			
SM1106			
SM1107			
SM1108			
SM1109			Y6
M1110	Pulse error flag	ON: error	
SM1120	Pulse sending flag	ON: Pulse is sending	
SM1121	Direction flag	1 is positive direction, related direction signal is ON	
SM1122	Accumulated pulse number overflow flag	1 is overflow	
SM1123	Accumulated pulse equivalent overflow flag	1 is overflow	
SM1124			
SM1125			
SM1126			
SM1127			
SM1128			Y7
SM1129			
SM1130	Pulse error flag	ON: error	Y7
SM1140	Pulse sending flag	ON: Pulse is sending	

SM1141	Direction flag	1 is positive direction, related direction signal is ON	
SM1142	Accumulated pulse number overflow flag	1 is overflow	
SM1143	Accumulated pulse equivalent overflow flag	1 is overflow	
SM1144			
SM1145			
SM1146			
SM1147			
SM1148			
SM1149			
SM1150	Pulse error flag	ON: error	
SM1160	Pulse sending flag	ON: Pulse is sending	Y10
SM1161	Direction flag	1 is positive direction, related direction signal is ON	
SM1162	Accumulated pulse number overflow flag	1 is overflow	
SM1163	Accumulated pulse equivalent overflow flag	1 is overflow	
SM1164			
SM1165			
SM1166			
SM1167			
SM1168			
SM1169			
SM1170	Pulse error flag	ON: error	
SM1180	Pulse sending flag	ON: Pulse is sending	Y11
SM1181	Direction flag	1 is positive direction, related direction signal is ON	
SM1182	Accumulated pulse number overflow flag	1 is overflow	
SM1183	Accumulated pulse equivalent overflow flag	1 is overflow	
SM1184			
SM1185			
SM1186			
SM1187			
SM1188			
SM1189			
SM1190	Pulse error flag	ON: error	

## Appendix 2. Special data register list

### Battery (SD5~SD7)

ID	Function	Description
SD005	Battery register	It will display 100 when the battery voltage is 3V, if the battery voltage is lower than 2.5V, it will display 0, it means please change new battery at once, otherwise the data will lose when PLC power off.
SD007	Power-off memory data error type	

### Clock (SD10-SD19)

ID	Function	Description
SD010	Current scan cycle	100us, us is the unit
SD011	Min scan time	100us, us is the unit
SD012	Max scan time	100us, us is the unit
SD013	Second (clock)	0~59 (BCD code)
SD014	Minute (clock)	0~59 (BCD code)
SD015	Hour (clock)	0~23 (BCD code)
SD016	Day (clock)	0~31 (BCD code)
SD017	Month (clock)	0~12 (BCD code)
SD018	Year (clock)	2000~2099 (BCD code)
SD019	Week (clock)	0(Sunday)~6(Saturday)(BCD code)

### Flag (SD020-SD031)

ID	Function	Note
SD020	Model type	
SD021	model (low-8) series (high-8)	
SD022	Compatible system version (low) system version (high)	
SD023	Compatible model version (low) model version (high)	
SD024	Model info	
SD025	Model info	
SD026	Model info	
SD027	Model info	
SD028	Suitable software version	
SD029	Suitable software version	
SD030	Suitable software version	
SD031	Suitable software version	

### Step ladder (SD040)

ID	Function	Description
SD40	Flag of the executing process S	

### High Speed Counting (SD100-SD109)

ID	Function	Description	
SD100	Current segment (No. n segment)		HSC00
SD101	Current segment (No. n segment)		HSC02
SD102	Current segment (No. n segment)		HSC04
SD103	Current segment (No. n segment)		HSC06
SD104	Current segment (No. n segment)		HSC08
SD105	Current segment (No. n segment)		HSC10
SD106	Current segment (No. n segment)		HSC12
SD107	Current segment (No. n segment)		HSC14
SD108	Current segment (No. n segment)		HSC16
SD109	Current segment (No. n segment)		HSC18

### High speed counter error (SD120-SD129)

ID	Function	Note
SD120	HSC0 error info	
SD121	HSC2 error info	
SD122	HSC4 error info	
SD123	HSC6 error info	
SD124	HSC8 error info	
SD125	HSC10 error info	
SD126	HSC12 error info	
SD127	HSC14 error info	
SD128	HSC16 error info	
SD129	HSC18 error info	

### communication (SD140~SD199)

	ID	Function	Note
	SD140	Modbus read write instruction execution result	0: correct 100: receive error 101: receive overtime

Serial port 0			180: CRC error 181: LRC error 182: station error 183: send buffer overflow 400: function code error 401: address error 402: length error 403: data error 404: slave station busy 405: memory error (erase FLASH)
	SD141	X-Net communication result	0: correct 1: communication overtime 2: memory error 3: receive CRC error
	SD142	Free format communication send result	0: correct 410: free format send buffer overflow
	SD143	Free format communication receive result	0: correct 410: send data length overflow 411: receive data short 412: receive data long 413: receive error 414: receive overtime 415: no start character 416: no end character
	SD144	Free format communication receive data numbers	In bytes, there are no start and stop characters
	.....		
	SD149		
Serial port 1	SD150	Modbus read write instruction execution result	0: correct 100: receive error 101: receive overtime 180: CRC error 181: LRC error 182: station error 183: send buffer overflow 400: function code error 401: address error 402: length error 403: data error 404: slave station busy 405: memory error (erase FLASH)
	SD151	X-Net communication result	0: correct 1: communication overtime 2: memory error

			3: receive CRC error
	SD152	Free format communication send result	0: correct 410: free format send buffer overflow
	SD153	Free format communication receive result	0: correct 410: send data length overflow 411: receive data short 412: receive data long 413: receive error 414: receive overtime 415: no start character 416: no end character
	SD154	Free format communication receive data numbers	In bytes, there are no start and stop characters
	.....		
	SD159		
Serial port 2	SD160	Modbus read write instruction execution result	0: correct 100: receive error 101: receive overtime 180: CRC error 181: LRC error 182: station error 183: send buffer overflow 400: function code error 401: address error 402: length error 403: data error 404: slave station busy 405: memory error (erase FLASH)
	SD161	X-Net communication result	0: correct 1: communication overtime 2: memory error 3: receive CRC error
	SD162	Free format communication send result	0: correct 410: free format send buffer overflow
	SD163	Free format communication receive result	0: correct 410: send data length overflow 411: receive data short 412: receive data long 413: receive error 414: receive overtime 415: no start character 416: no end character
	SD164	Free format communication receive data numbers	In bytes, there are no start and stop characters

	.....		
	SD169		
Serial port 3	SD170~SD179		
Serial port 4	SD180~SD189		
Serial port 5	SD190~SD199		

### Sequence Function Block (SD300-SD399)

ID	Function	Description
SD300	Executing instruction of BLOCK1	The value will be used when BLOCK monitors
SD301	Executing instruction of BLOCK2	The value will be used when BLOCK monitors
SD302	Executing instruction of BLOCK3	The value will be used when BLOCK monitors
SD303	Executing instruction of BLOCK4	The value will be used when BLOCK monitors
SD304	Executing instruction of BLOCK5	The value will be used when BLOCK monitors
SD305	Executing instruction of BLOCK6	The value will be used when BLOCK monitors
.....	.....	.....
SD396	Executing instruction of BLOCK97	The value will be used when BLOCK monitors
SD397	Executing instruction of BLOCK98	The value will be used when BLOCK monitors
SD398	Executing instruction of BLOCK99	The value will be used when BLOCK monitors
SD399	Executing instruction of BLOCK100	The value will be used when BLOCK monitors

### Error Check (SD400-SD413)

ID	Function	Note
SD400		
SD401	Extension module no. of communication error	Means module no.n is error
SD402	BD/ED module no. of communication error	
SD403	FROM/TO error type	
SD404	PID error type	
.....		
SD409	Calculation error code	1: divide by 0 error 2: MRST, MSET front operand address less than back operand



		3: ENCO, DECO data bits of encoding and decoding instructions exceed the limit. 4: BDC code error 7: Radical sign error
SD410	The number of offset register D when offset crosses the boundary	
SD411		
SD412	Invalid data fill value (low 16 bits)	
SD413	Invalid data fill value (high 16 bits)	

### Error Check (SD450-SD452)

ID	Function	Description
SD450	1: Watchdog act (Default 200ms) 2: Control block application fail 3: Visit illegal address	
SD451	Hardware error type: 1: Register error 2: Bus error 3: Usage error	
SD452	Hardware error	
SD453	SD card error	
SD454	Power-off time	
SD460	Extension module ID not match	
SD461	BD/ED module ID not match	
SD462	Extension module communication overtime	
SD463	BD/ED module communication overtime	

### Expansion Modules, BD Status (SD500-SD516)

ID	Function	Description	
SD500	Module number Expansion modules: #10000~10015 BD: #20000~20001 ED: #30000		
SD501~516	Expansion module, BD /ED status		16 registers

### Module info (SD520-SD823)

ID	Function	Explanation	Note
SD520~SD535	Extension module info	Extension module 1	Each extension module, BD, ED occupies 16 registers
.....	.....	.....	
SD760~SD775	Extension module info	Extension module 16	
SD776~SD791	BD module info	BD module 1	
SD792~SD807	BD module info	BD module 2	
SD808~SD823	ED module info	ED module 1	

### Expansion Module Error Information

ID	Function	Description	
SD860	Error times of module read		Expansion module 1
SD861	Error types of module read	Module address error. Module accepted data length error. Module CRC parity error when PLC is accepting data. Module ID error. Module overtime error.	
SD862	Error times of module write		
SD863	Error types of module write		
SD864	Error times of module read		Expansion module 2
SD865	Error types of module read	Module address error. Module accepted data length error. Module CRC parity error when PLC is accepting data. Module ID error. Module overtime error.	
SD866	Error times of module write		
SD867	Error types of module write		
.....			
SD920	Error times of module read		Expansion module 16
SD921	Error types of module read	Module address error. Module accepted data length error. Module CRC parity error when PLC is accepting data. Module ID error. Module overtime error.	
SD922	Error times of module write		

SD923	Error types of module write		
SD924	Error times of module read		BD module 1
SD925	Error types of module read		
SD926	Error times of module write		
SD927	Error types of module write		
SD928	Error times of module read		BD module 2
SD929	Error types of module read		
SD930	Error times of module write		
SD931	Error types of module write		
SD932	Error times of module read		ED module 1
SD933	Error types of module read		
SD934	Error times of module write		
SD935	Error types of module write		

#### Version info (SD990~SD993)

ID	Function	Explanation	Note
SD990	Firmware version date	Low 16-bit	
SD991	Firmware version compilation date	High 16-bit	
SD992	FPGA version compilation date	Low 16-bit	
SD993	FPGA version compilation date	High 16-bit	

#### High speed pulse (SD1000-SD1099)

ID	Function	Explanation	Output point
SD1000	Present segment (segment n)		Y0
SD1001			
SD1002	Present pulse number low 16-bit	(the unit is pulse number)	
SD1003	Present pulse number high 16-bit	(the unit is pulse number)	
SD1004	Present pulse number low 16-bit	(the unit is pulse equivalent)	
SD1005	Present pulse number high	(the unit is pulse equivalent)	

	16-bit		
SD1006	Present output frequency low 16-bit	(the unit is pulse number)	
SD1007	Present output frequency high 16-bit	(the unit is pulse number)	
SD1008	Present output frequency low 16-bit	(the unit is pulse equivalent)	
SD1009	Present output frequency high 16-bit	(the unit is pulse equivalent)	
SD1010	Pulse error information	<p>1: pulse data segment configuration error</p> <p>2: In equivalent mode, the number of pulses per turn and the movement per 1 turn is 0.</p> <p>3: System parameter block number error</p> <p>4: Pulse parameter block number exceeding maximum limit</p> <p>5: Stop after encountering positive limit signal</p> <p>6: Stop after meeting the negative limit signal</p> <p>10: No origin signal is set for origin regression</p> <p>11: Velocity of origin regression VH is 0</p> <p>12: Origin regression crawling speed VC is 0 or <math>VC \geq VH</math></p> <p>13: Origin regression signal error</p> <p>15: Follow Performance Parameters <math>\leq 0</math> or <math>&gt;100</math></p> <p>16: Follow Feedforward Compensation <math>&lt; 0</math> or <math>&gt;100</math></p> <p>17: Follow Multiplication Coefficient and Division Coefficient Ratio <math>\leq 0</math> or <math>&gt;100</math></p> <p>20: Interpolation Direction Terminal Not Set or Set Error</p> <p>21: The default maximum interpolation speed is 0</p> <p>22: Arc interpolation data error</p> <p>23: Arc radius data error</p> <p>24: Three-point Arc Data Error</p> <p>25: In polar coordinate mode, the current position is (0, 0)</p> <p>26: Control block allocation failed</p>	
SD1011	error pulse data block number		
SD1020	Present segment (segment n)		
SD1021			Y1
SD1022	Present pulse number low 16-bit	(the unit is pulse number)	

SD1023	Present pulse number high 16-bit	(the unit is pulse number)	
SD1024	Present pulse number low 16-bit	(the unit is pulse equivalent)	
SD1025	Present pulse number high 16-bit	(the unit is pulse equivalent)	
SD1026	Present output frequency low 16-bit	(the unit is pulse number)	
SD1027	Present output frequency high 16-bit	(the unit is pulse number)	
SD1028	Present output frequency low 16-bit	(the unit is pulse equivalent)	
SD1029	Present output frequency high 16-bit	(the unit is pulse equivalent)	
SD1030	Pulse error information	Same to SD1010	
SD1031	error pulse data block number		
SD1040	Present segment (segment n)		Y2
SD1041			
SD1042	Present pulse number low 16-bit	(the unit is pulse number)	
SD1043	Present pulse number high 16-bit	(the unit is pulse number)	
SD1044	Present pulse number low 16-bit	(the unit is pulse equivalent)	
SD1045	Present pulse number high 16-bit	(the unit is pulse equivalent)	
SD1046	Present output frequency low 16-bit	(the unit is pulse number)	
SD1047	Present output frequency high 16-bit	(the unit is pulse number)	
SD1048	Present output frequency low 16-bit	(the unit is pulse equivalent)	
SD1049	Present output frequency high 16-bit	(the unit is pulse equivalent)	
SD1050	Pulse error information	Same to SD1010	
SD1051	error pulse data block number		
SD1060	Present segment		Y3

	(segment n)		
SD1061			
SD1062	Present pulse number low 16-bit	(the unit is pulse number)	
SD1063	Present pulse number high 16-bit	(the unit is pulse number)	
SD1064	Present pulse number low 16-bit	(the unit is pulse equivalent)	
SD1065	Present pulse number high 16-bit	(the unit is pulse equivalent)	
SD1066	Present output frequency low 16-bit	(the unit is pulse number)	
SD1067	Present output frequency high 16-bit	(the unit is pulse number)	
SD1068	Present output frequency low 16-bit	(the unit is pulse equivalent)	
SD1069	Present output frequency high 16-bit	(the unit is pulse equivalent)	
SD1070	Pulse error information	Same to SD1010	
SD1071	error pulse data block number		
SD1080	Present segment (segment n)		
SD1082	Present pulse number low 16-bit	(the unit is pulse number)	
SD1083	Present pulse number high 16-bit	(the unit is pulse number)	
SD1084	Present pulse number low 16-bit	(the unit is pulse equivalent)	
SD1085	Present pulse number high 16-bit	(the unit is pulse equivalent)	Y4
SD1086	Present output frequency low 16-bit	(the unit is pulse number)	
SD1087	Present output frequency high 16-bit	(the unit is pulse number)	
SD1088	Present output frequency low 16-bit	(the unit is pulse equivalent)	
SD1089	Present output frequency high 16-bit	(the unit is pulse equivalent)	
SD1090	Pulse error information	Same to SD1010	

SD1091	error pulse data block number		
SD1100	Present segment (segment n)		Y5
SD1102	Present pulse number low 16-bit	(the unit is pulse number)	
SD1103	Present pulse number high 16-bit	(the unit is pulse number)	
SD1104	Present pulse number low 16-bit	(the unit is pulse equivalent)	
SD1105	Present pulse number high 16-bit	(the unit is pulse equivalent)	
SD1106	Present output frequency low 16-bit	(the unit is pulse number)	
SD1107	Present output frequency high 16-bit	(the unit is pulse number)	
SD1108	Present output frequency low 16-bit	(the unit is pulse equivalent)	
SD1109	Present output frequency high 16-bit	(the unit is pulse equivalent)	
SD1110	Pulse error information	Same to SD1010	
SD1111	error pulse data block number		
SD1120	Present segment (segment n)		Y6
SD1122	Present pulse number low 16-bit	(the unit is pulse number)	
SD1123	Present pulse number high 16-bit	(the unit is pulse number)	
SD1124	Present pulse number low 16-bit	(the unit is pulse equivalent)	
SD1125	Present pulse number high 16-bit	(the unit is pulse equivalent)	
SD1126	Present output frequency low 16-bit	(the unit is pulse number)	
SD1127	Present output frequency high 16-bit	(the unit is pulse number)	
SD1128	Present output frequency	(the unit is pulse equivalent)	

	low 16-bit		
SD1129	Present output frequency high 16-bit	(the unit is pulse equivalent)	
SD1130	Pulse error information	Same to SD1010	
SD1131	error pulse data block number		
SD1140	Present segment (segment n)		
SD1142	Present pulse number low 16-bit	(the unit is pulse number)	
SD1143	Present pulse number high 16-bit	(the unit is pulse number)	
SD1144	Present pulse number low 16-bit	(the unit is pulse equivalent)	
SD1145	Present pulse number high 16-bit	(the unit is pulse equivalent)	
SD1146	Present output frequency low 16-bit	(the unit is pulse number)	Y7
SD1147	Present output frequency high 16-bit	(the unit is pulse number)	
SD1148	Present output frequency low 16-bit	(the unit is pulse equivalent)	
SD1149	Present output frequency high 16-bit	(the unit is pulse equivalent)	
SD1150	Pulse error information	Same to SD1010	
SD1151	error pulse data block number		
SD1160	Present segment (segment n)		
SD1162	Present pulse number low 16-bit	(the unit is pulse number)	
SD1163	Present pulse number high 16-bit	(the unit is pulse number)	Y10
SD1164	Present pulse number low 16-bit	(the unit is pulse equivalent)	
SD1165	Present pulse number high 16-bit	(the unit is pulse equivalent)	
SD1166	Present output frequency	(the unit is pulse number)	



	low 16-bit		
SD1167	Present output frequency high 16-bit	(the unit is pulse number)	
SD1168	Present output frequency low 16-bit	(the unit is pulse equivalent)	
SD1169	Present output frequency high 16-bit	(the unit is pulse equivalent)	
SD1170	Pulse error information	Same to SD1010	
SD1171	error pulse data block number		
SD1180	Present segment (segment n)		
SD1182	Present pulse number low 16-bit	(the unit is pulse number)	
SD1183	Present pulse number high 16-bit	(the unit is pulse number)	
SD1184	Present pulse number low 16-bit	(the unit is pulse equivalent)	
SD1185	Present pulse number high 16-bit	(the unit is pulse equivalent)	
SD1186	Present output frequency low 16-bit	(the unit is pulse number)	Y11
SD1187	Present output frequency high 16-bit	(the unit is pulse number)	
SD1188	Present output frequency low 16-bit	(the unit is pulse equivalent)	
SD1189	Present output frequency high 16-bit	(the unit is pulse equivalent)	
SD1190	Pulse error information	Same to SD1010	
SD1191	error pulse data block number		

**Special data register HSD (power-off retentive)**

High speed pulse

ID	Function	Explanation	Output point
HSD0	Accumulated pulse number low 16-bit (the unit is pulse number)		Y0
HSD1	Accumulated pulse number high 16-bit (the unit is pulse number)		
HSD2	Accumulated pulse number low 16-bit (the unit is pulse equivalent)		
HSD3	Accumulated pulse number high 16-bit (the unit is pulse equivalent)		
HSD4	Accumulated pulse number low 16-bit (the unit is pulse number)		Y1
HSD5	Accumulated pulse number high 16-bit (the unit is pulse number)		
HSD6	Accumulated pulse number low 16-bit (the unit is pulse equivalent)		
HSD7	Accumulated pulse number high 16-bit (the unit is pulse equivalent)		
HSD8	Accumulated pulse number low 16-bit (the unit is pulse number)		Y2
HSD9	Accumulated pulse number high 16-bit (the unit is pulse number)		
HSD10	Accumulated pulse number low 16-bit (the unit is pulse equivalent)		
HSD11	Accumulated pulse number high 16-bit (the unit is pulse equivalent)		
HSD12	Accumulated pulse number low 16-bit (the unit is pulse number)		Y3
HSD13	Accumulated pulse number high 16-bit (the unit is pulse number)		
HSD14	Accumulated pulse number low 16-bit (the unit is pulse equivalent)		
HSD15	Accumulated pulse number high 16-bit (the unit is pulse equivalent)		
HSD16	Accumulated pulse number low 16-bit (the unit is pulse number)		Y4
HSD17	Accumulated pulse number high 16-bit (the unit is pulse number)		
HSD18	Accumulated pulse number low 16-bit (the unit is pulse equivalent)		

HSD19	Accumulated pulse number high 16-bit (the unit is pulse equivalent)		
HSD20	Accumulated pulse number low 16-bit (the unit is pulse number)		Y5
HSD21	Accumulated pulse number high 16-bit (the unit is pulse number)		
HSD22	Accumulated pulse number low 16-bit (the unit is pulse equivalent)		
HSD23	Accumulated pulse number high 16-bit (the unit is pulse equivalent)		
HSD24	Accumulated pulse number low 16-bit (the unit is pulse number)		
HSD25	Accumulated pulse number high 16-bit (the unit is pulse number)		Y6
HSD26	Accumulated pulse number low 16-bit (the unit is pulse equivalent)		
HSD27	Accumulated pulse number high 16-bit (the unit is pulse equivalent)		
HSD28	Accumulated pulse number low 16-bit (the unit is pulse number)		
HSD29	Accumulated pulse number high 16-bit (the unit is pulse number)		Y7
HSD30	Accumulated pulse number low 16-bit (the unit is pulse equivalent)		
HSD31	Accumulated pulse number high 16-bit (the unit is pulse equivalent)		
HSD32	Accumulated pulse number low 16-bit (the unit is pulse number)		Y10
HSD33	Accumulated pulse number high 16-bit (the unit is pulse number)		
HSD34	Accumulated pulse number low 16-bit (the unit is pulse equivalent)		
HSD35	Accumulated pulse number high 16-bit (the unit is pulse equivalent)		
HSD36	Accumulated pulse number low 16-bit (the unit is pulse number)		
HSD37	Accumulated pulse number high 16-bit (the unit is pulse number)		Y11
HSD38	Accumulated pulse number low 16-bit (the unit is pulse equivalent)		
HSD39	Accumulated pulse number high 16-bit (the unit is pulse equivalent)		

### Appendix 3. Special FLASH register list

#### Special FLASH data register SFD

\* means it works only after repower on the PLC

#### I filtering

ID	Function	Description
SFD0*	Input filter time	
SFD2*	Watchdog run-up time, default value is 200ms	

#### I Mapping

ID	Function	Description	
SFD10*	I00 corresponds to X**	Input terminal 0 corresponds to X** number	0xFF means terminal bad, 0xFE means terminal idle
SFD11*	I01 corresponds to X**		
SFD12*	I02 corresponds to X**		
.....	.....		
SFD73*	I77 corresponds to X**	Default value is 77 (Octonary)	

#### O Mapping

ID	Function	Description	
SFD74*	O00 corresponds to Y**	Output terminal 0 correspond to Y** number	0xFF means terminal bad, 0xFE means terminal idle
		Default value is 0	
.....	.....		
SFD134*	O77 corresponds to Y**	Default value is 77 (Octonary)	

#### I Attribute

ID	Function	Description	
SFD138*	I00 attribute	Attribute of input terminal 0	0: positive logic others: negative logic
SFD139*	I01 attribute		
.....	.....		
SFD201*	I77 attribute		

**High Speed Counting**

ID	Function	Description
SFD320	HSC0 frequency times	2: 2 times frequency; 4: 4 times frequency(effective at AB phase counting mode)
SFD321	HSC2 frequency times	Ditto
SFD322	HSC4 frequency times	Ditto
SFD323	HSC6 frequency times	Ditto
SFD324	HSC8 frequency times	Ditto
SFD325	HSC10 frequency times	Ditto
SFD326	HSC12 frequency times	Ditto
SFD327	HSC14 frequency times	Ditto
SFD328	HSC16 frequency times	Ditto
SFD329	HSC18 frequency times	Ditto
SFD330	Bit selection of HSC absolute and relative (24 segment)	bit0 corresponds to HSC0, bit1 corresponds to HSC2, and so on, bit9 corresponds to HSC18 0: relative 1: absolute
SFD331	Interrupt circulating of 24 segments high speed counting	bit0 corresponds to HSC0, bit1 corresponds to HSC2, and so on, bit9 corresponds to HSC18 0: single 1: loop
SFD332	CAM function	bit0 corresponds to HSC0, bit1 corresponds to HSC2, and so on, bit9 corresponds to HSC18 0: do not support CAM function 1: support CAM function

**Expansion Module Configuration**

ID	Function	Explanation
SFD340	Extension module configuration status (#1#2)	Configuration Status of Extension Modules 1 and 2
SFD341	Extension module configuration status (#3#4)	Configuration Status of Extension Modules 3 and 4
.....	.....	.....
SFD347	Extension module configuration status (#15#16)	Configuration Status of Extension Modules 15 and 16
SFD348	BD module configuration status (#1#2)	Configuration Status of BD Modules 1 and 2
SFD349	ED module configuration status (#1)	Configuration Status of ED Module 1
SFD350	Extension module configuration	Configuration of Extension Module 1
SFD359	:	
SFD360	Extension module configuration	Configuration of Extension Module 2
:	:	

SFD369		
:	:	
SFD500	Extension module configuration	Configuration of Extension Module 16
:		
SFD509		
SFD510	BD module configuration	Configuration of BD Module 1
:		
SFD519		
SFD520	BD module configuration	Configuration of BD Module 2
:		
SFD529		
SFD530	ED module configuration	Configuration of ED Module 1
:		
SFD539		

### Communication

ID	Function	Note
SFD600	COM1 free format communication buffer bit numbers	0: 8-bit 1: 16-bit
SFD610	COM2 free format communication buffer bit numbers	0: 8-bit 1: 16-bit
SFD620	COM3 free format communication buffer bit numbers	0: 8-bit 1: 16-bit
SFD630	COM4 free format communication buffer bit numbers	0: 8-bit 1: 16-bit
SFD640	COM5 free format communication buffer bit numbers	0: 8-bit 1: 16-bit

**Motion control**

ID	function	Explanation
<b>Y0 (common parameters)</b>		
SFD900	Pulse parameters	Bit1: pulse direction logic 0: positive logic, 1: negative logic, default is 0 Bit2: soft position limit 0: OFF 1: ON, default is 0 Bit3: machine back to origin direction 0: negative direction 1: positive direction, default is 0 Bit4: motor operation mode (closed loop pulse) 0: position mode 1: pulse mode, default is 0 Bit10~ Bit8: pulse unit Bit8: 0: pulse numbers, 1: equivalent 000: pulse numbers 001: micron 011: centimeter 101: decimeter 111: millimeter Default is 000 Bit13: pulse type 0: single direction pulse 1: AB phase pulse (only for XD5-48D4T4-E), default is 0 Bit15: interpolation coordinate mode 0: cross coordinate, 1: polar coordinate, default is 0
SFD901	Pulse sending mode	Bit 0: pulse sending mode 0: complete mode; 1: continue mode Default is 0
SFD902	Pulse number/1 rotation low 16-bit	
SFD903	Pulse number/1 rotation high 16-bit	
SFD904	Moving amount/1 rotation low 16-bit	
SFD905	Moving amount/1 rotation high 16-bit	
SFD906	Pulse direction terminal	Appoint to Y terminal, 0xFF is no terminal
SFD907	Direction delay time	Default is 20, unit: ms
SFD908	Gear clearance positive compensation	
SFD909	Gear clearance negative compensation	
SFD910	Electrical origin position low 16-bit	
SFD911	Electrical origin position high 16-bit	

SFD912	Signal terminal switch state	Bit0: Origin Signal Switch State Settings Bit1: Z Phase Switch State Settings Bit2: Positive Limit Switching State Settings Bit3: Negative Limit Switching State Settings 0: Normally open (positive logic), 1: Normally closed (negative logic); default is 0
SFD913	Near-point signal terminal setting	
SFD914	Z phase terminal setting	Bit0~Bit7: Specify the number of the X terminal, 0xFF is no terminal
SFD915	Limit terminal setting	Bit7~Bit0: Specifies the X terminal number of the positive limit, and 0xFF is no terminal. Bit15~Bit8: Specifies the X terminal number of the negative limit, and 0xFF is no terminal.
SFD917	Zero clear CLR output signal	Bit0~Bit7: Specify the number of the Y terminal, 0xFF is no terminal
SFD918	Return speed VH low 16-bit	
SFD919	Return speed VH high 16-bit	
SFD922	Creeping speed VC low 16-bit	
SFD923	Creeping speed VC high 16-bit	
SFD924	Mechanical origin position low 16-bit	
SFD925	Mechanical origin position high 16-bit	
SFD926	Z phase number	
SFD927	CLR signal delay time	Default is 20, unit: ms
SFD928	Grinding wheel radius (polar coordinates)	Low 16-bit
SFD929		High 16-bit
SFD930	Soft limit positive value	Low 16-bit
SFD931		High 16-bit
SFD932	Soft limit negative value	Low 16-bit
SFD933		High 16-bit
...		
<b>Y0 (group 1 parameters)</b>		
SFD950	Pulse default speed low 16-bit	Pulse is sent at the default speed when the speed is 0.
SFD951	Pulse default speed high 16-bit	
SFD952	Acceleration time of pulse default speed	
SFD953	deceleration time of pulse default speed	
SFD954	Accerlation and deceleration time	



SFD955	Acceleration/deceleration mode	Bit1~Bit0: acc/dec mode 00: linear acc/dec 01: S curve acc/dec 10: sine curve acc/dec 11: reserved Bit15~Bit2: reserved
SFD956	Max speed low 16-bit	
SFD957	Max speed high 16-bit	
SFD958	Initial speed low 16-bit	
SFD959	Initial speed high 16-bit	
SFD960	Stop speed low 16-bit	
SFD961	Stop speed high 16-bit	
SFD962	Follow performance	1~100, 100 means the time constant is 1 Tick, 1 means the time constant is 100 Ticks
SFD963	Follow feedforward compensation	0~100, %
...		
<b>Y0 (group 2 parameters)</b>		
SFD970	Pulse default speed low 16-bit	Pulse is sent at the default speed when the speed is 0.
SFD971	Pulse default speed high 16-bit	
SFD972	Acceleration time of pulse default speed	
SFD973	deceleration time of pulse default speed	
SFD974	Accerlation and deceleration time	
SFD975	Acceleration/deceleration mode	Bit1~Bit0: acc/dec mode 00: linear acc/dec 01: S curve acc/dec 10: sine curve acc/dec 11: reserved Bit15~Bit2: reserved
SFD976	Max speed low 16-bit	
SFD977	Max speed high 16-bit	
SFD978	Initial speed low 16-bit	
SFD979	Initial speed high 16-bit	
SFD980	Stop speed low 16-bit	
SFD981	Stop speed high 16-bit	
SFD982	Follow performance	1~100, 100 means the time constant is 1 Tick, 1 means the time constant is 100 Ticks
SFD983	Follow feedforward compensation	0~100, %
...		
<b>Y0 (group 3 parameters)</b>		
SFD990	Pulse default speed low 16-bit	Pulse is sent at the default speed when the speed is 0.
SFD991	Pulse default speed high 16-bit	

SFD992	Acceleration time of pulse default speed	
SFD993	deceleration time of pulse default speed	
SFD994	Accerlation and deceleration time	
SFD995	Acceleration/deceleration mode	Bit1~Bit0: acc/dec mode 00: linear acc/dec 01: S curve acc/dec 10: sine curve acc/dec 11: reserved Bit15~Bit2: reserved
SFD996	Max speed low 16-bit	
SFD997	Max speed high 16-bit	
SFD998	Initial speed low 16-bit	
SFD999	Initial speed high 16-bit	
SFD1000	Stop speed low 16-bit	
SFD1001	Stop speed high 16-bit	
SFD1002	Follow performance	1~100, 100 means the time constant is 1 Tick, 1 means the time constant is 100 Ticks
SFD1003	Follow feedforward compensation	0~100, %
...		
<b>Y0 (group 4 parameters)</b>		
SFD1010	Pulse default speed low 16-bit	Pulse is sent at the default speed when the speed is 0.
SFD1011	Pulse default speed high 16-bit	
SFD1012	Acceleration time of pulse default speed	
SFD1013	deceleration time of pulse default speed	
SFD1014	Accerlation and deceleration time	
SFD1015	Acceleration/deceleration mode	Bit1~Bit0: acc/dec mode 00: linear acc/dec 01: S curve acc/dec 10: sine curve acc/dec 11: reserved Bit15~Bit2: reserved
SFD1016	Max speed low 16-bit	
SFD1017	Max speed high 16-bit	
SFD1018	Initial speed low 16-bit	
SFD1019	Initial speed high 16-bit	
SFD1020	Stop speed low 16-bit	
SFD1021	Stop speed high 16-bit	
SFD1022	Follow performance	1~100, 100 means the time constant is 1 Tick, 1 means the time constant is 100 Ticks

SFD1023	Follow feedforward compensation	0~100, %
...		
<b>Y1 (common parameters)</b>		
SFD1030	Pulse parameters	Same to SFD900
SFD1031	Pulse sending mode	Bit 0: pulse sending mode 0: complete mode; 1: continue mode Default is 0
SFD1032	Pulse number/1 rotation low 16-bit	
SFD1033	Pulse number/1 rotation high 16-bit	
SFD1034	Moving amount/1 rotation low 16-bit	
SFD1035	Moving amount/1 rotation high 16-bit	
SFD1036	Pulse direction terminal	Appoint to Y terminal, 0xFF is no terminal
SFD1037	Direction delay time	Default is 20, unit: ms
SFD1038	Gear clearance positive compensation	
SFD1039	Gear clearance negative compensation	
SFD1040	Electrical origin position low 16-bit	
SFD1041	Electrical origin position high 16-bit	
SFD1042	Signal terminal switch state	Bit0: Origin Signal Switch State Settings Bit1: Z Phase Switch State Settings Bit2: Positive Limit Switching State Settings Bit3: Negative Limit Switching State Settings 0: Normally open (positive logic), 1: Normally closed (negative logic); default is 0
SFD1044	Near-point signal terminal setting	
SFD1045	Z phase terminal setting	Bit0~Bit7: Specify the number of the X terminal, 0xFF is no terminal
SFD1047	Limit terminal setting	Bit7~Bit0: Specifies the X terminal number of the positive limit, and 0xFF is no terminal. Bit15~Bit8: Specifies the X terminal number of the negative limit, and 0xFF is no terminal.
SFD1048	Zero clear CLR output signal	
SFD1049	Return speed VH low 16-bit	Bit0~Bit7: Specify the number of the Y terminal, 0xFF is no terminal
SFD1052	Return speed VH high 16-bit	
SFD1053	Creeping speed VC low 16-bit	
SFD1054	Creeping speed VC high 16-bit	
SFD1055	Mechanical origin position low 16-bit	

SFD1056	Mechanical origin position high 16-bit	
SFD1057	Z phase number	
SFD1058	CLR signal delay time	Default is 20, unit: ms
SFD1059	Grinding wheel radius (polar coordinates)	Low 16-bit
SFD1060		High 16-bit
SFD1061	Soft limit positive value	Low 16-bit
SFD1062		High 16-bit
SFD1063	Soft limit negative value	Low 16-bit
...		
<b>Y1 (group 1 parameters)</b>		
SFD1080	Pulse default speed low 16-bit	Pulse is sent at the default speed when the speed is 0.
SFD1081	Pulse default speed high 16-bit	
SFD1082	Acceleration time of pulse default speed	
SFD1083	deceleration time of pulse default speed	
SFD1084	Accerlation and deceleration time	
SFD1085	Acceleration/deceleration mode	Bit1~Bit0: acc/dec mode 00: linear acc/dec 01: S curve acc/dec 10: sine curve acc/dec 11: reserved Bit15~Bit2: reserved
SFD1086	Max speed low 16-bit	
SFD1087	Max speed high 16-bit	
SFD1088	Initial speed low 16-bit	
SFD1089	Initial speed high 16-bit	
SFD1090	Stop speed low 16-bit	
SFD1091	Stop speed high 16-bit	
SFD1092	Follow performance	1~100, 100 means the time constant is 1 Tick, 1 means the time constant is 100 Ticks
SFD1093	Follow feedforward compensation	0~100, %
...		
<b>Y1 (group 2 parameters)</b>		
SFD1100	Pulse default speed low 16-bit	Pulse is sent at the default speed when the speed is 0.
SFD1101	Pulse default speed high 16-bit	
SFD1102	Acceleration time of pulse default speed	
SFD1103	deceleration time of pulse default speed	
SFD1104	Accerlation and deceleration time	

SFD1105	Acceleration/deceleration mode	Bit1~Bit0: acc/dec mode 00: linear acc/dec 01: S curve acc/dec 10: sine curve acc/dec 11: reserved Bit15~Bit2: reserved
SFD1106	Max speed low 16-bit	
SFD1107	Max speed high 16-bit	
SFD1108	Initial speed low 16-bit	
SFD1109	Initial speed high 16-bit	
SFD1110	Stop speed low 16-bit	
SFD1111	Stop speed high 16-bit	
SFD1112	Follow performance	1~100, 100 means the time constant is 1 Tick, 1 means the time constant is 100 Ticks
SFD1113	Follow feedforward compensation	0~100, %
...		
<b>Y1 (group 3 parameters)</b>		
SFD1120	Pulse default speed low 16-bit	Pulse is sent at the default speed when the speed is 0.
SFD1121	Pulse default speed high 16-bit	
SFD1122	Acceleration time of pulse default speed	
SFD1123	deceleration time of pulse default speed	
SFD1124	Accerlation and deceleration time	
SFD1125	Acceleration/deceleration mode	Bit1~Bit0: acc/dec mode 00: linear acc/dec 01: S curve acc/dec 10: sine curve acc/dec 11: reserved Bit15~Bit2: reserved
SFD1126	Max speed low 16-bit	
SFD1127	Max speed high 16-bit	
SFD1128	Initial speed low 16-bit	
SFD1129	Initial speed high 16-bit	
SFD1130	Stop speed low 16-bit	
SFD1131	Stop speed high 16-bit	
SFD1132	Follow performance	1~100, 100 means the time constant is 1 Tick, 1 means the time constant is 100 Ticks
SFD1133	Follow feedforward compensation	0~100, %
...		
<b>Y1 (group 4 parameters)</b>		
SFD1140	Pulse default speed low 16-bit	Pulse is sent at the default speed when the speed is 0.
SFD1141	Pulse default speed high 16-bit	

SFD1142	Acceleration time of pulse default speed	
SFD1143	deceleration time of pulse default speed	
SFD1144	Accerlation and deceleration time	
SFD1145	Acceleration/deceleration mode	Bit1~Bit0: acc/dec mode 00: linear acc/dec 01: S curve acc/dec 10: sine curve acc/dec 11: reserved Bit15~Bit2: reserved
SFD1146	Max speed low 16-bit	
SFD1147	Max speed high 16-bit	
SFD1148	Initial speed low 16-bit	
SFD1149	Initial speed high 16-bit	
SFD1150	Stop speed low 16-bit	
SFD1151	Stop speed high 16-bit	
SFD1152	Follow performance	1~100, 100 means the time constant is 1 Tick, 1 means the time constant is 100 Ticks
SFD1153	Follow feedforward compensation	0~100, %
...		
<b>Y2 (common parameters)</b>		
SFD1160	Pulse parameters	Same to SFD900
SFD1161	Pulse sending mode	Bit 0: pulse sending mode 0: complete mode; 1: continue mode Default is 0
SFD1162	Pulse number/1 rotation low 16-bit	
SFD1163	Pulse number/1 rotation high 16-bit	
SFD1164	Moving amount/1 rotation low 16-bit	
SFD1165	Moving amount/1 rotation high 16-bit	
SFD1166	Pulse direction terminal	Appoint to Y terminal, 0xFF is no terminal
SFD1167	Direction delay time	Default is 20, unit: ms
SFD1168	Gear clearance positive compensation	
SFD1169	Gear clearance negative compensation	
SFD1170	Electrical origin position low 16-bit	
SFD1171	Electrical origin position high 16-bit	

SFD1172	Signal terminal switch state	Bit0: Origin Signal Switch State Settings Bit1: Z Phase Switch State Settings Bit2: Positive Limit Switching State Settings Bit3: Negative Limit Switching State Settings 0: Normally open (positive logic), 1: Normally closed (negative logic); default is 0
SFD1174	Near-point signal terminal setting	
SFD1175	Z phase terminal setting	Bit0~Bit7: Specify the number of the X terminal, 0xFF is no terminal
SFD1177	Limit terminal setting	Bit7~Bit0: Specifies the X terminal number of the positive limit, and 0xFF is no terminal. Bit15~Bit8: Specifies the X terminal number of the negative limit, and 0xFF is no terminal.
SFD1178	Zero clear CLR output signal	Bit0~Bit7: Specify the number of the Y terminal, 0xFF is no terminal
SFD1179	Return speed VH low 16-bit	
SFD1182	Return speed VH high 16-bit	
SFD1183	Creeping speed VC low 16-bit	
SFD1184	Creeping speed VC high 16-bit	
SFD1185	Mechanical origin position low 16-bit	
SFD1186	Mechanical origin position high 16-bit	
SFD1187	Z phase number	
SFD1188	CLR signal delay time	Default is 20, unit: ms
SFD1189	Grinding wheel radius (polar coordinates)	Low 16-bit
SFD1190		High 16-bit
SFD1191	Soft limit positive value	Low 16-bit
SFD1192		High 16-bit
SFD1193	Soft limit negative value	Low 16-bit
...		
<b>Y2 (group 1 parameters)</b>		
SFD1210	Pulse default speed low 16-bit	Pulse is sent at the default speed when the speed is 0.
SFD1211	Pulse default speed high 16-bit	
SFD1212	Acceleration time of pulse default speed	
SFD1213	deceleration time of pulse default speed	
SFD1214	Accerlation and deceleration time	

SFD1215	Acceleration/deceleration mode	Bit1~Bit0: acc/dec mode 00: linear acc/dec 01: S curve acc/dec 10: sine curve acc/dec 11: reserved Bit15~Bit2: reserved
SFD1216	Max speed low 16-bit	
SFD1217	Max speed high 16-bit	
SFD1218	Initial speed low 16-bit	
SFD1219	Initial speed high 16-bit	
SFD1220	Stop speed low 16-bit	
SFD1221	Stop speed high 16-bit	
SFD1222	Follow performance	1~100, 100 means the time constant is 1 Tick, 1 means the time constant is 100 Ticks
SFD1223	Follow feedforward compensation	0~100, %
...		
<b>Y2 (group 2 parameters)</b>		
SFD1230	Pulse default speed low 16-bit	Pulse is sent at the default speed when the speed is 0.
SFD1231	Pulse default speed high 16-bit	
SFD1232	Acceleration time of pulse default speed	
SFD1233	deceleration time of pulse default speed	
SFD1234	Accerlation and deceleration time	
SFD1235	Acceleration/deceleration mode	Bit1~Bit0: acc/dec mode 00: linear acc/dec 01: S curve acc/dec 10: sine curve acc/dec 11: reserved Bit15~Bit2: reserved
SFD1236	Max speed low 16-bit	
SFD1237	Max speed high 16-bit	
SFD1238	Initial speed low 16-bit	
SFD1239	Initial speed high 16-bit	
SFD1240	Stop speed low 16-bit	
SFD1241	Stop speed high 16-bit	
SFD1242	Follow performance	1~100, 100 means the time constant is 1 Tick, 1 means the time constant is 100 Ticks
SFD1243	Follow feedforward compensation	0~100, %
...		
<b>Y2 (group 3 parameters)</b>		
SFD1250	Pulse default speed low 16-bit	Pulse is sent at the default speed when the speed is 0.
SFD1251	Pulse default speed high 16-bit	



SFD1252	Acceleration time of pulse default speed	
SFD1253	deceleration time of pulse default speed	
SFD1254	Accerlation and deceleration time	
SFD1255	Acceleration/deceleration mode	Bit1~Bit0: acc/dec mode 00: linear acc/dec 01: S curve acc/dec 10: sine curve acc/dec 11: reserved Bit15~Bit2: reserved
SFD1256	Max speed low 16-bit	
SFD1257	Max speed high 16-bit	
SFD1258	Initial speed low 16-bit	
SFD1259	Initial speed high 16-bit	
SFD1260	Stop speed low 16-bit	
SFD1261	Stop speed high 16-bit	
SFD1262	Follow performance	1~100, 100 means the time constant is 1 Tick, 1 means the time constant is 100 Ticks
SFD1263	Follow feedforward compensation	0~100, %
...		
<b>Y2 (group 4 parameters)</b>		
SFD1270	Pulse default speed low 16-bit	Pulse is sent at the default speed when the speed is 0.
SFD1271	Pulse default speed high 16-bit	
SFD1272	Acceleration time of pulse default speed	
SFD1273	deceleration time of pulse default speed	
SFD1274	Accerlation and deceleration time	
SFD1275	Acceleration/deceleration mode	Bit1~Bit0: acc/dec mode 00: linear acc/dec 01: S curve acc/dec 10: sine curve acc/dec 11: reserved Bit15~Bit2: reserved
SFD1276	Max speed low 16-bit	
SFD1277	Max speed high 16-bit	
SFD1278	Initial speed low 16-bit	
SFD1279	Initial speed high 16-bit	
SFD1280	Stop speed low 16-bit	
SFD1281	Stop speed high 16-bit	
SFD1282	Follow performance	1~100, 100 means the time constant is 1 Tick, 1 means the time constant is 100 Ticks

SFD1283	Follow feedforward compensation	0~100, %
...		
<b>Y3 (common parameters)</b>		
SFD1290	Pulse parameters	Same to SFD900
SFD1291	Pulse sending mode	Bit 0: pulse sending mode 0: complete mode; 1: continue mode Default is 0
SFD1292	Pulse number/1 rotation low 16-bit	
SFD1293	Pulse number/1 rotation high 16-bit	
SFD1294	Moving amount/1 rotation low 16-bit	
SFD1295	Moving amount/1 rotation high 16-bit	
SFD1296	Pulse direction terminal	Appoint to Y terminal, 0xFF is no terminal
SFD1297	Direction delay time	Default is 20, unit: ms
SFD1298	Gear clearance positive compensation	
SFD1299	Gear clearance negative compensation	
SFD1300	Electrical origin position low 16-bit	
SFD1301	Electrical origin position high 16-bit	
SFD1302	Signal terminal switch state	Bit0: Origin Signal Switch State Settings Bit1: Z Phase Switch State Settings Bit2: Positive Limit Switching State Settings Bit3: Negative Limit Switching State Settings 0: Normally open (positive logic), 1: Normally closed (negative logic); default is 0
SFD1304	Near-point signal terminal setting	
SFD1305	Z phase terminal setting	Bit0~Bit7: Specify the number of the X terminal, 0xFF is no terminal
SFD1307	Limit terminal setting	Bit7~Bit0: Specifies the X terminal number of the positive limit, and 0xFF is no terminal. Bit15~Bit8: Specifies the X terminal number of the negative limit, and 0xFF is no terminal.
SFD1308	Zero clear CLR output signal	Bit0~Bit7: Specify the number of the Y terminal, 0xFF is no terminal
SFD1309	Return speed VH low 16-bit	
SFD1312	Return speed VH high 16-bit	
SFD1313	Creeping speed VC low 16-bit	
SFD1314	Creeping speed VC high 16-bit	
SFD1315	Mechanical origin position low 16-bit	

SFD1316	Mechanical origin position high 16-bit	
SFD1317	Z phase number	
SFD1318	CLR signal delay time	Default is 20, unit: ms
SFD1319	Grinding wheel radius (polar coordinates)	Low 16-bit
SFD1320		High 16-bit
SFD1321	Soft limit positive value	Low 16-bit
SFD1322		High 16-bit
SFD1323	Soft limit negative value	Low 16-bit
...		
<b>Y3 (group 1 parameters)</b>		
SFD1340	Pulse default speed low 16-bit	Pulse is sent at the default speed when the speed is 0.
SFD1341	Pulse default speed high 16-bit	
SFD1342	Acceleration time of pulse default speed	
SFD1343	deceleration time of pulse default speed	
SFD1344	Accerlation and deceleration time	
SFD1345	Acceleration/deceleration mode	Bit1~Bit0: acc/dec mode 00: linear acc/dec 01: S curve acc/dec 10: sine curve acc/dec 11: reserved Bit15~Bit2: reserved
SFD1346	Max speed low 16-bit	
SFD1347	Max speed high 16-bit	
SFD1348	Initial speed low 16-bit	
SFD1349	Initial speed high 16-bit	
SFD1350	Stop speed low 16-bit	
SFD1351	Stop speed high 16-bit	
SFD1352	Follow performance	1~100, 100 means the time constant is 1 Tick, 1 means the time constant is 100 Ticks
SFD1353	Follow feedforward compensation	0~100, %
...		
<b>Y3 (group 2 parameters)</b>		
SFD1360	Pulse default speed low 16-bit	Pulse is sent at the default speed when the speed is 0.
SFD1361	Pulse default speed high 16-bit	
SFD1362	Acceleration time of pulse default speed	
SFD1363	deceleration time of pulse default speed	
SFD1364	Accerlation and deceleration time	

SFD1365	Acceleration/deceleration mode	Bit1~Bit0: acc/dec mode 00: linear acc/dec 01: S curve acc/dec 10: sine curve acc/dec 11: reserved Bit15~Bit2: reserved
SFD1366	Max speed low 16-bit	
SFD1367	Max speed high 16-bit	
SFD1368	Initial speed low 16-bit	
SFD1369	Initial speed high 16-bit	
SFD1370	Stop speed low 16-bit	
SFD1371	Stop speed high 16-bit	
SFD1372	Follow performance	1~100, 100 means the time constant is 1 Tick, 1 means the time constant is 100 Ticks
SFD1373	Follow feedforward compensation	0~100, %
...		
<b>Y3 (group 3 parameters)</b>		
SFD1380	Pulse default speed low 16-bit	Pulse is sent at the default speed when the speed is 0.
SFD1381	Pulse default speed high 16-bit	
SFD1382	Acceleration time of pulse default speed	
SFD1383	deceleration time of pulse default speed	
SFD1384	Accerlation and deceleration time	
SFD1385	Acceleration/deceleration mode	Bit1~Bit0: acc/dec mode 00: linear acc/dec 01: S curve acc/dec 10: sine curve acc/dec 11: reserved Bit15~Bit2: reserved
SFD1386	Max speed low 16-bit	
SFD1387	Max speed high 16-bit	
SFD1388	Initial speed low 16-bit	
SFD1389	Initial speed high 16-bit	
SFD1390	Stop speed low 16-bit	
SFD1391	Stop speed high 16-bit	
SFD1392	Follow performance	1~100, 100 means the time constant is 1 Tick, 1 means the time constant is 100 Ticks
SFD1393	Follow feedforward compensation	0~100, %
...		
<b>Y3 (group 4 parameters)</b>		
SFD1400	Pulse default speed low 16-bit	Pulse is sent at the default speed when the speed is 0.
SFD1401	Pulse default speed high 16-bit	

SFD1402	Acceleration time of pulse default speed	
SFD1403	deceleration time of pulse default speed	
SFD1404	Accerlation and deceleration time	
SFD1405	Acceleration/deceleration mode	Bit1~Bit0: acc/dec mode 00: linear acc/dec 01: S curve acc/dec 10: sine curve acc/dec 11: reserved Bit15~Bit2: reserved
SFD1406	Max speed low 16-bit	
SFD1407	Max speed high 16-bit	
SFD1408	Initial speed low 16-bit	
SFD1409	Initial speed high 16-bit	
SFD1410	Stop speed low 16-bit	
SFD1411	Stop speed high 16-bit	
SFD1412	Follow performance	1~100, 100 means the time constant is 1 Tick, 1 means the time constant is 100 Ticks
SFD1413	Follow feedforward compensation	0~100, %
...		
<b>Y4 (common parameters)</b>		
SFD1420	Pulse parameters	Same to SFD900
SFD1421	Pulse sending mode	Bit 0: pulse sending mode 0: complete mode; 1: continue mode Default is 0
SFD1422	Pulse number/1 rotation low 16-bit	
SFD1423	Pulse number/1 rotation high 16-bit	
SFD1424	Moving amount/1 rotation low 16-bit	
SFD1425	Moving amount/1 rotation high 16-bit	
SFD1426	Pulse direction terminal	Appoint to Y terminal, 0xFF is no terminal
SFD1427	Direction delay time	Default is 20, unit: ms
SFD1428	Gear clearance positive compensation	
SFD1429	Gear clearance negative compensation	
SFD1430	Electrical origin position low 16-bit	
SFD1431	Electrical origin position high 16-bit	

SFD1432	Signal terminal switch state	Bit0: Origin Signal Switch State Settings Bit1: Z Phase Switch State Settings Bit2: Positive Limit Switching State Settings Bit3: Negative Limit Switching State Settings 0: Normally open (positive logic), 1: Normally closed (negative logic); default is 0
SFD1434	Near-point signal terminal setting	
SFD1435	Z phase terminal setting	Bit0~Bit7: Specify the number of the X terminal, 0xFF is no terminal
SFD1437	Limit terminal setting	Bit7~Bit0: Specifies the X terminal number of the positive limit, and 0xFF is no terminal. Bit15~Bit8: Specifies the X terminal number of the negative limit, and 0xFF is no terminal.
SFD1438	Zero clear CLR output signal	Bit0~Bit7: Specify the number of the Y terminal, 0xFF is no terminal
SFD1439	Return speed VH low 16-bit	
SFD1442	Return speed VH high 16-bit	
SFD1443	Creeping speed VC low 16-bit	
SFD1444	Creeping speed VC high 16-bit	
SFD1445	Mechanical origin position low 16-bit	
SFD1446	Mechanical origin position high 16-bit	
SFD1447	Z phase number	
SFD1448	CLR signal delay time	Default is 20, unit: ms
SFD1449	Grinding wheel radius (polar coordinates)	Low 16-bit
SFD1450		High 16-bit
SFD1451	Soft limit positive value	Low 16-bit
SFD1452		High 16-bit
SFD1453	Soft limit negative value	Low 16-bit
...		
<b>Y4 (group 1 parameters)</b>		
SFD1470	Pulse default speed low 16-bit	Pulse is sent at the default speed when the speed is 0.
SFD1471	Pulse default speed high 16-bit	
SFD1472	Acceleration time of pulse default speed	
SFD1473	deceleration time of pulse default speed	
SFD1474	Accerlation and deceleration time	

SFD1475	Acceleration/deceleration mode	Bit1~Bit0: acc/dec mode 00: linear acc/dec 01: S curve acc/dec 10: sine curve acc/dec 11: reserved Bit15~Bit2: reserved
SFD1476	Max speed low 16-bit	
SFD1477	Max speed high 16-bit	
SFD1478	Initial speed low 16-bit	
SFD1479	Initial speed high 16-bit	
SFD1480	Stop speed low 16-bit	
SFD1481	Stop speed high 16-bit	
SFD1482	Follow performance	1~100, 100 means the time constant is 1 Tick, 1 means the time constant is 100 Ticks
SFD1483	Follow feedforward compensation	0~100, %
...		
<b>Y4 (group 2 parameters)</b>		
SFD1490	Pulse default speed low 16-bit	Pulse is sent at the default speed when the speed is 0.
SFD1491	Pulse default speed high 16-bit	
SFD1492	Acceleration time of pulse default speed	
SFD1493	deceleration time of pulse default speed	
SFD1494	Accerlation and deceleration time	
SFD1495	Acceleration/deceleration mode	Bit1~Bit0: acc/dec mode 00: linear acc/dec 01: S curve acc/dec 10: sine curve acc/dec 11: reserved Bit15~Bit2: reserved
SFD1496	Max speed low 16-bit	
SFD1497	Max speed high 16-bit	
SFD1498	Initial speed low 16-bit	
SFD1499	Initial speed high 16-bit	
SFD1500	Stop speed low 16-bit	
SFD1501	Stop speed high 16-bit	
SFD1502	Follow performance	1~100, 100 means the time constant is 1 Tick, 1 means the time constant is 100 Ticks
SFD1503	Follow feedforward compensation	0~100, %
...		
<b>Y4 (group 3 parameters)</b>		
SFD1510	Pulse default speed low 16-bit	Pulse is sent at the default speed when the speed is 0.
SFD1511	Pulse default speed high 16-bit	

SFD1512	Acceleration time of pulse default speed	
SFD1513	deceleration time of pulse default speed	
SFD1514	Accerlation and deceleration time	
SFD1515	Acceleration/deceleration mode	Bit1~Bit0: acc/dec mode 00: linear acc/dec 01: S curve acc/dec 10: sine curve acc/dec 11: reserved Bit15~Bit2: reserved
SFD1516	Max speed low 16-bit	
SFD1517	Max speed high 16-bit	
SFD1518	Initial speed low 16-bit	
SFD1519	Initial speed high 16-bit	
SFD1520	Stop speed low 16-bit	
SFD1521	Stop speed high 16-bit	
SFD1522	Follow performance	1~100, 100 means the time constant is 1 Tick, 1 means the time constant is 100 Ticks
SFD1523	Follow feedforward compensation	0~100, %
...		
<b>Y4 (group 4 parameters)</b>		
SFD1530	Pulse default speed low 16-bit	Pulse is sent at the default speed when the speed is 0.
SFD1531	Pulse default speed high 16-bit	
SFD1532	Acceleration time of pulse default speed	
SFD1533	deceleration time of pulse default speed	
SFD1534	Accerlation and deceleration time	
SFD1535	Acceleration/deceleration mode	Bit1~Bit0: acc/dec mode 00: linear acc/dec 01: S curve acc/dec 10: sine curve acc/dec 11: reserved Bit15~Bit2: reserved
SFD1536	Max speed low 16-bit	
SFD1537	Max speed high 16-bit	
SFD1538	Initial speed low 16-bit	
SFD1539	Initial speed high 16-bit	
SFD1540	Stop speed low 16-bit	
SFD1541	Stop speed high 16-bit	
SFD1542	Follow performance	1~100, 100 means the time constant is 1 Tick, 1 means the time constant is 100 Ticks



SFD1543	Follow feedforward compensation	0~100, %
...		
<b>Y5 (common parameters)</b>		
SFD1550	Pulse parameters	Same to SFD900
SFD1551	Pulse sending mode	Bit 0: pulse sending mode 0: complete mode; 1: continue mode Default is 0
SFD1552	Pulse number/1 rotation low 16-bit	
SFD1553	Pulse number/1 rotation high 16-bit	
SFD1554	Moving amount/1 rotation low 16-bit	
SFD1555	Moving amount/1 rotation high 16-bit	
SFD1556	Pulse direction terminal	Appoint to Y terminal, 0xFF is no terminal
SFD1557	Direction delay time	Default is 20, unit: ms
SFD1558	Gear clearance positive compensation	
SFD1559	Gear clearance negative compensation	
SFD1560	Electrical origin position low 16-bit	
SFD1561	Electrical origin position high 16-bit	
SFD1562	Signal terminal switch state	Bit0: Origin Signal Switch State Settings Bit1: Z Phase Switch State Settings Bit2: Positive Limit Switching State Settings Bit3: Negative Limit Switching State Settings 0: Normally open (positive logic), 1: Normally closed (negative logic); default is 0
SFD1564	Near-point signal terminal setting	
SFD1565	Z phase terminal setting	Bit0~Bit7: Specify the number of the X terminal, 0xFF is no terminal
SFD1567	Limit terminal setting	Bit7~Bit0: Specifies the X terminal number of the positive limit, and 0xFF is no terminal. Bit15~Bit8: Specifies the X terminal number of the negative limit, and 0xFF is no terminal.
SFD1568	Zero clear CLR output signal	
SFD1569	Return speed VH low 16-bit	Bit0~Bit7: Specify the number of the Y terminal, 0xFF is no terminal
SFD1572	Return speed VH high 16-bit	
SFD1573	Creeping speed VC low 16-bit	
SFD1574	Creeping speed VC high 16-bit	
SFD1575	Mechanical origin position low 16-bit	

SFD1576	Mechanical origin position high 16-bit	
SFD1577	Z phase number	
SFD1578	CLR signal delay time	Default is 20, unit: ms
SFD1579	Grinding wheel radius (polar coordinates)	Low 16-bit
SFD1580		High 16-bit
SFD1581	Soft limit positive value	Low 16-bit
SFD1582		High 16-bit
SFD1583	Soft limit negative value	Low 16-bit
...		
<b>Y5 (group 1 parameters)</b>		
SFD1600	Pulse default speed low 16-bit	Pulse is sent at the default speed when the speed is 0.
SFD1601	Pulse default speed high 16-bit	
SFD1602	Acceleration time of pulse default speed	
SFD1603	deceleration time of pulse default speed	
SFD1604	Accerlation and deceleration time	
SFD1605	Acceleration/deceleration mode	Bit1~Bit0: acc/dec mode 00: linear acc/dec 01: S curve acc/dec 10: sine curve acc/dec 11: reserved Bit15~Bit2: reserved
SFD1606	Max speed low 16-bit	
SFD1607	Max speed high 16-bit	
SFD1608	Initial speed low 16-bit	
SFD1609	Initial speed high 16-bit	
SFD1610	Stop speed low 16-bit	
SFD1611	Stop speed high 16-bit	
SFD1612	Follow performance	1~100, 100 means the time constant is 1 Tick, 1 means the time constant is 100 Ticks
SFD1613	Follow feedforward compensation	0~100, %
...		
<b>Y5 (group 2 parameters)</b>		
SFD1620	Pulse default speed low 16-bit	Pulse is sent at the default speed when the speed is 0.
SFD1621	Pulse default speed high 16-bit	
SFD1622	Acceleration time of pulse default speed	
SFD1623	deceleration time of pulse default speed	
SFD1624	Accerlation and deceleration time	

SFD1625	Acceleration/deceleration mode	Bit1~Bit0: acc/dec mode 00: linear acc/dec 01: S curve acc/dec 10: sine curve acc/dec 11: reserved Bit15~Bit2: reserved
SFD1626	Max speed low 16-bit	
SFD1627	Max speed high 16-bit	
SFD1628	Initial speed low 16-bit	
SFD1629	Initial speed high 16-bit	
SFD1630	Stop speed low 16-bit	
SFD1631	Stop speed high 16-bit	
SFD1632	Follow performance	1~100, 100 means the time constant is 1 Tick, 1 means the time constant is 100 Ticks
SFD1633	Follow feedforward compensation	0~100, %
...		
<b>Y5 (group 3 parameters)</b>		
SFD1640	Pulse default speed low 16-bit	Pulse is sent at the default speed when the speed is 0.
SFD1641	Pulse default speed high 16-bit	
SFD1642	Acceleration time of pulse default speed	
SFD1643	deceleration time of pulse default speed	
SFD1644	Accerlation and deceleration time	
SFD1645	Acceleration/deceleration mode	Bit1~Bit0: acc/dec mode 00: linear acc/dec 01: S curve acc/dec 10: sine curve acc/dec 11: reserved Bit15~Bit2: reserved
SFD1646	Max speed low 16-bit	
SFD1647	Max speed high 16-bit	
SFD1648	Initial speed low 16-bit	
SFD1649	Initial speed high 16-bit	
SFD1650	Stop speed low 16-bit	
SFD1651	Stop speed high 16-bit	
SFD1652	Follow performance	1~100, 100 means the time constant is 1 Tick, 1 means the time constant is 100 Ticks
SFD1653	Follow feedforward compensation	0~100, %
...		
<b>Y5 (group 4 parameters)</b>		
SFD1660	Pulse default speed low 16-bit	Pulse is sent at the default speed when the speed is 0.
SFD1661	Pulse default speed high 16-bit	

SFD1662	Acceleration time of pulse default speed	
SFD1663	deceleration time of pulse default speed	
SFD1664	Accerlation and deceleration time	
SFD1665	Acceleration/deceleration mode	Bit1~Bit0: acc/dec mode 00: linear acc/dec 01: S curve acc/dec 10: sine curve acc/dec 11: reserved Bit15~Bit2: reserved
SFD1666	Max speed low 16-bit	
SFD1667	Max speed high 16-bit	
SFD1668	Initial speed low 16-bit	
SFD1669	Initial speed high 16-bit	
SFD1670	Stop speed low 16-bit	
SFD1671	Stop speed high 16-bit	
SFD1672	Follow performance	1~100, 100 means the time constant is 1 Tick, 1 means the time constant is 100 Ticks
SFD1673	Follow feedforward compensation	0~100, %
...		
<b>Y6 (common parameters)</b>		
SFD1680	Pulse parameters	Same to SFD900
SFD1681	Pulse sending mode	Bit 0: pulse sending mode 0: complete mode; 1: continue mode Default is 0
SFD1682	Pulse number/1 rotation low 16-bit	
SFD1683	Pulse number/1 rotation high 16-bit	
SFD1684	Moving amount/1 rotation low 16-bit	
SFD1685	Moving amount/1 rotation high 16-bit	
SFD1686	Pulse direction terminal	Appoint to Y terminal, 0xFF is no terminal
SFD1687	Direction delay time	Default is 20, unit: ms
SFD1688	Gear clearance positive compensation	
SFD1689	Gear clearance negative compensation	
SFD1690	Electrical origin position low 16-bit	
SFD1691	Electrical origin position high 16-bit	

SFD1692	Signal terminal switch state	Bit0: Origin Signal Switch State Settings Bit1: Z Phase Switch State Settings Bit2: Positive Limit Switching State Settings Bit3: Negative Limit Switching State Settings 0: Normally open (positive logic), 1: Normally closed (negative logic); default is 0
SFD1694	Near-point signal terminal setting	
SFD1695	Z phase terminal setting	Bit0~Bit7: Specify the number of the X terminal, 0xFF is no terminal
SFD1697	Limit terminal setting	Bit7~Bit0: Specifies the X terminal number of the positive limit, and 0xFF is no terminal. Bit15~Bit8: Specifies the X terminal number of the negative limit, and 0xFF is no terminal.
SFD1698	Zero clear CLR output signal	Bit0~Bit7: Specify the number of the Y terminal, 0xFF is no terminal
SFD1699	Return speed VH low 16-bit	
SFD1702	Return speed VH high 16-bit	
SFD1703	Creeping speed VC low 16-bit	
SFD1704	Creeping speed VC high 16-bit	
SFD1705	Mechanical origin position low 16-bit	
SFD1706	Mechanical origin position high 16-bit	
SFD1707	Z phase number	
SFD1708	CLR signal delay time	Default is 20, unit: ms
SFD1709	Grinding wheel radius (polar coordinates)	Low 16-bit
SFD1710		High 16-bit
SFD1711	Soft limit positive value	Low 16-bit
SFD1712		High 16-bit
SFD1713	Soft limit negative value	Low 16-bit
...		
<b>Y6 (group 1 parameters)</b>		
SFD1730	Pulse default speed low 16-bit	Pulse is sent at the default speed when the speed is 0.
SFD1731	Pulse default speed high 16-bit	
SFD1732	Acceleration time of pulse default speed	
SFD1733	deceleration time of pulse default speed	
SFD1734	Accerlation and deceleration time	

SFD1735	Acceleration/deceleration mode	Bit1~Bit0: acc/dec mode 00: linear acc/dec 01: S curve acc/dec 10: sine curve acc/dec 11: reserved Bit15~Bit2: reserved
SFD1736	Max speed low 16-bit	
SFD1737	Max speed high 16-bit	
SFD1738	Initial speed low 16-bit	
SFD1739	Initial speed high 16-bit	
SFD1740	Stop speed low 16-bit	
SFD1741	Stop speed high 16-bit	
SFD1742	Follow performance	1~100, 100 means the time constant is 1 Tick, 1 means the time constant is 100 Ticks
SFD1743	Follow feedforward compensation	0~100, %
...		
<b>Y6 (group 2 parameters)</b>		
SFD1750	Pulse default speed low 16-bit	Pulse is sent at the default speed when the speed is 0.
SFD1751	Pulse default speed high 16-bit	
SFD1752	Acceleration time of pulse default speed	
SFD1753	deceleration time of pulse default speed	
SFD1754	Accerlation and deceleration time	
SFD1755	Acceleration/deceleration mode	Bit1~Bit0: acc/dec mode 00: linear acc/dec 01: S curve acc/dec 10: sine curve acc/dec 11: reserved Bit15~Bit2: reserved
SFD1756	Max speed low 16-bit	
SFD1757	Max speed high 16-bit	
SFD1758	Initial speed low 16-bit	
SFD1759	Initial speed high 16-bit	
SFD1760	Stop speed low 16-bit	
SFD1761	Stop speed high 16-bit	
SFD1762	Follow performance	1~100, 100 means the time constant is 1 Tick, 1 means the time constant is 100 Ticks
SFD1763	Follow feedforward compensation	0~100, %
...		
<b>Y6 (group 3 parameters)</b>		
SFD1770	Pulse default speed low 16-bit	Pulse is sent at the default speed when the speed is 0.
SFD1771	Pulse default speed high 16-bit	

SFD1772	Acceleration time of pulse default speed	
SFD1773	deceleration time of pulse default speed	
SFD1774	Accerlation and deceleration time	
SFD1775	Acceleration/deceleration mode	Bit1~Bit0: acc/dec mode 00: linear acc/dec 01: S curve acc/dec 10: sine curve acc/dec 11: reserved Bit15~Bit2: reserved
SFD1776	Max speed low 16-bit	
SFD1777	Max speed high 16-bit	
SFD1778	Initial speed low 16-bit	
SFD1779	Initial speed high 16-bit	
SFD1780	Stop speed low 16-bit	
SFD1781	Stop speed high 16-bit	
SFD1782	Follow performance	1~100, 100 means the time constant is 1 Tick, 1 means the time constant is 100 Ticks
SFD1783	Follow feedforward compensation	0~100, %
...		
<b>Y6 (group 4 parameters)</b>		
SFD1790	Pulse default speed low 16-bit	Pulse is sent at the default speed when the speed is 0.
SFD1791	Pulse default speed high 16-bit	
SFD1792	Acceleration time of pulse default speed	
SFD1793	deceleration time of pulse default speed	
SFD1794	Accerlation and deceleration time	
SFD1795	Acceleration/deceleration mode	Bit1~Bit0: acc/dec mode 00: linear acc/dec 01: S curve acc/dec 10: sine curve acc/dec 11: reserved Bit15~Bit2: reserved
SFD1796	Max speed low 16-bit	
SFD1797	Max speed high 16-bit	
SFD1798	Initial speed low 16-bit	
SFD1799	Initial speed high 16-bit	
SFD1800	Stop speed low 16-bit	
SFD1801	Stop speed high 16-bit	
SFD1802	Follow performance	1~100, 100 means the time constant is 1 Tick, 1 means the time constant is 100 Ticks

SFD1803	Follow feedforward compensation	0~100, %
...		
<b>Y7 (common parameters)</b>		
SFD1810	Pulse parameters	Same to SFD900
SFD1811	Pulse sending mode	Bit 0: pulse sending mode 0: complete mode; 1: continue mode Default is 0
SFD1812	Pulse number/1 rotation low 16-bit	
SFD1813	Pulse number/1 rotation high 16-bit	
SFD1814	Moving amount/1 rotation low 16-bit	
SFD1815	Moving amount/1 rotation high 16-bit	
SFD1816	Pulse direction terminal	Appoint to Y terminal, 0xFF is no terminal
SFD1817	Direction delay time	Default is 20, unit: ms
SFD1818	Gear clearance positive compensation	
SFD1819	Gear clearance negative compensation	
SFD1820	Electrical origin position low 16-bit	
SFD1821	Electrical origin position high 16-bit	
SFD1822	Signal terminal switch state	Bit0: Origin Signal Switch State Settings Bit1: Z Phase Switch State Settings Bit2: Positive Limit Switching State Settings Bit3: Negative Limit Switching State Settings 0: Normally open (positive logic), 1: Normally closed (negative logic); default is 0
SFD1824	Near-point signal terminal setting	
SFD1825	Z phase terminal setting	Bit0~Bit7: Specify the number of the X terminal, 0xFF is no terminal
SFD1827	Limit terminal setting	Bit7~Bit0: Specifies the X terminal number of the positive limit, and 0xFF is no terminal. Bit15~Bit8: Specifies the X terminal number of the negative limit, and 0xFF is no terminal.
SFD1828	Zero clear CLR output signal	
SFD1829	Return speed VH low 16-bit	Bit0~Bit7: Specify the number of the Y terminal, 0xFF is no terminal
SFD1832	Return speed VH high 16-bit	
SFD1833	Creeping speed VC low 16-bit	
SFD1834	Creeping speed VC high 16-bit	
SFD1835	Mechanical origin position low 16-bit	



SFD1836	Mechanical origin position high 16-bit	
SFD1837	Z phase number	
SFD1838	CLR signal delay time	Default is 20, unit: ms
SFD1839	Grinding wheel radius (polar coordinates)	Low 16-bit
SFD1840		High 16-bit
SFD1841	Soft limit positive value	Low 16-bit
SFD1842		High 16-bit
SFD1843	Soft limit negative value	Low 16-bit
...		
<b>Y7 (group 1 parameters)</b>		
SFD1860	Pulse default speed low 16-bit	Pulse is sent at the default speed when the speed is 0.
SFD1861	Pulse default speed high 16-bit	
SFD1862	Acceleration time of pulse default speed	
SFD1863	deceleration time of pulse default speed	
SFD1864	Accerlation and deceleration time	
SFD1865	Acceleration/deceleration mode	Bit1~Bit0: acc/dec mode 00: linear acc/dec 01: S curve acc/dec 10: sine curve acc/dec 11: reserved Bit15~Bit2: reserved
SFD1866	Max speed low 16-bit	
SFD1867	Max speed high 16-bit	
SFD1868	Initial speed low 16-bit	
SFD1869	Initial speed high 16-bit	
SFD1870	Stop speed low 16-bit	
SFD1871	Stop speed high 16-bit	
SFD1872	Follow performance	1~100, 100 means the time constant is 1 Tick, 1 means the time constant is 100 Ticks
SFD1873	Follow feedforward compensation	0~100, %
...		
<b>Y7 (group 2 parameters)</b>		
SFD1880	Pulse default speed low 16-bit	Pulse is sent at the default speed when the speed is 0.
SFD1881	Pulse default speed high 16-bit	
SFD1882	Acceleration time of pulse default speed	
SFD1883	deceleration time of pulse default speed	
SFD1884	Accerlation and deceleration time	

SFD1885	Acceleration/deceleration mode	Bit1~Bit0: acc/dec mode 00: linear acc/dec 01: S curve acc/dec 10: sine curve acc/dec 11: reserved Bit15~Bit2: reserved
SFD1886	Max speed low 16-bit	
SFD1887	Max speed high 16-bit	
SFD1888	Initial speed low 16-bit	
SFD1889	Initial speed high 16-bit	
SFD1890	Stop speed low 16-bit	
SFD1891	Stop speed high 16-bit	
SFD1892	Follow performance	1~100, 100 means the time constant is 1 Tick, 1 means the time constant is 100 Ticks
SFD1893	Follow feedforward compensation	0~100, %
...		
<b>Y7 (group 3 parameters)</b>		
SFD1900	Pulse default speed low 16-bit	Pulse is sent at the default speed when the speed is 0.
SFD1901	Pulse default speed high 16-bit	
SFD1902	Acceleration time of pulse default speed	
SFD1903	deceleration time of pulse default speed	
SFD1904	Accerlation and deceleration time	
SFD1905	Acceleration/deceleration mode	Bit1~Bit0: acc/dec mode 00: linear acc/dec 01: S curve acc/dec 10: sine curve acc/dec 11: reserved Bit15~Bit2: reserved
SFD1906	Max speed low 16-bit	
SFD1907	Max speed high 16-bit	
SFD1908	Initial speed low 16-bit	
SFD1909	Initial speed high 16-bit	
SFD1910	Stop speed low 16-bit	
SFD1911	Stop speed high 16-bit	
SFD1912	Follow performance	1~100, 100 means the time constant is 1 Tick, 1 means the time constant is 100 Ticks
SFD1913	Follow feedforward compensation	0~100, %
...		
<b>Y7 (group 4 parameters)</b>		
SFD1920	Pulse default speed low 16-bit	Pulse is sent at the default speed when the speed is 0.
SFD1921	Pulse default speed high 16-bit	

SFD1922	Acceleration time of pulse default speed	
SFD1923	deceleration time of pulse default speed	
SFD1924	Accerlation and deceleration time	
SFD1925	Acceleration/deceleration mode	Bit1~Bit0: acc/dec mode 00: linear acc/dec 01: S curve acc/dec 10: sine curve acc/dec 11: reserved Bit15~Bit2: reserved
SFD1926	Max speed low 16-bit	
SFD1927	Max speed high 16-bit	
SFD1928	Initial speed low 16-bit	
SFD1929	Initial speed high 16-bit	
SFD1930	Stop speed low 16-bit	
SFD1931	Stop speed high 16-bit	
SFD1932	Follow performance	1~100, 100 means the time constant is 1 Tick, 1 means the time constant is 100 Ticks
SFD1933	Follow feedforward compensation	0~100, %
...		
<b>Y10 (common parameters)</b>		
SFD1940	Pulse parameters	Same to SFD900
SFD1941	Pulse sending mode	Bit 0: pulse sending mode 0: complete mode; 1: continue mode Default is 0
SFD1942	Pulse number/1 rotation low 16-bit	
SFD1943	Pulse number/1 rotation high 16-bit	
SFD1944	Moving amount/1 rotation low 16-bit	
SFD1945	Moving amount/1 rotation high 16-bit	
SFD1946	Pulse direction terminal	Appoint to Y terminal, 0xFF is no terminal
SFD1947	Direction delay time	Default is 20, unit: ms
SFD1948	Gear clearance positive compensation	
SFD1949	Gear clearance negative compensation	
SFD1950	Electrical origin position low 16-bit	
SFD1951	Electrical origin position high 16-bit	

SFD1952	Signal terminal switch state	Bit0: Origin Signal Switch State Settings Bit1: Z Phase Switch State Settings Bit2: Positive Limit Switching State Settings Bit3: Negative Limit Switching State Settings 0: Normally open (positive logic), 1: Normally closed (negative logic); default is 0
SFD1954	Near-point signal terminal setting	
SFD1955	Z phase terminal setting	Bit0~Bit7: Specify the number of the X terminal, 0xFF is no terminal
SFD1957	Limit terminal setting	Bit7~Bit0: Specifies the X terminal number of the positive limit, and 0xFF is no terminal. Bit15~Bit8: Specifies the X terminal number of the negative limit, and 0xFF is no terminal.
SFD1958	Zero clear CLR output signal	Bit0~Bit7: Specify the number of the Y terminal, 0xFF is no terminal
SFD1959	Return speed VH low 16-bit	
SFD1962	Return speed VH high 16-bit	
SFD1963	Creeping speed VC low 16-bit	
SFD1964	Creeping speed VC high 16-bit	
SFD1965	Mechanical origin position low 16-bit	
SFD1966	Mechanical origin position high 16-bit	
SFD1967	Z phase number	
SFD1968	CLR signal delay time	Default is 20, unit: ms
SFD1969	Grinding wheel radius (polar coordinates)	Low 16-bit
SFD1970		High 16-bit
SFD1971	Soft limit positive value	Low 16-bit
SFD1972		High 16-bit
SFD1973	Soft limit negative value	Low 16-bit
...		
<b>Y10 (group 1 parameters)</b>		
SFD1990	Pulse default speed low 16-bit	Pulse is sent at the default speed when the speed is 0.
SFD1991	Pulse default speed high 16-bit	
SFD1992	Acceleration time of pulse default speed	
SFD1993	deceleration time of pulse default speed	
SFD1994	Accerlation and deceleration time	

SFD1995	Acceleration/deceleration mode	Bit1~Bit0: acc/dec mode 00: linear acc/dec 01: S curve acc/dec 10: sine curve acc/dec 11: reserved Bit15~Bit2: reserved
SFD1996	Max speed low 16-bit	
SFD1997	Max speed high 16-bit	
SFD1998	Initial speed low 16-bit	
SFD1999	Initial speed high 16-bit	
SFD2000	Stop speed low 16-bit	
SFD2001	Stop speed high 16-bit	
SFD2002	Follow performance	1~100, 100 means the time constant is 1 Tick, 1 means the time constant is 100 Ticks
SFD2003	Follow feedforward compensation	0~100, %
...		
<b>Y10 (group 2 parameters)</b>		
SFD2010	Pulse default speed low 16-bit	Pulse is sent at the default speed when the speed is 0.
SFD2011	Pulse default speed high 16-bit	
SFD2012	Acceleration time of pulse default speed	
SFD2013	deceleration time of pulse default speed	
SFD2014	Accerlation and deceleration time	
SFD2015	Acceleration/deceleration mode	Bit1~Bit0: acc/dec mode 00: linear acc/dec 01: S curve acc/dec 10: sine curve acc/dec 11: reserved Bit15~Bit2: reserved
SFD2016	Max speed low 16-bit	
SFD2017	Max speed high 16-bit	
SFD2018	Initial speed low 16-bit	
SFD2019	Initial speed high 16-bit	
SFD2020	Stop speed low 16-bit	
SFD2021	Stop speed high 16-bit	
SFD2022	Follow performance	1~100, 100 means the time constant is 1 Tick, 1 means the time constant is 100 Ticks
SFD2023	Follow feedforward compensation	0~100, %
...		
<b>Y10 (group 3 parameters)</b>		
SFD2030	Pulse default speed low 16-bit	Pulse is sent at the default speed when the speed is 0.
SFD2031	Pulse default speed high 16-bit	

SFD2032	Acceleration time of pulse default speed	
SFD2033	deceleration time of pulse default speed	
SFD2034	Accerlation and deceleration time	
SFD2035	Acceleration/deceleration mode	Bit1~Bit0: acc/dec mode 00: linear acc/dec 01: S curve acc/dec 10: sine curve acc/dec 11: reserved Bit15~Bit2: reserved
SFD2036	Max speed low 16-bit	
SFD2037	Max speed high 16-bit	
SFD2038	Initial speed low 16-bit	
SFD2039	Initial speed high 16-bit	
SFD2040	Stop speed low 16-bit	
SFD2041	Stop speed high 16-bit	
SFD2042	Follow performance	1~100, 100 means the time constant is 1 Tick, 1 means the time constant is 100 Ticks
SFD2043	Follow feedforward compensation	0~100, %
...		
<b>Y10 (group 4 parameters)</b>		
SFD2050	Pulse default speed low 16-bit	Pulse is sent at the default speed when the speed is 0.
SFD2051	Pulse default speed high 16-bit	
SFD2052	Acceleration time of pulse default speed	
SFD2053	deceleration time of pulse default speed	
SFD2054	Accerlation and deceleration time	
SFD2055	Acceleration/deceleration mode	Bit1~Bit0: acc/dec mode 00: linear acc/dec 01: S curve acc/dec 10: sine curve acc/dec 11: reserved Bit15~Bit2: reserved
SFD2056	Max speed low 16-bit	
SFD2057	Max speed high 16-bit	
SFD2058	Initial speed low 16-bit	
SFD2059	Initial speed high 16-bit	
SFD2060	Stop speed low 16-bit	
SFD2061	Stop speed high 16-bit	
SFD2062	Follow performance	1~100, 100 means the time constant is 1 Tick, 1 means the time constant is 100 Ticks

SFD2063	Follow feedforward compensation	0~100, %
...		
<b>Y11 (common parameters)</b>		
SFD2070	Pulse parameters	Same to SFD900
SFD2071	Pulse sending mode	Bit 0: pulse sending mode 0: complete mode; 1: continue mode Default is 0
SFD2072	Pulse number/1 rotation low 16-bit	
SFD2073	Pulse number/1 rotation high 16-bit	
SFD2074	Moving amount/1 rotation low 16-bit	
SFD2075	Moving amount/1 rotation high 16-bit	
SFD2076	Pulse direction terminal	Appoint to Y terminal, 0xFF is no terminal
SFD2077	Direction delay time	Default is 20, unit: ms
SFD2078	Gear clearance positive compensation	
SFD2079	Gear clearance negative compensation	
SFD2080	Electrical origin position low 16-bit	
SFD2081	Electrical origin position high 16-bit	
SFD2082	Signal terminal switch state	Bit0: Origin Signal Switch State Settings Bit1: Z Phase Switch State Settings Bit2: Positive Limit Switching State Settings Bit3: Negative Limit Switching State Settings 0: Normally open (positive logic), 1: Normally closed (negative logic); default is 0
SFD2084	Near-point signal terminal setting	
SFD2085	Z phase terminal setting	Bit0~Bit7: Specify the number of the X terminal, 0xFF is no terminal
SFD2087	Limit terminal setting	Bit7~Bit0: Specifies the X terminal number of the positive limit, and 0xFF is no terminal. Bit15~Bit8: Specifies the X terminal number of the negative limit, and 0xFF is no terminal.
SFD2088	Zero clear CLR output signal	Bit0~Bit7: Specify the number of the Y terminal, 0xFF is no terminal
SFD2089	Return speed VH low 16-bit	
SFD2092	Return speed VH high 16-bit	
SFD2093	Creeping speed VC low 16-bit	
SFD2094	Creeping speed VC high 16-bit	
SFD2095	Mechanical origin position low 16-bit	

SFD2096	Mechanical origin position high 16-bit	
SFD2097	Z phase number	
SFD2098	CLR signal delay time	Default is 20, unit: ms
SFD2099	Grinding wheel radius (polar coordinates)	Low 16-bit
SFD2100		High 16-bit
SFD2101	Soft limit positive value	Low 16-bit
SFD2102		High 16-bit
SFD2103	Soft limit negative value	Low 16-bit
...		
<b>Y11 (group 1 parameters)</b>		
SFD2120	Pulse default speed low 16-bit	Pulse is sent at the default speed when the speed is 0.
SFD2121	Pulse default speed high 16-bit	
SFD2122	Acceleration time of pulse default speed	
SFD2123	deceleration time of pulse default speed	
SFD2124	Accerlation and deceleration time	
SFD2125	Acceleration/deceleration mode	Bit1~Bit0: acc/dec mode 00: linear acc/dec 01: S curve acc/dec 10: sine curve acc/dec 11: reserved Bit15~Bit2: reserved
SFD2126	Max speed low 16-bit	
SFD2127	Max speed high 16-bit	
SFD2128	Initial speed low 16-bit	
SFD2129	Initial speed high 16-bit	
SFD2130	Stop speed low 16-bit	
SFD2131	Stop speed high 16-bit	
SFD2132	Follow performance	1~100, 100 means the time constant is 1 Tick, 1 means the time constant is 100 Ticks
SFD2133	Follow feedforward compensation	0~100, %
...		
<b>Y11 (group 2 parameters)</b>		
SFD2140	Pulse default speed low 16-bit	Pulse is sent at the default speed when the speed is 0.
SFD2141	Pulse default speed high 16-bit	
SFD2142	Acceleration time of pulse default speed	
SFD2143	deceleration time of pulse default speed	
SFD2144	Accerlation and deceleration time	



SFD2145	Acceleration/deceleration mode	Bit1~Bit0: acc/dec mode 00: linear acc/dec 01: S curve acc/dec 10: sine curve acc/dec 11: reserved Bit15~Bit2: reserved
SFD2146	Max speed low 16-bit	
SFD2147	Max speed high 16-bit	
SFD2148	Initial speed low 16-bit	
SFD2149	Initial speed high 16-bit	
SFD2150	Stop speed low 16-bit	
SFD2151	Stop speed high 16-bit	
SFD2152	Follow performance	1~100, 100 means the time constant is 1 Tick, 1 means the time constant is 100 Ticks
SFD2153	Follow feedforward compensation	0~100, %
...		
<b>Y11 (group 3 parameters)</b>		
SFD2160	Pulse default speed low 16-bit	Pulse is sent at the default speed when the speed is 0.
SFD2161	Pulse default speed high 16-bit	
SFD2162	Acceleration time of pulse default speed	
SFD2163	deceleration time of pulse default speed	
SFD2164	Accerlation and deceleration time	
SFD2165	Acceleration/deceleration mode	Bit1~Bit0: acc/dec mode 00: linear acc/dec 01: S curve acc/dec 10: sine curve acc/dec 11: reserved Bit15~Bit2: reserved
SFD2166	Max speed low 16-bit	
SFD2167	Max speed high 16-bit	
SFD2168	Initial speed low 16-bit	
SFD2169	Initial speed high 16-bit	
SFD2170	Stop speed low 16-bit	
SFD2171	Stop speed high 16-bit	
SFD2172	Follow performance	1~100, 100 means the time constant is 1 Tick, 1 means the time constant is 100 Ticks
SFD2173	Follow feedforward compensation	0~100, %
...		
<b>Y11 (group 4 parameters)</b>		
SFD2180	Pulse default speed low 16-bit	Pulse is sent at the default speed when the speed is 0.
SFD2181	Pulse default speed high 16-bit	

SFD2182	Acceleration time of pulse default speed	
SFD2183	deceleration time of pulse default speed	
SFD2184	Accerlation and deceleration time	
SFD2185	Acceleration/deceleration mode	Bit1~Bit0: acc/dec mode 00: linear acc/dec 01: S curve acc/dec 10: sine curve acc/dec 11: reserved Bit15~Bit2: reserved
SFD2186	Max speed low 16-bit	
SFD2187	Max speed high 16-bit	
SFD2188	Initial speed low 16-bit	
SFD2189	Initial speed high 16-bit	
SFD2190	Stop speed low 16-bit	
SFD2191	Stop speed high 16-bit	
SFD2192	Follow performance	1~100, 100 means the time constant is 1 Tick, 1 means the time constant is 100 Ticks
SFD2193	Follow feedforward compensation	0~100, %
...		

## Appendix 4. External interruption terminal list

XD series PLC external interrupt terminal allocation is as follows:

### XD/XL series 10 I/O

Input terminal	Pointer		Disable interruption instruction
	Rising interruption	Falling interruption	
X2	I0000	I0001	SM050
X3	I0100	I0101	SM051
X4	I0200	I0201	SM052

### XD/XL series 16 I/O

Input terminal	Pointer		Disable interruption instruction
	Rising interruption	Falling interruption	
X2	I0000	I0001	SM050
X3	I0100	I0101	SM051
X4	I0200	I0201	SM052
X5	I0300	I0301	SM053
X6	I0400	I0401	SM054
X7	I0500	I0501	SM055

### XD/XL series 24~64 I/O

Input terminal	Pointer		Disable interruption instruction
	Rising interruption	Falling interruption	
X2	I0000	I0001	SM050
X3	I0100	I0101	SM051
X4	I0200	I0201	SM052
X5	I0300	I0301	SM053
X6	I0400	I0401	SM054
X7	I0500	I0501	SM055
X10	I0600	I0601	SM056
X11	I0700	I0701	SM057
X12	I0800	I0801	SM058
X13	I0900	I0901	SM059

### Appendix 5. PLC resource conflict table

When PLC is used in practice, conflicts may arise due to the simultaneous use of some resources. This section will list the resources that may cause conflicts in each PLC model. This part mainly refers to high-speed counting, accurate timing and pulse output.

	Precise timing	High speed counter				Pulse output	
XD2-16, XD3-16, XD5-16, XL3-16, XL5-16, XL5E-16							
	ET0	-	-	-	-	-	-
	ET2						
	ET4						
	ET6						
	ET8	HSC0					
	ET10		HSC2				
	ET12			HSC4			
	ET14					Y0	
	ET16					Y0	
	ET18					Y1	
	ET20					Y1	
	ET22						
	ET24						
XD3-24/32/48/60, ZG3-30							
	ET0						
	ET2						
	ET4						
	ET6						
	ET8						
	ET10						
	ET12	HSC0					
	ET14		HSC2				
	ET16			HSC4			
	ET18					Y0	
	ET20					Y0	
	ET22					Y1	
	ET24					Y1	
XD5-24/32/48/60, XDM-24/32/48/60, XD5E-30/60, XDME-60, XL5-32, XL5E-32, XLME-32							
	ET0	-	-	-	-	-	-
	ET2				HSC6		
	ET4			HSC4			
	ET6		HSC2				
	ET8	HSC0					

	ET10					Y3	
	ET12					Y3	
	ET14					Y2	
	ET16					Y2	
	ET18					Y1	
	ET20					Y1	
	ET22					Y0	
	ET24					Y0	
XDC-24/32/48/60							
	ET0	-	-	-	HSC6	-	-
	ET2			HSC4			
	ET4		HSC2				
	ET6	HSC0					
	ET8					Y3	
	ET10					Y3	
	ET12					Y2	
	ET14					Y2	
	ET16					Y1	
	ET18					Y1	
	ET20					Y0	
	ET22					Y0	
	ET24						

---

※1: This form should be read horizontally. Any two resources in each row cannot be used at the same time. Otherwise, it will cause conflict.

---



**XINJE**



**WE CHAT ID**

**WUXI XINJE ELECTRIC CO., LTD.**

4th Floor Building 7,Originality Industry  
park, Liyuan Development Zone, Wuxi City,  
Jiangsu Province

214072

Tel: 400-885-0136

Fax: (510) 85111290